



japanese english



OVER 6,000 WORDS
AND PHRASES

BILINGUAL
DICTIONARY

JAPANESE
ENGLISH



BILINGUAL
VISUAL
DICTIONARY



BILINGUAL
VISUAL
DICTIONARY





London, New York, Melbourne, Munich, Delhi

Senior Editor Angela Wilkes
Project Art Editor Katie Eke
Production Editor Luca Frassinetti
Production Controller Linda Dare
Managing Art Editor Lee Griffiths
Managing Editor Stephanie Farrow
US Editor Jill Hamilton

Designed for Dorling Kindersley by WaltonCreative.com

Art Editor Colin Walton, assisted by Tracy Musson
Designers Peter Radcliffe, Earl Neish, Ann Cannings
Picture Research Marissa Keating

Language content for Dorling Kindersley by
g-and-w PUBLISHING

Managed by Jane Wightwick
Translation by Kazumi Honda
Layout by Mark Wightwick
Editing by Cheryl Hutty

First American Edition, 2011

Published in the United States by DK Publishing,
375 Hudson Street, New York, New York 10014

11 12 13 14 15 10 9 8 7 6 5 4 3 2 1
001—179043—May/2011

Copyright © 2011 Dorling Kindersley Limited
All rights reserved.

Without limiting the rights under copyright reserved above,
no part of this publication may be reproduced, stored
in or introduced into a retrieval system, or transmitted
in any form, or by any means (electronic, mechanical,
photocopying, recording, or otherwise) without the prior
written permission of both the copyright owner and the
above publisher of this book.

Published in Great Britain by Dorling Kindersley Limited.

A catalog record for this book is available from
the Library of Congress.

ISBN 978-0-7566-7556-1

DK books are available at special discounts when purchased in bulk
for sales promotions, premiums, fund-raising, or educational use. For
details, contact: DK Publishing Special Markets, 375 Hudson Street,
New York, New York 10014 or SpecialSales@dk.com

Printed and bound in China by L. Rex Printing Co. Ltd.

Discover more at
www.dk.com

目次 mokuji contents

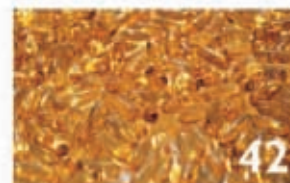

健康
kenkō
health



外食
gaishoku
eating out



娛樂
goraku
leisure



この辞典について
kono jiten nitsuite
about the dictionary



この辞典の使い方
kono jiten no tsukaikata
how to use this book

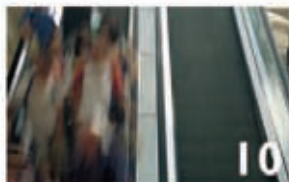

人
hito
people



外観
gaikan
appearance



家庭
katei
home



職務
shokumu
services



買い物
kaimono
shopping



食べ物
tabemono
food



学習
gakushū
study



仕事
shigoto
work



交通
kōtsū
transportation



スポーツ
supōtsu
sports



環境
kankyō
environment



参考資料
sankō shiryō
reference



索引
sakuin
index



謝辞
shaji
acknowledgments

人 hito • people

身体 karada body	12
顔 kao face	14
手 te hand	15
足 ashi foot	15
筋肉 kinniku muscles	16
骨格 kokkaku skeleton	17
内蔵 naizō internal organs	18
生殖器 seishokuki reproductive organs	20
家族 kazoku family	22
人間関係 ningen kankei relationships	24
感情 kanjō emotions	25
人生 jinsei life events	26

外観 gaikan
• appearance

子供服 kodomo fuku children's clothing	30
男性服 dansei fuku men's clothing	32
女性服 josei fuku women's clothing	34
装身具 sōshingu accessories	36
髪 kami hair	38
美容 biyō beauty	40

健康 kenkō • health

病気 byōki illness	44
医者 isha doctor	45
怪我 kega injury	46
応急手当 ōkyū teate first aid	47
病院 byōin hospital	48
歯医者 haisha dentist	50
眼鏡店 megane-ten optician	51
妊娠 ninshin pregnancy	52
出産 shussan childbirth	53
代替療法 daitai ryōhō alternative therapy	54

家庭 katei • home

住宅 jūtaku house	58
住宅内設備 jūtaku-nai setsubi internal systems	60
居間 ima living room	62
ダイニングルーム dainingu rūmu dining room	64
台所 daidokoro kitchen	66
調理用具 chōri yōgu kitchenware	68
寝室 shinshitsu bedroom	70
浴室 yokushitsu bathroom	72
子供部屋 kodomobeya nursery	74
ユティリティルーム yutiriti rūmu utility room	76
作業場 sagyōba workshop	78
道具箱 dōgubako toolbox	80
内装工事 naisō kōji decorating	82
庭 niwa garden	84
庭の植物 niwa no shokubutsu garden plants	86
園芸用品 engei yōhin garden tools	88
園芸 engei gardening	90

職務 shokumu

• services

緊急サービス kinkyū sābisu emergency services	94
銀行 ginkō bank	96
コミュニケーション komyunikēshon communications	98
ホテル hoteru hotel	100

買い物 kaimono

• shopping

ショッピングセンター shoppingu sentā shopping centre	104
デパート depāto department store	105

スーパーマーケット sūpāmāketto supermarket	106
薬局 yakkyoku chemist	108
花屋 hanaya florist	110
新聞販売店 shimbun hambaiten newsagent	112
菓子屋 kashiya confectioner	113
その他の店 sonota no mise other shops	114

食べ物 tabemono
• food

肉 niku meat	118
魚 sakana fish	120
野菜 yasai vegetables	122
果物 kudamono fruit	126
穀類と豆類 kokurui to mamerui grains and legumes	130
ハーブと香辛料 hābu to kōshinryō herbs and spices	132
瓶詰め食品 binzume shokuhin bottled foods	134
乳製品 nyūseihin dairy produce	136
パンと小麦粉 pan to komugiko breads and flours	138
ケーキとデザート kēki to dezāto cakes and desserts	140
デリカテッセン derikatessen delicatessen	142
飲物 nomimono drinks	144

外食 gaishoku

• eating out

カフェ kafe café	148
バー bā bar	150
レストラン resutoran restaurant	152
ファーストフード fāsuto fūdo fast food	154
朝食 chōshoku breakfast	156
食事 shokuji dinner	158

学習 gakushū • study

学校 gakkō school	162
数学 sūgaku math	164
科学 kagaku science	166
大学 daigaku college	168

仕事 shigoto • work

事務所 jimusho office	172
コンピュータ kompyūta computer	176
報道 hōdō media	178
法律 hōritsu law	180
農場 nōjō farm	182
建設 kensetsu construction	186
職業 shokugyō occupations	188

**交通 kōtsū
• transportation**

道路 dōro roads	194
バス basu bus	196
自動車 jidōsha car	198
オートバイ ōtobai motorcycle	204
自転車 jitensha bicycle	206
列車 ressha train	208
航空機 kōkūki aircraft	210
空港 kūkō airport	212
船 fune ship	214
港湾 kōwan port	216

**スポーツ supōtsu
• sports**

アメリカンフットボール amerikan futtobōru American football	220
ラグビー ragubī rugby	221
サッカー sakkā soccer	222
ホッケー hokkē hockey	224
クリケット kuriketto cricket	225

バスケットボール basukettobōru basketball	226
野球 yakyū baseball	228
テニス tenisu tennis	230
ゴルフ gorufu golf	232
陸上競技 rikujō kyōgi track and field	234
格闘技 kakutōgi combat sports	236
水泳 suiei swimming	238
セーリング sēringu sailing	240
乗馬 jōba horseback riding	242
釣り tsuri fishing	244
スキー sukī skiing	246
他のスポーツ ta no supōtsu other sports	248
フィットネス fittonesu fitness	250

娯楽 goraku • leisure

劇場 gekijō theater	254
オーケストラ ōkesutora orchestra	256
コンサート konsāto concert	258
観光 kankō sightseeing	260
野外活動 yagai katsudō outdoor activities	262
海辺 umibe beach	264
キャンプ kyampu camping	266
娯楽家電 goraku kaden home entertainment	268
写真 shashin photography	270
ゲーム gēmu games	272
美術と工芸 bijutsu to kōgei arts and crafts	274

**環境 kankyō
• environment**

宇宙空間 uchūkūkan space	280
地球 chikyū Earth	282
地勢 chisei landscape	284
気象 kishō weather	286



岩石 ganseki rocks	288
鉱石 kōseki minerals	289
動物 dōbutsu animals	290
植物 shokubutsu plants	296
市街 shigai town	298
建築 kenchiku architecture	300

**参考資料 sankō shiryō
• reference**

時間 jikan time	304
カレンダー karendā calendar	306
数字 sūji numbers	308
計量 keiryō weights and measures	310
世界地図 sekai chizu world map	312
不変化詞と反義語 fuhenkashi to hangigo particles and antonyms	320
便利な表現 benri na hyōgen useful phrases	322

この辞典について

情報の理解と記憶に視覚的資料が効果的なことは、既に実証されています。その原理に従って図版を主体に作成された本和英ビジュアル辞典は、広範な分野の実用的現代用語を収録しています。

内容はテーマ別に分けられ、レストラン、ジム、家庭や職場から、動物界や宇宙に至るまで、日常社会のほとんどの分野が詳細に網羅されています。さらに会話と語彙の拡大に役立てられるよう、関連用語や便利な言い回しも付け加えられています。

実用的で使いやすく、見ておもしろい本辞典は、日本語に関心のある方に欠かせない参考資料です。

表記法について

本辞典には、日本で一般に使われている漢字仮名まじり表記が使用されています。魚の名前など、漢字でも仮名でも表記できる言葉は、発音ガイドとして載せたローマ字から仮名の綴りが分かるため、漢字の方を使うようにしました。

発音ガイドには、日本語の学習者なら大抵知っているローマ字が使われています。ローマ字の表記法にはいくつかありますが、本書ではもっとも発音しやすいと思われる方法を選びました。なお、長音は母音の上に長音記号をつけて表記しています。

単語はすべて、次のように漢字・仮名、ローマ字、英語の順で掲載されています。

昼食	旅券
chūshoku	ryoken
lunch	passport

動詞は英語の後に (v) をつけて示しています。

収穫する shūkaku suru | harvest (v)

辞典の後ろには和英別の索引があり、ローマ字または英語で引きたい言葉を調べ、該当する図が載っているページを探することができます。漢字・仮名の書き方を調べる場合は、先ずローマ字または英語の索引を調べ、該当するページをご覧ください。

about the dictionary

The use of pictures is proven to aid understanding and the retention of information. Working on this principle, this highly illustrated English–Japanese bilingual dictionary presents a large range of useful current vocabulary.

The dictionary is divided thematically and covers most aspects of the everyday world in detail, from the restaurant to the gym, the home to the workplace, outer space to the animal kingdom. You will also find additional words and phrases for conversational use and for extending your vocabulary.

This is an essential reference tool for anyone interested in languages—practical, stimulating, and easy-to-use.

A few things to note

The three different writing systems of the Japanese script (*Kanji*, *Katakana*, and *Hiragana*) are employed in the dictionary following common usage. However, where alternative usages exist for individual items of vocabulary (for example animals), we have usually chosen to use Kanji since the pronunciation that follows will indicate the Katakana or Hiragana spellings.

The pronunciation included for the Japanese is shown in *Romaji*, the romanization system that is familiar to most learners of Japanese (see Pronunciation tips).

The entries are always presented in the same order—Japanese, Romaji, English:

昼食	旅券
chūshoku	ryoken
lunch	passport

Verbs are indicated by a (v) after the English, for example:

収穫する shūkaku suru | harvest (v)

Each language also has its own index at the back of the book. Here you can look up a word in either English or Romaji and be referred to the page number(s) where it appears. To reference the Japanese characters, look up a word either in the Romaji or English index and then go to the page indicated.



Pronunciation tips

The pronunciation in the dictionary is shown in the Romaji system. There are some variations possible in Romaji, but we have tried to use the most user-friendly transcription.

Many of the letters used in Romaji can be pronounced as they would be in English, but some require special explanation:

- r Never rolled; pronounced with the tip of the tongue against the gum of the upper front teeth
- f Pronounced more with the lips and less with the teeth than its English equivalent
- w A semi-vowel pronounced with slack lips
- ts As in "pits"
- ei As in "pay" or "rein"
- n/m The Japanese characters ん and ン are generally pronounced "n" as in **さん** san, but this changes to "m" before the sounds "b" or "p," e.g. コンピュータ kompyūta.

Japanese vowels are pronounced short similar to the English "pat/pet/pit/pot/put". However, they can also be lengthened. This is shown in the Japanese script by a dash (一) and in the Romaji by a macron (flat line) over the vowel (ū). Lengthened vowels should have the sound sustained for approximately twice the amount of time.

In general, Japanese words do not have a particular stress, or emphasis. Each syllable is stressed roughly equally. Take care also to pronounce the syllables separately; there are no "silent" letters. For example, カフェ kafe is pronounced "ka-fay" rather than "kayf."

この辞典の使い方

仕事や趣味、海外旅行の準備で初めて日本語を習う方でも、あるいは既に日本語を知っていて語彙を伸ばしたい方でも、本書は大切な学習ツールとして様々な方法で使うことができます。

初心者の方は、同語源語（外来語など異なる言語で語源が共通する言葉）や派生語（同一言語で語源が共通する言葉）に注目すると語彙の習得に便利です。また、こうした学習によって、異なる言語が互いに影響しあっていることも分かってくるでしょう。たとえば日本語には英語圏から流入した食物関連の言葉が多くありますが、一方、日本から英語圏へ流出した技術や大衆文化に関する言葉も多くあります。

実用的な学習方法

- 自宅、職場、学校や大学の構内を歩いているとき、辞典の該当するページを見てください。そして辞典を閉じ、周りを見回して、名前をいえるものがいくつあるか見てみましょう。
- 単語カードを作り、表に英語、裏に漢字や仮名、ローマ字で日本語を書きましょう。単語カードは常に持ち歩き、頻繁に自分でテストしてみましょう。一回テストが終わったら、次のテストの前にカードを入れ替えましょう。
- 特定のページに載っている単語をできるだけたくさん使い、短い物語、手紙、会話文などを書いてみましょう。これは語彙を記憶し、書き方を覚えるのに役立ちます。長い文章を書いてみたい場合は、一つの文に単語を2〜3語使ってみましょう。
- 視覚的記憶に強い方は、紙に図を描くか写し、辞典を閉じて、図の下に単語を書いてみましょう。
- 自信がついてきたら、ローマ字索引から単語を選択し、該当ページの図を見る前に、その意味を覚えているかどうかチェックしましょう。

how to use this book

Whether you are learning a new language for business, pleasure, or in preparation for a vacation abroad, or are hoping to extend your vocabulary in an already familiar language, this dictionary is a valuable learning tool that you can use in a number of different ways.

When learning a new language, look out for cognates (words that are alike in different languages) and derivations (words that share a common root in a particular language). You can also see where the languages have influenced each other. For example, English has imported some terms for food from Japanese but, in turn, has exported many terms used in technology and popular culture.

Practical learning activities

- As you move around your home, workplace, or college, try looking at the pages which cover that setting. You could then close the book, look around you and see how many of the objects and features you can name.
- Make flashcards for yourself with English on one side and Japanese/Romaji on the other side. Carry the cards with you and test yourself frequently, making sure you shuffle them between each test.
- Challenge yourself to write a story, letter, or dialogue using as many of the terms on a particular page as possible. This will help you retain the vocabulary and remember the spelling. If you want to build up to writing a longer text, start with sentences incorporating 2–3 words.
- If you have a very visual memory, try drawing or tracing items from the book onto a piece of paper, then close the book and fill in the words below the picture.
- Once you are more confident, pick out words in the foreign language index and see if you know what they mean before turning to the relevant page to check if you were right.







人 hito
people

身体 karada • body

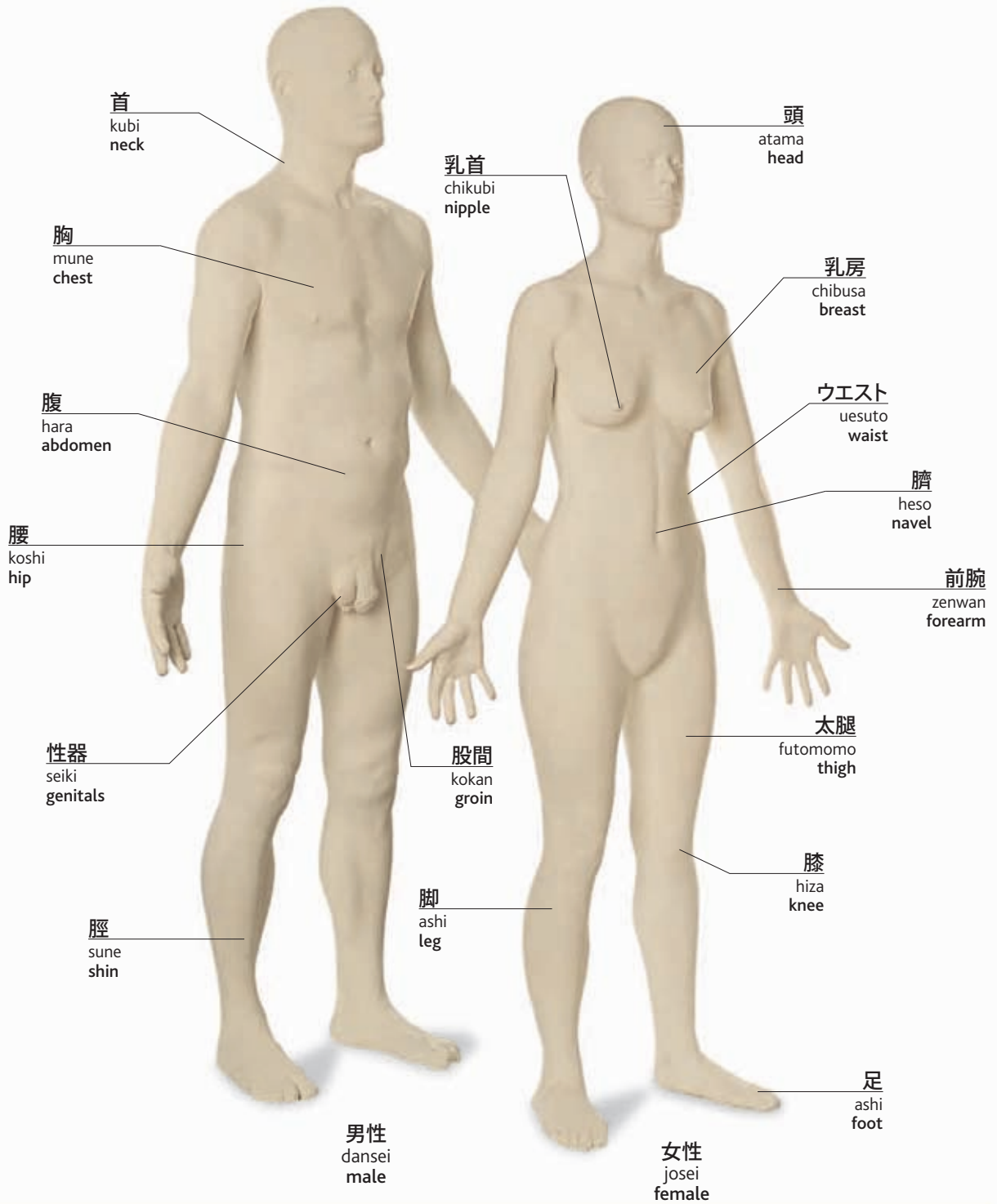

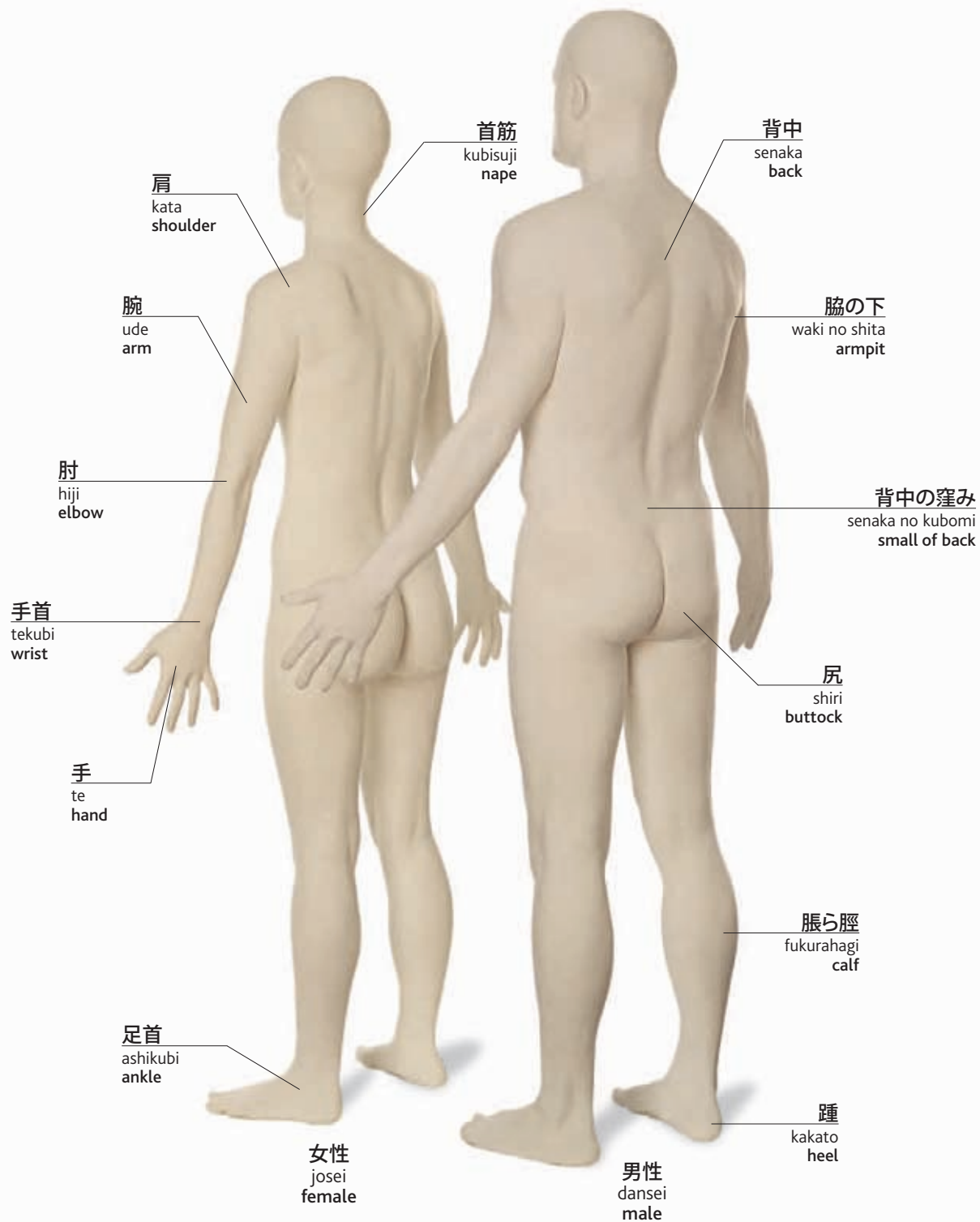

顔 kao • face

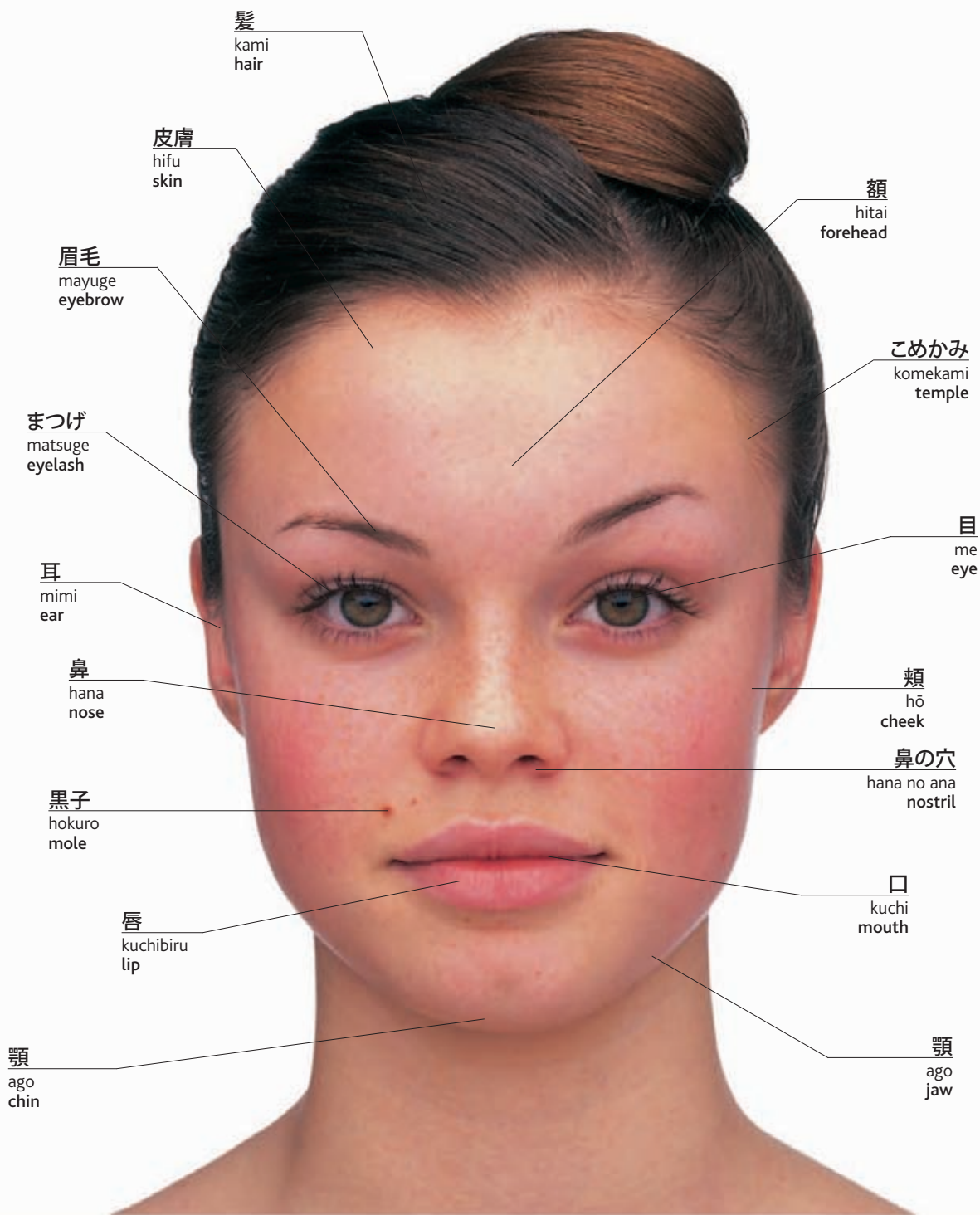



皺
shiwa
wrinkle



そばかす
sobakasu
freckle



毛穴
keana
pore

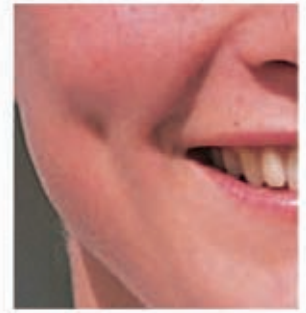

えくぼ
ekubo
dimple

手 te • hand

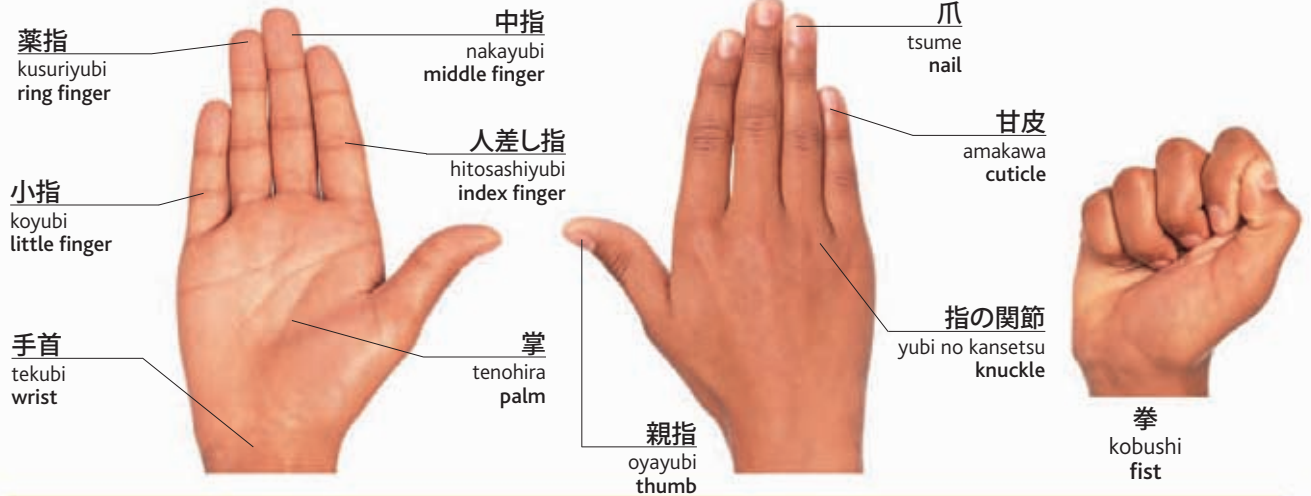

足 ashi • foot



筋肉 kinniku • muscles

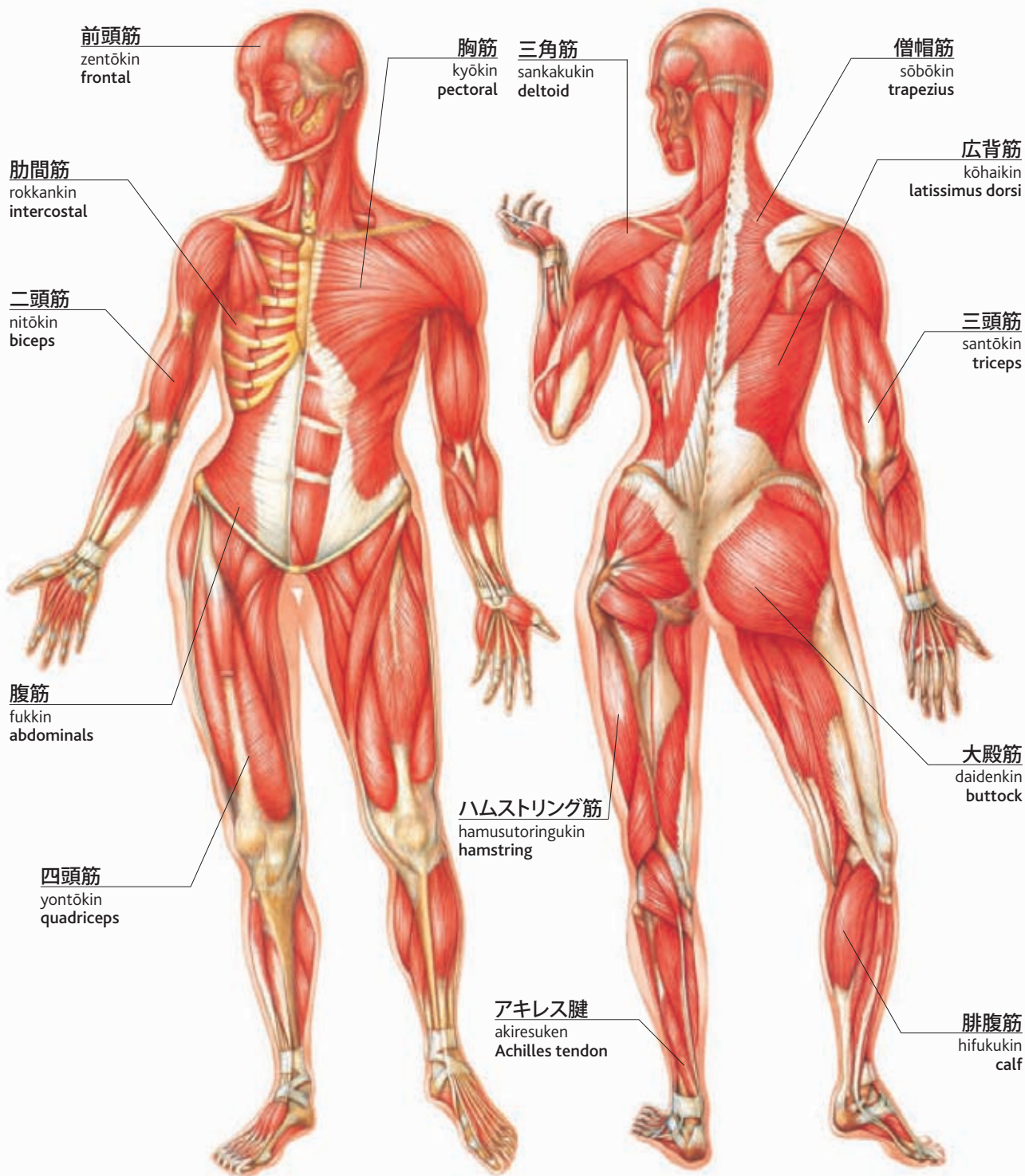

骨格 kokkaku • skeleton

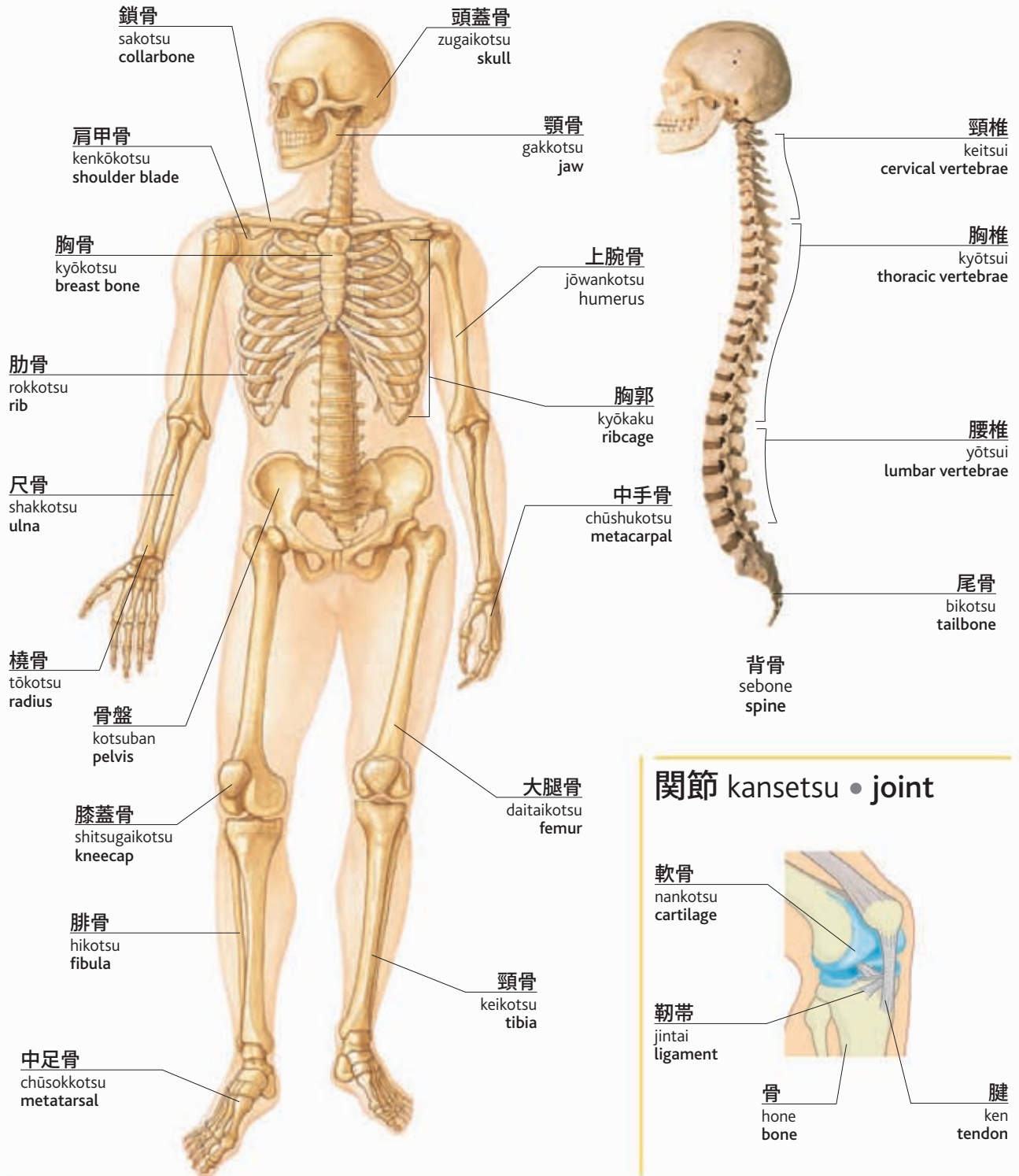

内蔵 naizō • internal organs

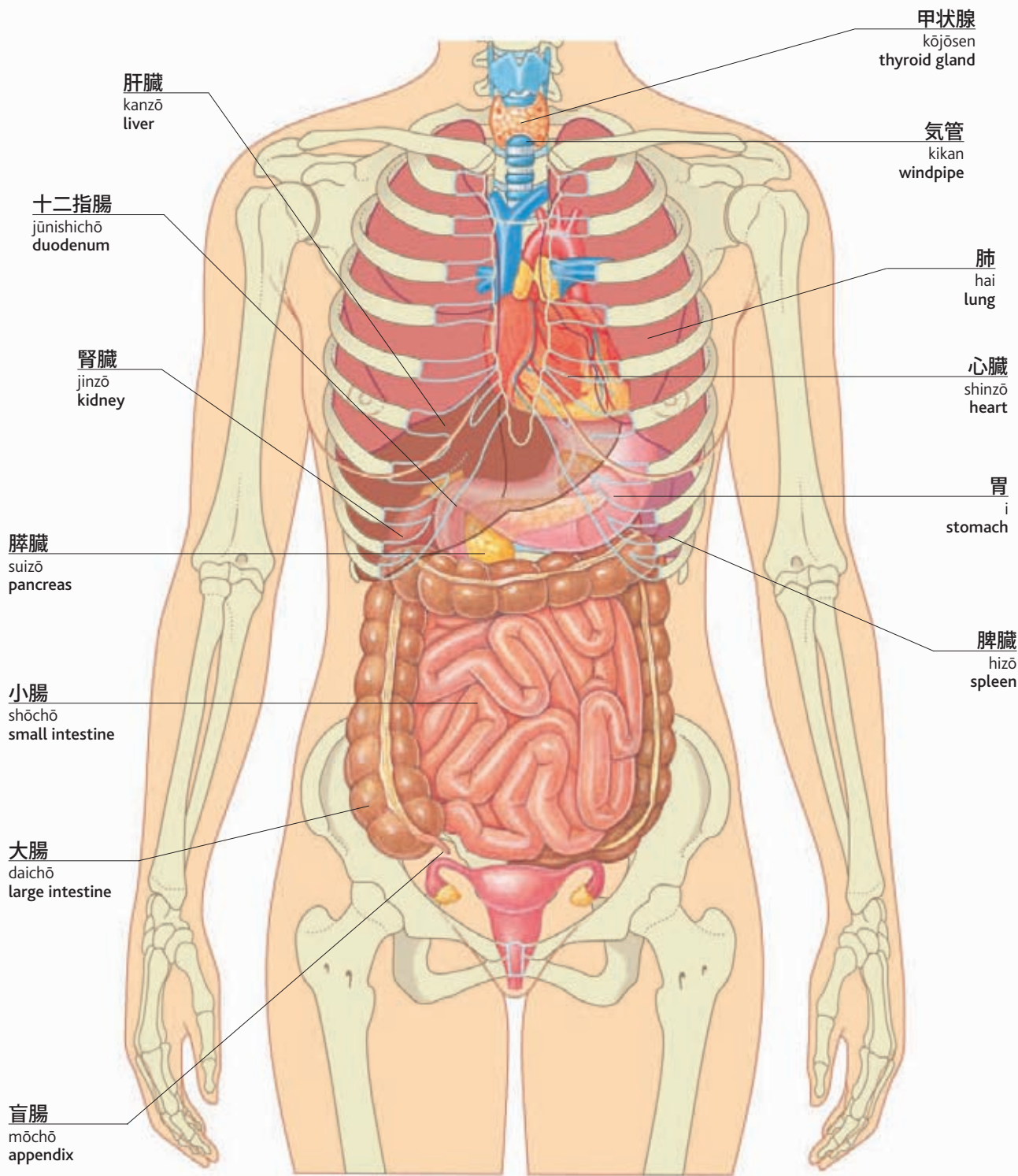

頭 atama • head

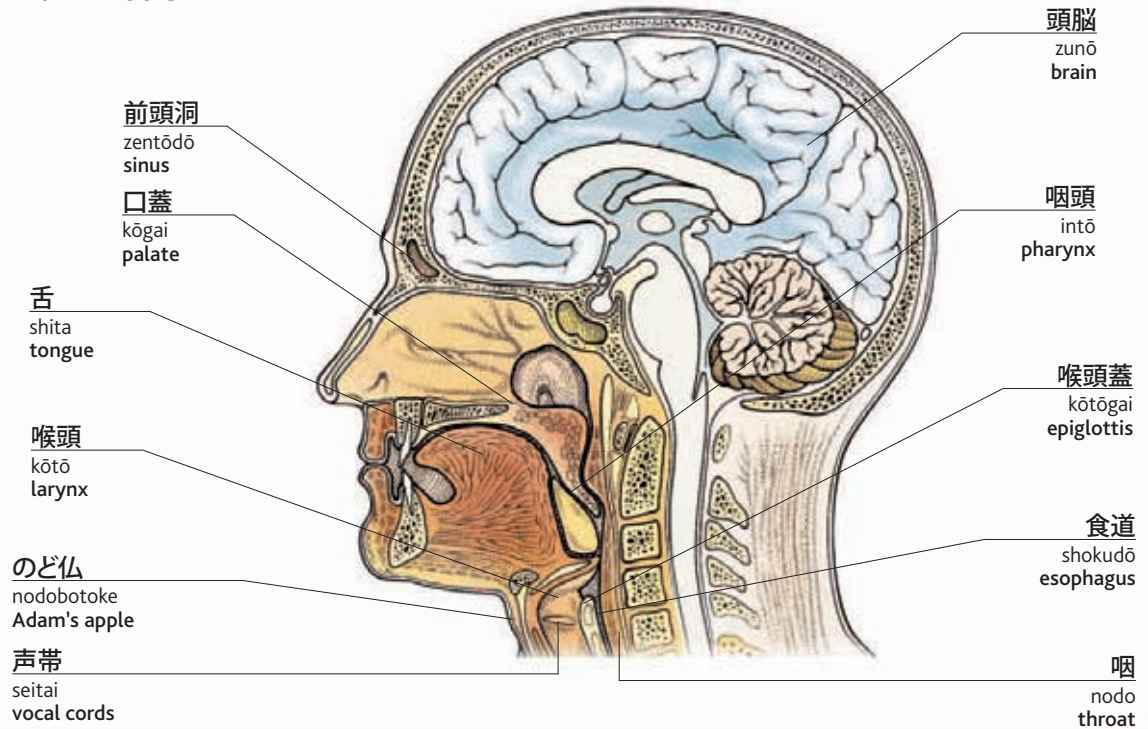

人体系統 jintai keitō • body systems



呼吸器系
kokyūki kei
respiratory

横隔膜
ōkakumaku
diaphragm



消化器系
shōkaki kei
digestive

静脈
jōmyaku
vein



循環系
junkan kei
cardiovascular

動脈
dōmyaku
artery



リンパ系
rimpa kei
lymphatic



泌尿器系
hinyōki kei
urinary

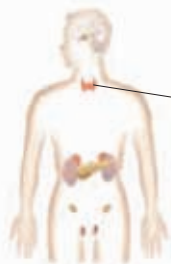

内分泌系
naibumpi kei
endocrine

腺
sen
gland



神経系
shinkei kei
nervous

神経
shinkei
nerve



生殖器系
seishokuki kei
reproductive

生殖器 seishokuki • reproductive organs

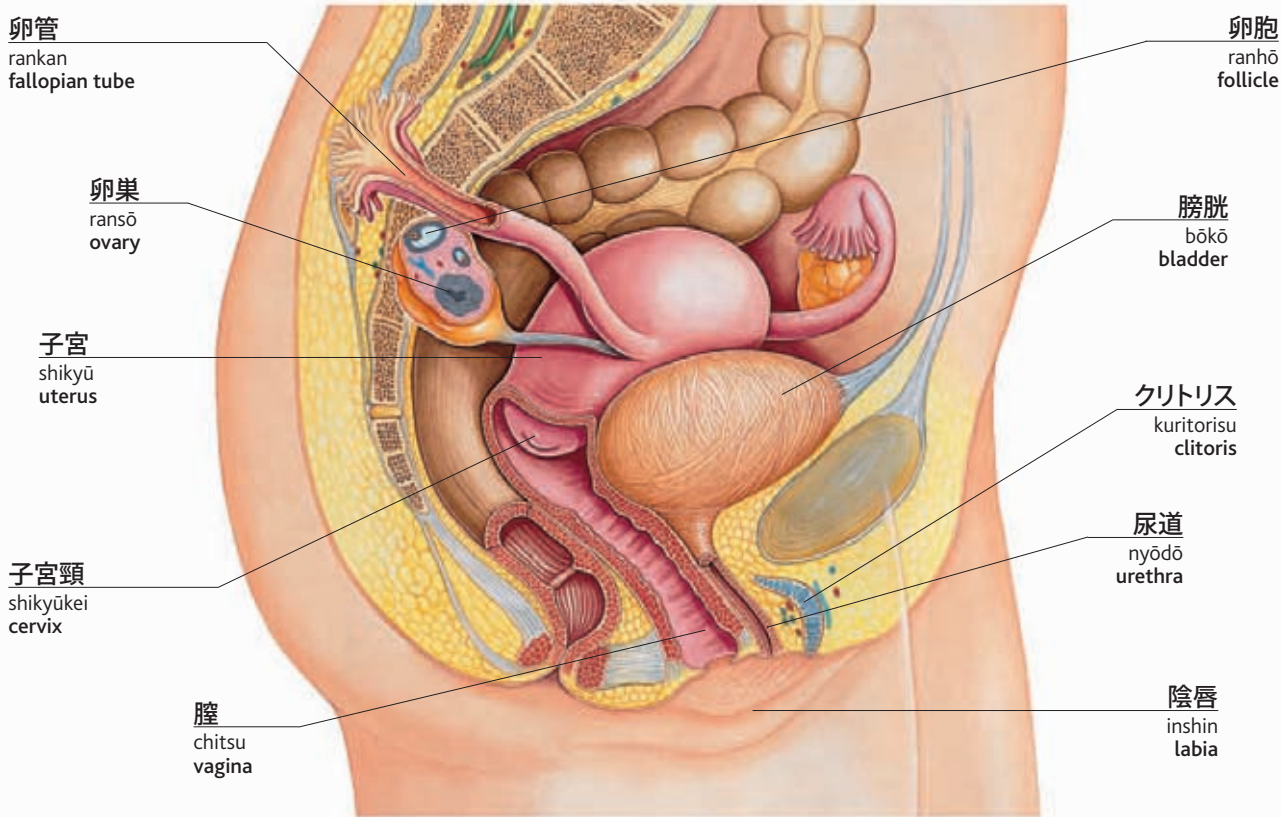

女性 josei | female

生殖 seishoku • reproduction

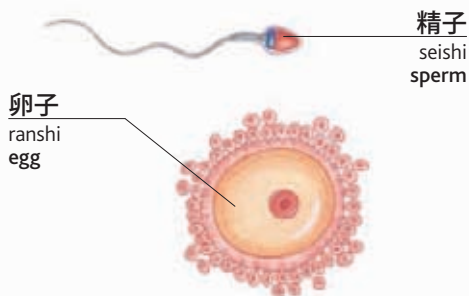

受精 jusei | fertilization

関連用語 kanrenyōgo • vocabulary

ホルモン horumon hormone	不能症 funōshō impotent	妊娠できる ninshin dekiru fertile
排卵 hairan ovulation	妊娠する ninshin suru conceive	月経 gekkei menstruation
不妊症 funinshō infertile	性交 seikō intercourse	性感染症 sei kansenshō sexually transmitted disease

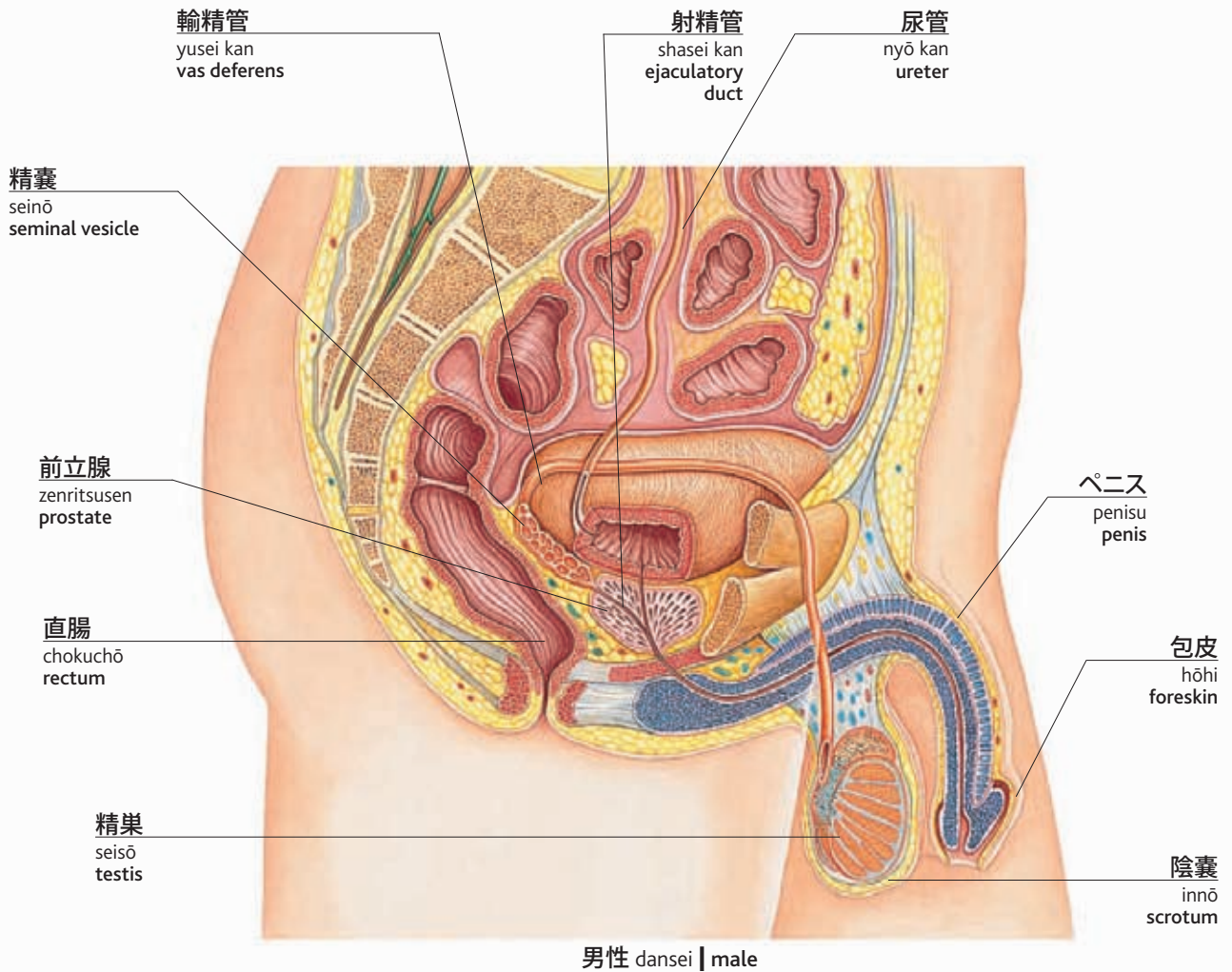

避妊 hinin • contraception

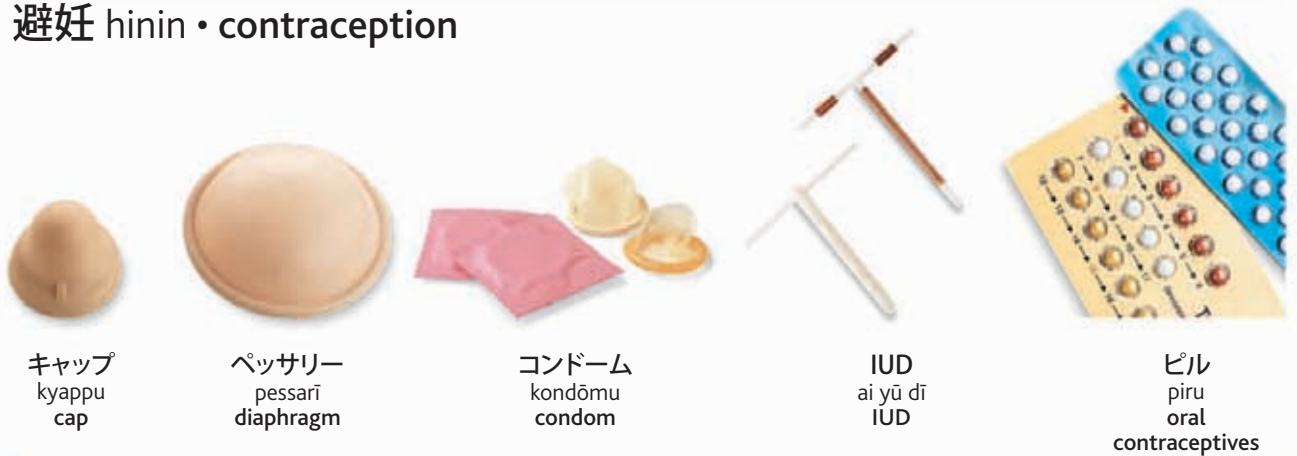

家族 kazoku • family

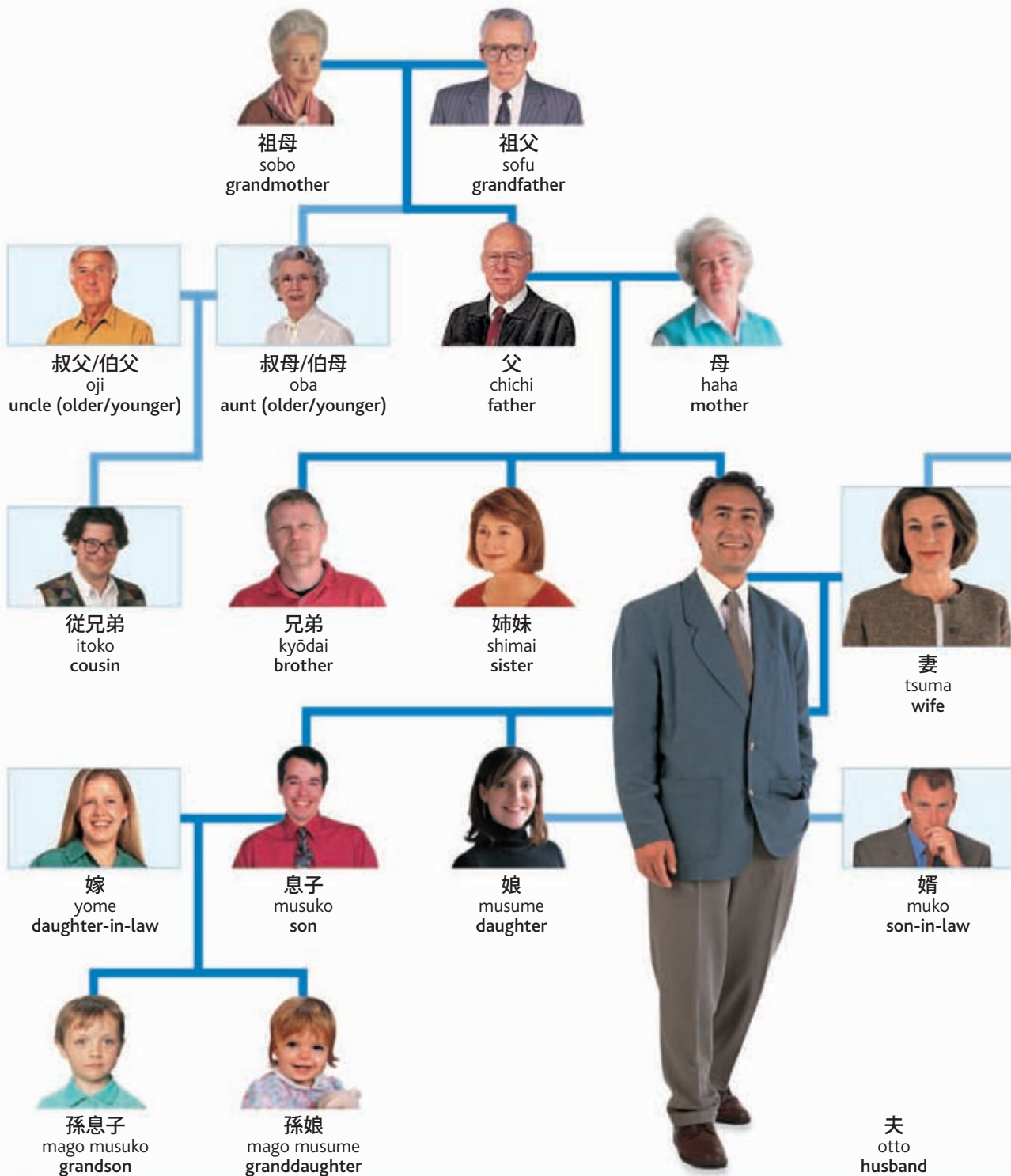

関連用語 kanrenyōgo • vocabulary

親類 shinrui relatives	両親 ryōshin parents	孫 mago grandchildren	継母 mama haha stepmother	継息子 mama musuko stepson	配偶者 haigūsha partner
世代 sedai generation	子供 kodomo children	祖父母 sofubo grandparents	継父 mama chichi stepfather	継娘 mama musume stepdaughter	双子 futago twins



義母
gibo
mother-in-law

義父
gifu
father-in-law



義兄弟
gikyōdai
brother-in-law

義理の姉妹
giri no shimai
sister-in-law



姪
mei
niece

甥
oi
nephew

さん
san
Mrs.

敬称 keishō • titles

ちゃん
chan
Miss/Master

さん
san
Mr.



成長段階 seichō dankai
• stages



乳児
nyūji
baby



子供
kodomo
child



男の子
otoko no ko
boy



女の子
onna no ko
girl



ティーンエイジャー
tin'ejā
teenager



大人
otona
adult



男性
dansei
man



女性
josei
woman

人間関係 ningen kankei • relationships

マネージャー
manējā
manager

アシスタント
ashisutanto
assistant

ビジネス・パートナー
bijinesu pātonā
business partner

雇用主
koyōnushi
employer

従業員
jūgyōin
employee

同僚
dōryō
colleague



オフィス ofisu | office



隣人
rinjin
neighbor



友人
yūjin
friend



知人
chijin
acquaintance



ペンパル
penparu
pen pal

ボーイフレンド
bōifurendo
boyfriend



カップル kappuru | couple

ガールフレンド
gārufurendo
girlfriend

婚約者
kon'yakusha
fiancé



婚約者
kon'yakusha
fiancée

婚約中のカップル kon'yaku-chū no kappuru | engaged couple

感情 kanjō • emotions



微笑
bishō
smile

嬉しい
ureshī
happy



悲しい
kanashī
sad



興奮する
kōfun suru
excited



飽きる
akiru
bored



驚く
odoroku
surprised



怖がる
kowagaru
scared



しか目面
shikame-zura
frown

怒る
okoru
angry



混乱する
konran suru
confused



心配する
shimpai suru
worried



不安
fuan
nervous



誇る
hokoru
proud



自信
jishin
confident



恥ずかしい
hazukashī
embarrassed



はにかむ
hanikamu
shy

関連用語 kanrenyōgo • vocabulary

狼狽する
rōbai suru
upset

笑う
warau
laugh (v)

溜息をつく
tameiki o tsuku
sigh (v)

怒鳴る
donaru
shout (v)

衝撃を受ける
shōgeki o ukeru
shocked

泣く
naku
cry (v)

気絶する
kizetsu suru
faint (v)

欠伸する
akubi suru
yawn (v)

人生 jinsei • life events



生まれる
umareru
be born (v)



入学する
nyūgaku suru
start school (v)



友達になる
tomodachi ni naru
make friends (v)



卒業する
sotsugyō suru
graduate (v)



就職する
shūshoku suru
get a job (v)



恋愛する
ren'ai suru
fall in love (v)



結婚する
kekkon suru
get married (v)



出産する
shussan suru
have a baby (v)



結婚式 kekkonshiki | wedding



離婚
rikon
divorce



葬式
sōshiki
funeral

関連用語 kanrenyōgo • vocabulary

洗礼
senrei
christening

遺言状を書く
yuigonjō o kaku
make a will (v)

記念日
kinembi
anniversary

出生証明書
shusseishi shōmeisho
birth certificate

移民する
imin suru
emigrate (v)

結婚披露宴
kekkon hirōen
wedding reception

退職する
taishoku suru
retire (v)

ハネムーン
hanemūn
honeymoon

死ぬ
shinu
die (v)

バルミツバー
barumitsubā
bar mitzvah

お祝い oiwai • celebrations

誕生日パーティー
tanjō pātī
birthday party



誕生日
tanjōbi
birthday

カード
kādo
card



プレゼント
purezento
present



クリスマス
kurisumasu
Christmas

祭り matsuri
• festivals



逾越祭
sugikoshimatsuri
Passover



正月
shōgatsu
New Year



カーニバル
kānibaru
carnival

行列
gyōretsu
procession



ラマダーン
ramadān
Ramadan

リボン
ribon
ribbon



感謝祭
kanshasai
Thanksgiving



復活祭
fukkatsusai
Easter



ハロウィーン
harowīn
Halloween



ディワリー
diwārī
Diwali





外觀 gaikan
appearance

子供服 kodomo fuku • children's clothing

赤ちゃん akachan • baby



肌着
hadagi
bodysuit

ベビーグロー
bebīgurō
onesie

スナップ
sunappu
snap



スリープスーツ
surīpusūtsu
sleeper



スノースーツ
sunōsūtsu
snowsuit



ロンパース
rompāsu
romper



よだれ掛け
yodarekake
bib



ミトン
miton
mittens



ブーツィ
būti
booties



おむつ
omutsu
terrycloth diaper



紙おむつ
kami omutsu
disposable diaper



おむつカバー
omutsu kabā
plastic pants

幼児 yōji • toddler



日よけ帽
hiyokebō
sun hat



エプロン
epuron
apron



半ズボン
hanzubon
shorts

オーバーオール
ōbāōru
overalls



Tシャツ
tīshatsu
t-shirt



スカート
sukāto
skirt

子供 kodomo • child



ワンピース
wampīsu
dress

フード
fūdo
hood

ジーパン
jīpan
jeans

サンダル
sandanu
sandals

夏
natsu
summer



レインコート
reinkōto
raincoat



リュックサック
ryukkusakku
backpack

トグルボタン
togurubotan
toggle

秋
aki
fall



ダッフルコート
daffurukōto
duffel coat



マフラー
mafurā
scarf

アノラック
anorakku
parka

長靴
nagagutsu
rain boots

冬
fuyu
winter



ナイトガウン
naitogaun
bathrobe

ロゴ
rogo
logo

スニーカー
sunikā
athletic shoes

ネグリジェ
negurije
nightgown

スリッパ
surippa
slippers

寝間着
nemaki
nightwear



サッカー着
sakkā-gi
soccer uniform



トラックスーツ
torakkusūtsu
running suit



レギンス
reginsu
leggings

関連用語 kanrenyōgo • vocabulary

天然繊維
tennen sen'i
natural fiber

合成繊維
gōsei sen'i
synthetic fiber

洗濯機で洗えますか。
sentakki de araemasuka?
Is it machine washable?

2歳児に着れますか。
nisai-ji ni kiremasuka?
Will this fit a two-year-old?

男性服 dansei fuku • men's clothing



襟
eri
collar

ネクタイ
nekutai
tie

ベルト
beruto
belt

ラペル
raperu
lapel

ボタンホール
botanhōru
buttonhole

袖口
sodeguchi
cuff

ポケット
poketto
pocket

上着
uwagi
jacket

ボタン
botan
button

ズボン
zubon
trousers

スーツ
sūtsu
business suit

コート
kōto
coat

裏地
uraji
lining

革靴
kawagutsu
leather
shoes

関連用語 kanrenyōgo • vocabulary

ワイシャツ
waishatsu
shirt

ナイトガウン
naitogaun
bathrobe

トラックスーツ
torakkusūtsu
running suit

長い
nagai
long

カーディガン
kādigan
cardigan

下着
shitagi
underwear

レインコート
reinkōto
raincoat

短い
mijikai
short

もっと大きい／小さいサイズはありますか。
motto ōki/chīsai saizu wa arimasuka?
Do you have this in a larger/smaller size?

試着できますか。
shichaku dekimasuka?
May I try this on?



ブレザー
burezā
blazer



スポーツジャケット
supōtsu jaketto
sports jacket



ベスト
besuto
vest

Vネック
buinekku
v-neck

丸首
marukubi
round neck

Tシャツ
tīshatsu
t-shirt

スエットパンツ
suettopantsu
sweatpants



アノラック
anorakku
parka



トレーナー
torēnā
sweatshirt



ウインドブレーカー
uindoburēkā
windbreaker



セーター
sētā
sweater



パジャマ
pajama
pajamas



肌着
hadagi
undershirt

カジュアルウェア
kajuaruwa
casual wear



短パン
tampan
shorts



ブリーフ
burifu
briefs



ボクサーショーツ
bokusāshōtsu
boxer shorts



靴下
kutsushita
socks

女性服 josei fuku • women's clothing



ランジェリー ranjerī • lingerie



ナイトガウン
naitogaun
negligée



スリッパ
surippu
slip

ストラップ
sutorappu
strap



キャミソール
kyamisōru
bra camisole



バスク
basuku
bustier

ガーター
gātā
suspenders



ストッキング
sutokkingu
stockings



パンスト
pansuto
pantyhose

ベスト
besuto
vest



パンティ
panti
panties



ブラジャー
burajā
bra



ネグリジェ
negurije
nightgown

結婚式 kekkonshiki • wedding

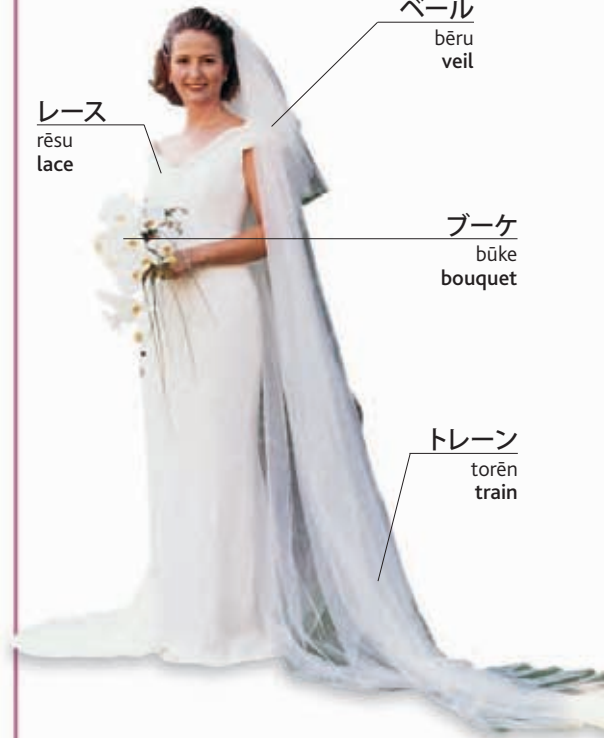

ベール
bēru
veil

レース
rēsu
lace

ブーケ
būke
bouquet

トレーン
torēn
train

ウェディングドレス
wedingudoresu
wedding dress

関連用語 kanrenyōgo
• vocabulary

コルセット
korusetto
corset

テーラード
tērādo
tailored

ガーター
gātā
garter

ホールターネック
hōrutā nekku
halter neck

ショルダーパッド
shorudāpaddo
shoulder pad

ワイヤーカップ
waiyā kappu
underwired

ウエストバンド
uesutobando
waistband

スポーツ用ブラジャー
supōtsu-yō burajā
sports bra

着物
kimono
kimono

装身具 sōshingu • accessories



野球帽
yakyūbō
cap



帽子
bōshi
hat



スカーフ
sukāfu
scarf



ベルト
beruto
belt



ハンカチ
hankachi
handkerchief



蝶ネクタイ
chōnekutai
bow tie



ネクタイピン
nekutai-pin
tie clip



手袋
tebukuro
gloves



柄
e
handle

先端
sentan
tip

傘
kasa
umbrella

アクセサリ akusesarī • jewellery



ペンダント
pendanto
pendant



ブローチ
burōchi
brooch



カフスボタン
kafusubotan
cufflink

リンク
rinku
link

クラスプ
kurasupu
clasp

イヤリング
iyaringu
earring

指輪
yubiwa
ring

宝石
hōseki
stone

ネックレス
nekkuresu
necklace

腕時計
udedokei
watch

真珠の首飾り
shinju no kubikazari
string of pearls



ブレスレット
buresuretto
bracelet



チェーン
chēn
chain



宝石箱 hōseki-bako | jewelry box

バッグ baggu • bags



札入れ
satsuire
wallet



財布
saifu
change purse



ショルダーバッグ
shorudābaggu
shoulder bag

留め金
tomegane
fastening

ストラップ
sutorappu
shoulder strap

取っ手
totte
handles



旅行鞆
ryokōkaban
duffle bag



ブリーフケース
burifukēsu
briefcase



ハンドバッグ
handobaggu
handbag



リュックサック
ryukkusakku
backpack

靴 kutsu • shoes

靴紐穴
kutsuhimo ana
eyelet

靴紐
kutsuhimo
lace

ベロ
bero
tongue

靴底
kutsuzoko
sole

踵
kakato
heel



編上靴
amiagegutsu
lace-up



ハイキングブーツ
haikingu bŭtsu
hiking boot



スニーカー
sunikā
athletic shoe



革靴
kawagutsu
leather shoe



ゴム草履
gomuzōri
flip-flop



ハイヒール
haihiru
high-heeled shoe



プラットフォームシューズ
purattofōmu shūzu
platform shoe



サンダル
sandaru
sandal



スリッポン
surippon
slip-on



短靴
tangutsu
wingtip

髪 kami • hair



櫛
kushi
comb

櫛で梳く
kushi de suku
comb (v)



ヘアブラシ
heaburashi
brush

ブラシをかける
burashi o kakeru | brush (v)



濯ぐ
yusugu
rinse (v)



髪結い
kamiyui
hairdresser

シャンプー台
shampū dai
sink

客
kyaku
client

洗う arau | wash (v)



ガウン
gaun
cape

カットする
katto suru
cut (v)



ブローする
burō suru
blow dry (v)



セットする
setto suru
set (v)

備品 bihin • accessories



ヘアドライヤー
headoraiyā
hairdryer



シャンプー
shampū
shampoo



コンディショナー
kondishonā
conditioner



ジェル
jeru
gel



ヘアスプレー
heasupurē
hairspray



鋏
hasami
scissors



ヘアバンド
heabando
headband



カーラー
kāra
curler



ヘアピン
heapin
bobby pin



カールアイロン
kāru airon
curling iron

髪型 kamigata • styles



ポニーテール
ponitēru
ponytail

リボン
ribon
ribbon



三つ編み
mitsuami
braid



フレンチブリーツ
furenchi purītsu
french twist



お団子
odango
bun



お下げ
osage
pigtails



ボブ
bobu
bob



坊ちゃん刈り
botchangari
crop



カール
kāru
curly



パーマ
pāma
perm



ストレート
sutorēto
straight



ハイライト
hairaito
highlights

毛根
mōkon
roots



はげ頭
hageatama
bald



髪
katsura
wig

関連用語 kanrenyōgo • vocabulary

整髪する
seihatsu suru
trim (v)

脂質
abura shitsu
greasy

ストレートにする
sutorēto ni suru
straighten (v)

乾燥質
kansō shitsu
dry

床屋
tokoya
barber

普通
futsū
normal

フケ
fuke
dandruff

頭皮
tōhi
scalp

枝毛
edage
split ends

ヘアタイ
heatai
hair tie

ヘアカラー hea karā • colors



ブロンド
burondo
blonde



ブルネット
burunetto
brunette



赤茶色
akachairo
auburn



赤毛
akage
ginger



黒髪
kurokami
black



グレー
gurē
gray



ホワイト
howaito
white



染髪
sempatsu
dyed

美容 biyō • beauty



ヘアカラー
heakarā
hair dye

アイシャドー
aishadō
eye shadow

マスカラ
masukara
mascara

アイライナー
airainā
eyeliner

頬紅
hōbeni
blusher

ファンデーション
fandeshon
foundation

口紅
kuchibeni
lipstick

メーキャップ mēkyappu • makeup



アイブロウペンシル
aiburow penshiru
eyebrow pencil



アイブロウブラシ
aiburow burashi
eyebrow brush



毛抜き
kenuki
tweezers



リップグロス
rippu gurosu
lip gloss



リップブラシ
rippu burashi
lip brush



リップライナー
rippu rainā
lip liner



ブラシ
burashi
brush



コンシーラー
konshirā
concealer

コンパクトミラー
kompakuto mirā
mirror

白粉
oshiroi
face powder

パフ
pafu
powder puff



コンパクト kompakuto | compact

エステ esute • beauty treatments

フェースパック
fēsu pakuu
facial mask



サンベッド
sambeddo
sunbed



フェーシャル
fēsharu
facial



角質除去する
kakushitsu jokyo suru
exfoliate (v)



ワックス
wakkusu
wax



ペディキュア
pedikyua
pedicure



マニキュア manikyua • manicure

除光液
jokō eki
nail varnish remover



爪やすり
tsume yasuri
nail file



マニキュア
manikyua
nail varnish



爪切り
tsumekiri
nail scissors



爪切り
tsumekiri
nail clippers



化粧品 keshōhin • toiletries

クレンザー
kurenzā
cleanser



化粧水
keshōsui
toner



乳液
nyūeki
moisturizer



セルフタニング・クリーム
serufu tanningu kurīmu
self-tanning cream



香水
kōsui
perfume



オードトワレ
ōdotoware
eau de toilette



関連用語 kanrenyōgo • vocabulary

肌の色 hada no iro complexion	脂肌 abura hada oily	日焼け hiyake tan
色白 irojiro fair	敏感肌 binkan hada sensitive	入れ墨 irezumi tattoo
色黒 iroguro dark	低刺激性 tei-shigeki sei hypoallergenic	皺取り shiwa tori anti-wrinkle
乾燥肌 kansō hada dry	色合い iroai shade	コットンボール kotton bōru cotton balls





健康 kenkō
health



病気 byōki • illness



熱 netsu | fever



頭痛 zutsū
headache



鼻血 hanaji
nosebleed



咳 seki
cough



くしゃみ kushami
sneeze



風邪 kaze
cold



インフルエンザ infuruenza
flu



吸入器 kyūnyūki
inhaler

喘息 zensoku
asthma



腹痛 fukutsū
cramps



吐き気 hakike
nausea



水痘 suitō
chickenpox



発疹 hosshin
rash

関連用語 kanrenyōgo • vocabulary

脳卒中
nōsotchū
stroke

糖尿病
tōnyōbyō
diabetes

アトピー性皮膚炎
atopisei hifuen
eczema

悪寒
okan
chill

吐く
haku
vomit (v)

下痢
geri
diarrhea

血圧
ketsuatsu
blood pressure

アレルギー
arerugi
allergy

感染
kansen
infection

胃痛
itsu
stomach ache

癲癇
tenkan
epilepsy

麻疹
hashika
measles

心臓発作
shinzōhossa
heart attack

花粉症
kafunshō
hayfever

ウイルス
uirusu
virus

失神する
shisshin suru
faint (v)

片頭痛
henzutsū
migraine

おたふく風邪
otafukukaze
mumps

医者 isha • doctor

診察 shinsatsu • consultation



医者
isha
doctor

レントゲン・ビューアー
rentogen byuā
x-ray viewer

処方箋
shohōsen
prescription

患者
kanja
patient

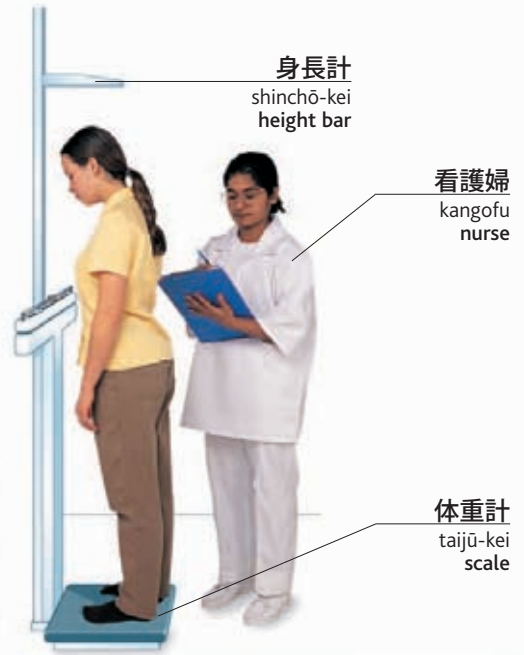

身長計
shinchō-kei
height bar

看護婦
kangofu
nurse

体重計
taiju-kei
scale

血圧計

ketsuatsukei
blood pressure gauge

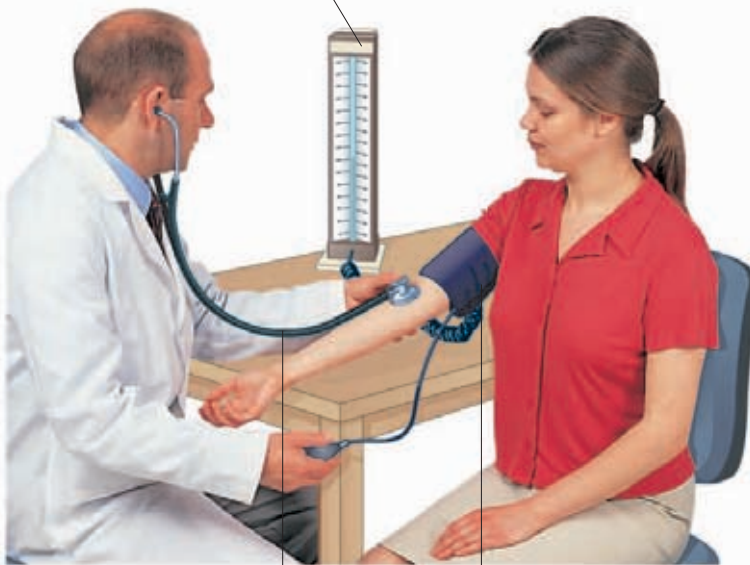

聴診器
chōshinki
stethoscope

加圧帯
ka'atsutai
cuff

関連用語 kanrenyōgo

• vocabulary

予約
yoyaku
appointment

予防接種
yobō-sesshu
inoculation

診療室
shinryō-shitsu
doctor's office

体温計
taionkei
thermometer

待合室
machiai-shitsu
waiting room

診察
shinsatsu
medical
examination

医者に行かなければなりません。
isha ni ikanakereba narimasen.
I need to see a doctor.

ここが痛い。
koko ga itai.
It hurts here.

怪我 kega • injury



捻挫 nenza | sprain

三角布
sankakufu
sling



ギブス
gibusu
neck brace

骨折
kossetsu
fracture



鞭打ち症
muchiuichishō
whiplash



切り傷
kirikizu
cut



擦り傷
surikizu
abrasion



痣
aza
bruise



刺
toge
splinter



日焼け
hiyake
sunburn



火傷
yakedo
burn



かみ傷
kamikizu
bite



虫刺され
mushi-sasare
sting

関連用語 kanrenyōgo • vocabulary

事故
jiko
accident

出血
shukketsu
hemorrhage

中毒
chūdoku
poisoning

大丈夫でしょうか。
daijōbu deshōka?
Will he/she be all right?

緊急事態
kinkyūjitai
emergency

水ぶくれ
mizbukure
blister

感電
kanden
electric shock

どこが痛みますか。
doko ga itamimasuka?
Where does it hurt?

傷
kizu
wound

脳しんとう
nōshintō
concussion

頭部外傷
tōbu gaishō
head injury

救急車を呼んでください。
kyūkyūsha o yonde kudasai.
Please call an ambulance.

応急手当 ōkyū teate • first aid

軟膏
nankō
ointment

バンドエード
bandoēdo
adhesive bandage

安全ピン
anzempin
safety pin

包帯
hōtai
bandage

痛み止め
itami-dome
analgesics



消毒ワイプ
shōdoku waipu
antiseptic wipe

ピンセット
pinsetto
tweezers

鉗
hasami
scissors

消毒液
shōdoku eki
antiseptic

救急箱 kyūkyūbako | first aid box

ガーゼ
gāze
gauze



手当
teate
dressing



副木 fukuboku | splint



絆創膏
bansōkō
adhesive tape



救急蘇生
kyūkyū sosei
resuscitation

関連用語 kanrenyōgo • vocabulary

ショック
shokku
shock

脈拍
myakuhaku
pulse

窒息する
chissoku
suru
choke (v)

助けてください。
tasukete kudasai.
Please help.

意識不明
ishikifumei
unconscious

呼吸
kokyū
breathing

殺菌
sakkīn
sterile

応急手当のやり方を知っていますか。
ōkyū teate no yarikata o shitte imasuka?
Do you know first aid?

病院 byōin • hospital

外科医
geka-i
surgeon

看護婦
kangofu
nurse

手術室
shujutsu-shitsu
operating room

車輪付き担架
sharin-tsuki tanka
gurney

呼び出しボタン
yobidashi botan
call button

緊急治療室
kinkyū chiryō-shitsu
emergency room

病室
byōshitsu
hospital room

車椅子
kurumaisu
wheelchair

カルテ
karute
chart

麻酔士
masui-shi
anesthesiologist

血液検査
ketsueki kensa
blood test

注射
chūsha
injection

レントゲン
rentogen
x-ray

スキャン
sukyan
scan

関連用語 kanrenyōgo • vocabulary

手術
shujutsu
operation

退院
tai'in
discharged

面会時間
menkai jikan
visiting hours

小児病棟
shōni byōtō
children's ward

集中治療室
shūchū chiryō-shitsu
intensive care unit

入院
nyūin
admitted

診療所
shinryōjo
clinic

産科病棟
sanka byōtō
maternity ward

個室
koshitsu
private room

外来患者
gairaikanja
outpatient

医療部門 iryō bumon • departments



耳鼻咽喉科
jibi'inkō-ka
ears, nose, and throat (ENT)



心臓病科
shinzōbyō-ka
cardiology



整形外科
seikeige-ka
orthopedics



婦人科
fujin-ka
gynecology



理学療法科
rigakuryōhō-ka
physical therapy



皮膚科
hifu-ka
dermatology



小児科
shōni-ka
pediatrics



放射線科
hōshasen-ka
radiology



外科
geka
surgery



産科
sanka
maternity



精神科
seishin-ka
psychiatry



眼科
ganka
ophthalmology

関連用語 kanrenyōgo • vocabulary

神経科
shinkei-ka
neurology

泌尿器科
hinyōki-ka
urology

内分泌科
naibumpi-ka
endocrinology

病理科
byōri-ka
pathology

結果
kekka
result

癌科
gan-ka
oncology

形成外科
keisei-geka
plastic surgery

照会
shōkai
referral

検査
kensa
test

専門医
senmon'i
specialist

歯医者 haisha • dentist

歯 ha • tooth

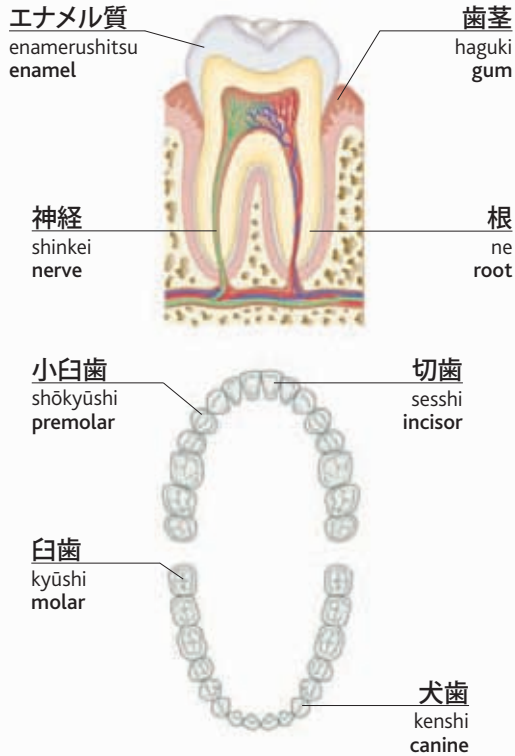

歯科検診 shika kenshin • checkup



関連用語 kanrenyōgo • vocabulary

歯痛 haita toothache

ドリル doriru drill

歯垢 shikō plaque

デンタルフロス dentaru furosu dental floss

虫歯 mushiba decay

抜歯 basshi extraction

詰め物 tsumemono filling

歯冠 shikan crown



デンタルフロスで掃除する dentaru furosu de sōji suru floss (v)



歯磨きする hamigaki suru brush (v)



歯列矯正ブリッジ shiretsu kyōsei burijji braces



歯科レントゲン shika rentogen dental x-ray



レントゲン写真 rentogen shashin x-ray film



入れ歯 ireba dentures

眼鏡店 megane-ten • optician



視力検査 shiryoku kensa | eye test

ケース
kēsu
case



眼鏡
megane
glasses

レンズ
renzu
lens



サングラス
sangurasu
sunglasses

フレーム
furēmu
frame

洗浄液
senjō eki
cleaning fluid



消毒液
shōdoku eki
disinfectant solution

レンズケース
renzu kēsu
lens case



コンタクトレンズ kontakutorenu | contact lenses

目 me • eye

眉毛
mayuge
eyebrow

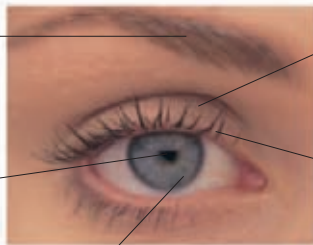

瞼
mabuta
eyelid

瞳孔
dōkō
pupil

まつげ
matsuge
eyelash

虹彩
kōsai
iris

網膜
mōmaku
retina

水晶体
suishōtai
lens

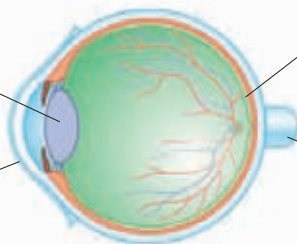

視神経
shishinkei
optic nerve

角膜
kakumaku
cornea

関連用語 kanrenyōgo • vocabulary

視力
shiryoku
vision

乱視
ranshi
astigmatism

ジオプター
jioputā
diopter

遠視
enshi
farsightedness

涙
namida
tear

近視
kinshi
nearsightedness

白内障
hakunaishō
cataract

遠近両用
enkin ryōyō
bifocal

妊娠 ninshin • pregnancy



看護婦
kangofu
nurse

妊娠テスト
ninshin tesuto
pregnancy test

スキャン
sukyan
scan

超音波 (検査) chōmpa (kensa) | ultrasound (test)

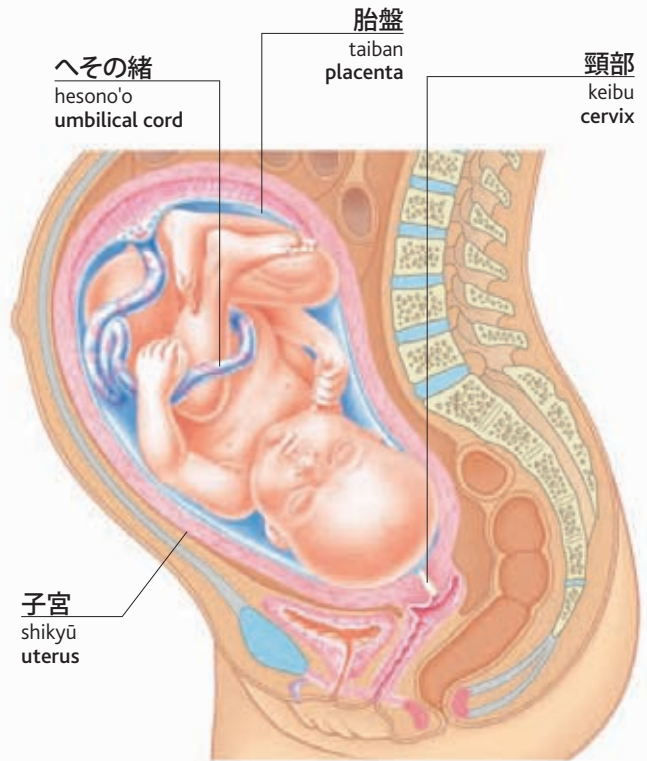

へその緒
hesono'o
umbilical cord

胎盤
taiban
placenta

頸部
keibu
cervix

子宮
shikyū
uterus

胎児 taiji | fetus

関連用語 kanrenyōgo • vocabulary

排卵
hairan
ovulation

出産前
shussan mae
prenatal

陣痛
jintsū
contraction

子宮頸部拡張
shikyū keibu kakuchō
dilation

分娩
bumben
delivery

逆子
sakago
breech

受胎
jutai
conception

胚
hai
embryo

破水する
hasui suru
break waters (v)

硬膜外麻酔
kōmaku-gai masui
epidural

誕生
tanjō
birth

未熟児
mijukuji
premature

妊娠
ninshin
pregnant

子宮
shikyū
uterus

羊水
yōsui
amniotic fluid

会陰切開
kai'in sekkai
episiotomy

流産
ryūzan
miscarriage

婦人科医
fujinka-i
gynecologist

妊娠している
ninshin shiteiru
expectant

三半期
sanhanki
trimester

羊水穿刺
yōsui senshi
amniocentesis

帝王切開
tei'ō sekkai
cesarean section

縫合
hōgō
stitches

産科医
sanka-i
obstetrician

出産 shussan • childbirth

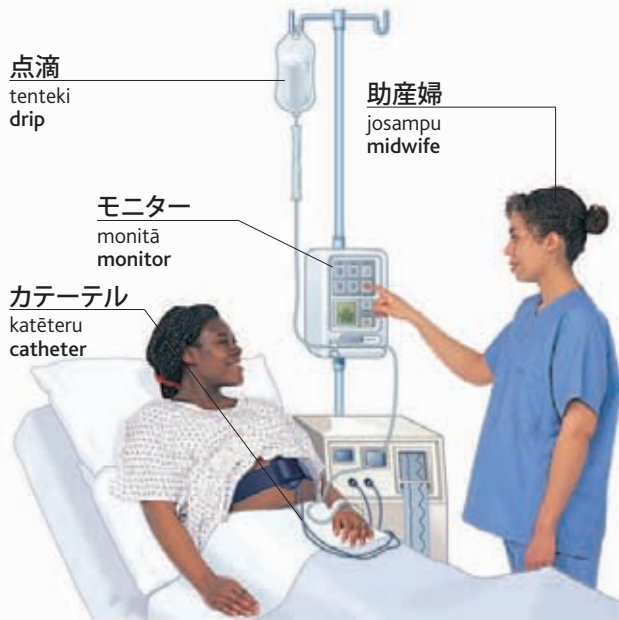

点滴
tenteki
drip

助産婦
josampu
midwife

モニター
monitā
monitor

カテーテル
katēteru
catheter

陣痛促進する jintsū sokushin suru | induce labor (v)



保育器 hoikuki | incubator



赤ちゃん用体重計
akachan-yō taijūkei
scale

出生時体重 shusseiji taijū | birth weight

鉗子
kanshi
forceps

真空カップ
shinkū kappu
suction cup

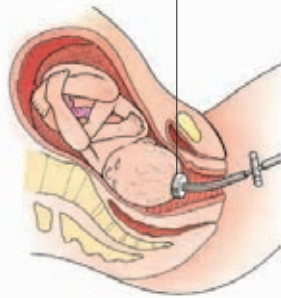
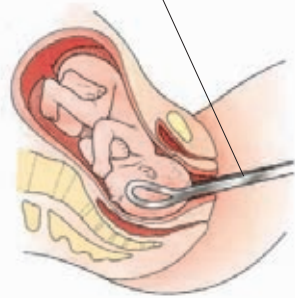

介助分娩
kaijo bumben
assisted delivery

識別バンド
shikibetsu bando
identification tag



新生児 shinseiji | newborn baby

授乳 junyū • nursing



搾乳機
sakunyū-ki
breast pump



授乳ブラジャー
junyū burajā
nursing bra



授乳する
junyū suru
breastfeed (v)



パッド
paddo
pads

代替療法 daitai ryōhō • alternative therapy



ヨガ yoga | yoga

マット
matto
mat

先生
sensei
teacher



マッサージ
massāji
massage



指圧
shiatsu
shiatsu



瞑想
meisō
meditation



カイロプラクティック
kairopurakutikku
chiropractic



整骨療法
seikotsu ryōhō
osteopathy



リフレクソロジー
rifurekusorojī
reflexology

カウンセラー
kaunserā
counselor



グループ療法
gurūpu ryōhō
group therapy



レイキ療法
reiki ryōhō
reiki



鍼療法
hari ryōhō
acupuncture



アユルヴェーダ
ayurveda
ayurveda



催眠療法
saimin ryōhō
hypnoterapy

精油
seiyu
essential oils



本草学
honsō-gaku
herbalism



アロマセラピー
aromaterapī
aromatherapy



ホメオパシー
homeopashī
homeopathy



指圧療法
shiatsu ryōhō
acupressure therapy

療法士
ryōhōshi
therapist



心理療法
shinri ryōhō
psychotherapy

関連用語 kanrenyōgo • vocabulary

サプリメント
sapurimento
supplement

自然療法
shizen ryōhō
naturopathy

リラクゼーション
rirakusēshon
relaxation

薬草
yakusō
herb

水治療法
suichi ryōhō
hydrotherapy

風水
fūsui
feng shui

ストレス
sutoresu
stress

水晶療法
suishō ryōhō
crystal healing



A close-up, abstract photograph of a hand holding a green pen. The hand is in the foreground, and the pen is in the background. The image is dominated by vibrant colors: a bright red hand, a green pen, and a yellow background. A white horizontal band runs across the middle of the image, containing the text '家庭 katei home'.

家庭 katei
home

住宅 jūtaku • house

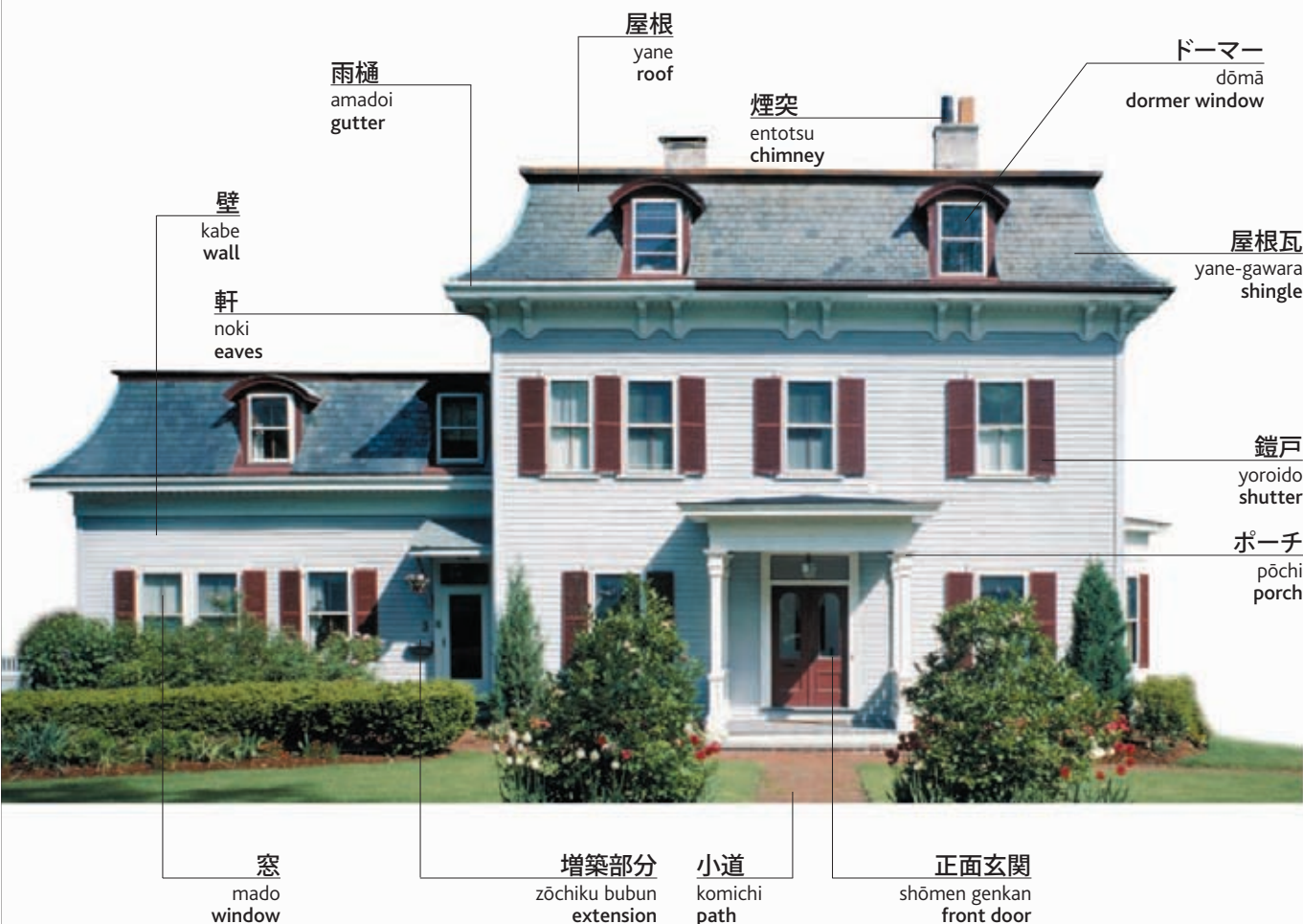

関連用語 kanrenyōgo • vocabulary

一戸建て
ikkodate
detached

借家人
shakuyanin
tenant

車庫
shako
garage

郵便受け
yūbin-uke
letter slot

防犯ベル
bōhan beru
burglar alarm

貸す
kasu
rent (v)

セミデタッチ
semidetatchi
semidetached

平屋
hiraya
bungalow

屋根裏部屋
yaneura-beya
attic

玄関灯
genkan-tō
porch light

中庭
nakaniwa
courtyard

家賃
yachin
rent

タウンハウス
taunhausu
townhouse

地下室
chikashitsu
basement

部屋
heya
room

大家
ōya
landlord

床
yuka
floor

テラス
terasu
terraced

入口 iriguchi • entrance



手摺
tesuri
hand rail

階段
kaidan
staircase

踊り場
odoriba
landing

階段の手摺
kaidan no tesuri
banister

玄関
genkan
hallway



呼び鈴
yobirin
doorbell



玄関マット
genkan matto
doormat



ドアノッカー
doanokkā
door knocker



ドアチェーン
doachēn
door chain

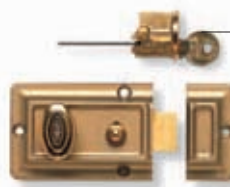

錠
jō
lock



門
kannuki
bolt

鍵
kagi
key

マンション manshon
• apartment



ベランダ
beranda
balcony

マンション棟
manshon-tō
apartment building



インターホン
intāhon
intercom



エレベーター
erebetā
elevator

住宅内設備 jūtaku-nai setsubi • utilities



ラジエーター
rajiētā
radiator



ヒーター
hītā
space heater



羽
hane
blade

扇風機
sempūki
fan



ファンヒーター
fanhītā
portable heater

電気設備 denki setsubi • electricity



フィラメント
firamento
filament

接地ピン
setchi pin
ground prong

バヨネット式
bayonetto-shiki
thread

電球 denkyū | light bulb



プラグ puragu | plug

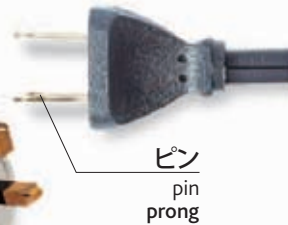

ピン
pin
prong

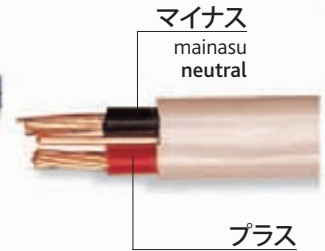

マイナス
mainasu
neutral

プラス
purasu
live

電線 densen | wires

関連用語 kanrenyōgo • vocabulary

電圧
den'atsu
voltage

ヒューズ
hyūzu
fuse

コンセント
konsento
outlet

直流連流
chokuryū denryū
direct current (DC)

停電
teiden
power outage

アンペア
ampea
amp

ヒューズボックス
hyūzu bokkusu
fuse box

スイッチ
suitchi
switch

変圧器
hen'atsuki
transformer

電源
dengen
domestic supply

電力
denryoku
power

発電機
hatsudenki
generator

交流電流
kōryū denryū
alternating current (AC)

電力量計
denryokuryō-kei
electricity meter

配管設備 haikan setsubi • plumbing

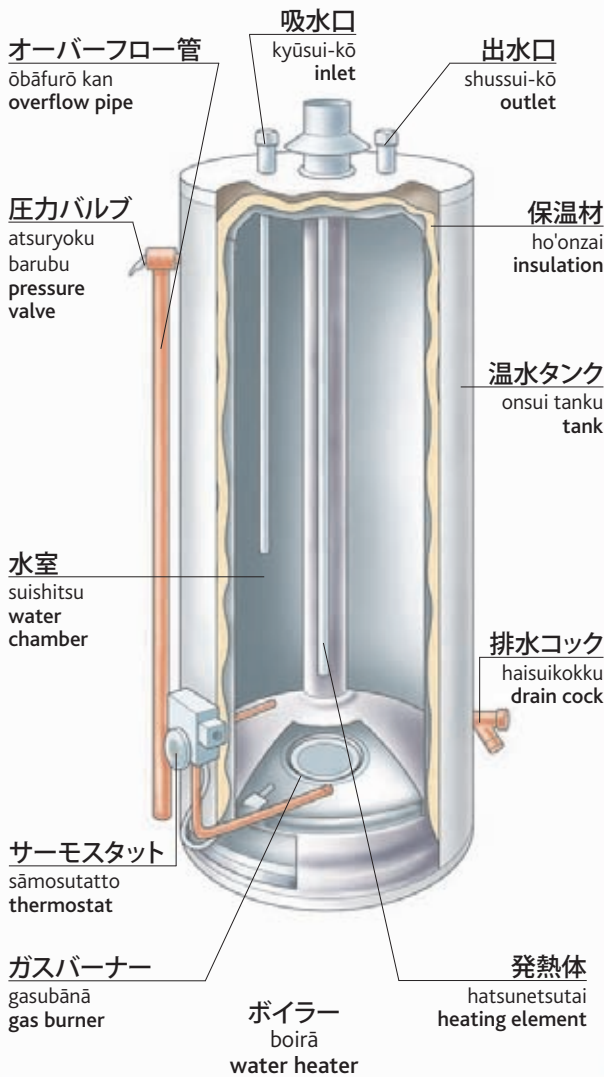

流し台 nagashidai • sink

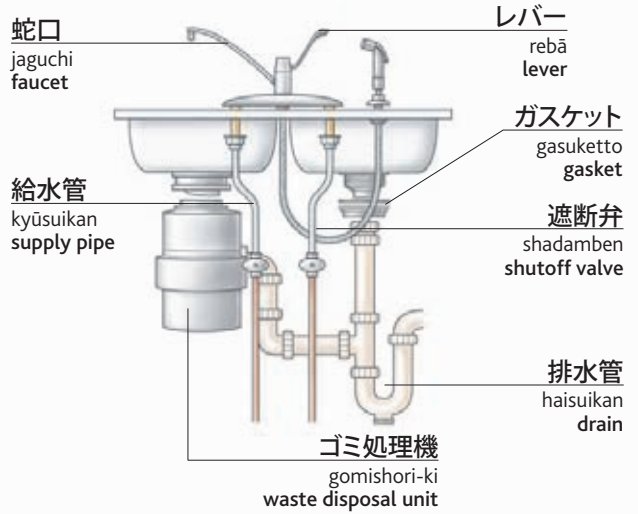

トイレ toire • toilet

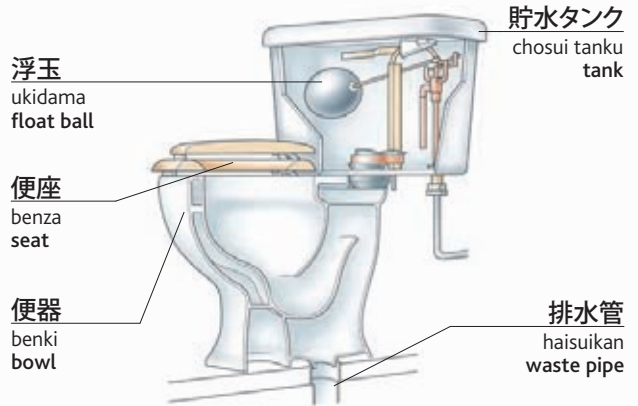

ゴミ処理 gomishori • waste disposal

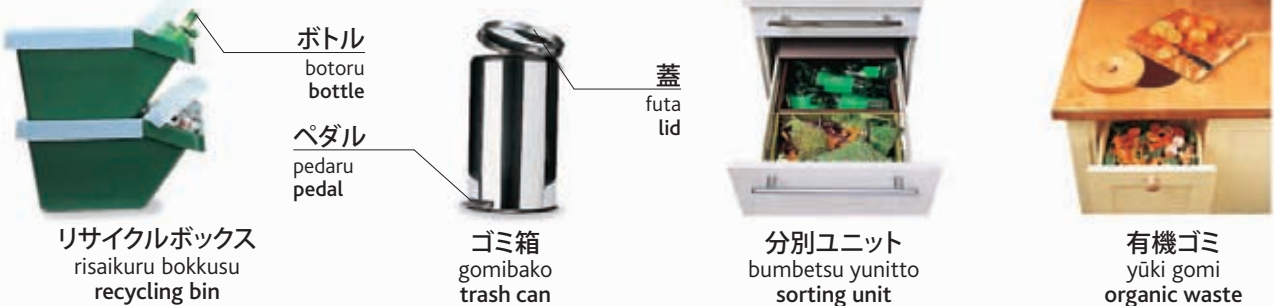

居間 ima • living room



絵
e
painting

額縁
gakubuchi
frame

ランプ
rampu
lamp

壁面照明
hekimen shōmei
wall light

時計
tokei
clock

天井
tenjō
ceiling

食器棚
shokkidana
cabinet

ソファ
sofa
sofa

クッション
kushshon
cushion

コーヒーテーブル
kōhī tēburu
coffee table

床
yuka
floor

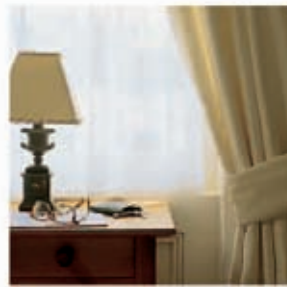

カーテン
kāten
curtain



メッシュカーテン
messhu kāten
sheer curtain



ベネシャンブラインド
beneshan buraindo
venetian blind



ロールスクリーン
rōru sukurīn
window shade

モールディング
mōrudingu
molding

アームチェア
āmucnea
armchair



書斎 shosai | study

ダイニングルーム dainingu rūmu • dining room



関連用語 kanrenyōgo • vocabulary

給仕する
kyūji suru
serve (v)

朝食
chōshoku
breakfast

満腹
mampuku
full

箸
hashi
chopsticks

おかわりできますか。
okawari dekimasuka?
May I have some more, please?

食べる
taberu
eat (v)

昼食
chūshoku
lunch

一人分
hitoribun
one portion

ご飯茶碗
gohan-jawan
rice bowl

もう結構です。
mō kekkō desu.
I've had enough, thank you.

空腹
kūfuku
hungry

夕食
yūshoku
dinner

食事
shokuji
meal

茶碗
chawan
(Japanese) teacup

美味しかったです。
oishikatta desu.
That was delicious.

テーブルクロス
tēburukurosu
tablecloth

ランチョンマット
ranchon matto
placemat

客
kyaku
guest

座布団
zabuton
(Japanese) floor cushion

食器類 shokki rui • dishes and utensils



マグカップ
magu kappu
mug



コーヒーカップ
kōhikappu
coffee cup



ティーカップ
tikappu
teacup

ティースプーン
tisupūn
teaspoon



皿
sara
plate



ボウル
bōru
bowl



カフェプレス
kafe puresu
cafetière



ティーポット
tipotto
teapot



水差し
mizusashi
pitcher



エッグカップ
eggu kappu
egg cup

ワイングラス
waingurasu
wine glass



タンブラー
tamburā
tumbler

コップ類
koppu rui
glassware

ナプキンリング
napukin ringu
napkin ring

小皿
kozara
side plate

大皿
ōzara
dinner plate

スープ皿
sūpuzara
soup bowl

スプーン
sūpusupūn
soup spoon



ナプキン
napukin
napkin

フォーク
fōku
fork

テーブル・セッティング
tēburu settingu
place setting

スプーン
supūn
spoon

ナイフ
naifu
knife

台所 daidokoro • kitchen



電気器具 denki kigu • appliances



製氷室
seihyōshitsu
icemaker

冷凍庫
reitōko
freezer



冷蔵庫
reizōko
refrigerator

棚
tana
shelf

野菜室
yasai-shitsu
crisper

冷凍冷蔵庫 reitōreizōko |refrigerator-freezer

関連用語 kanrenyōgo
• vocabulary

水切り台
mizukiridai
drainboard

ガスレンジ
gasurenji
burner

コンロ
konro
stovetop

ゴミ箱
gomibako
garbage can

冷凍する
reitō suru
freeze (v)

解凍する
kaitō suru
defrost (v)

蒸す
musu
steam (v)

炒める
itameru
sauté (v)

調理 chōri • cooking



皮を剥く
kawa o muku
peel (v)



切る
kiru
slice (v)



すり下ろす
suriorosu
grate (v)



注ぐ
sosogu
pour (v)



混ぜる
mazeru
mix (v)



泡立てる
awadateru
whisk (v)



茹でる
yuderu
boil (v)



揚げる
ageru
fry (v)



巻く
maku
roll (v)



かき回す
kakimawasu
stir (v)



煮込む
nikomu
simmer (v)



(沸騰前の温度で) 茹でる
(futtō mae no ondo de) yuderu
poach (v)



(オーブンで) 焼く
(ōbun de) yaku
bake (v)



ローストする
rōsuto suru
roast (v)



焼く
yaku
grill (v)

調理用具 chōri yōgu • kitchenware



まな板
manaïta
chopping block

ブレッドナイフ
bureddo naifu
bread knife



包丁
hōchō
kitchen knife



肉切り包丁
nikukiribōchō
cleaver



包丁研ぎ器
hōchō togi-ki
knife sharpener



肉たたき
nikutataki
meat tenderizer



串
kushi
skewer



卸し金
oroshigane
grater



すり粉木
surikogi
pestle



ポテトマッシャー
poteto masshā
masher



皮むき器
kawamuki-ki
peeler



リンゴの芯抜き器
ringo no shin nuki-ki
apple corer



缶切り
kankiri
can opener



栓抜き
sennuki
bottle opener



ガーリックプレス
gārikku puresu
garlic press



給仕用スプーン
kyūji-yō supūn
serving spoon



フライ返し
furaigaeshi
spatula



水切りざる
mizukiri zaru
colander



へら
hera
spatula



木製スプーン
mokusei supūn
wooden spoon



穴あきスプーン
ana'aki supūn
slotted spoon



おたま
otama
ladle



カービングフォーク
kābingu fōku
carving fork



アイスクリーム・スクープ
aisukurīmu sukūpu
scoop



泡立て器
awadaketi
whisk



ストレーナー
sutorēnā
strainer



ケーキ作り kēki-zukuri • baking cakes



寝室 shinshitsu • bedroom

洋服ダンス

yōfukudansu
wardrobe

ベッドサイドランプ

beddosaido rampu
bedside lamp

ヘッドボード

heddobōdo
headboard

ベッドサイドテーブル

beddosaido tēburu
bedside table

ダンス

tansu
chest of drawers



引き出し

hikidashi
drawer

ベッド

beddo
bed

マットレス

mattoresu
mattress

ベッドカバー

beddokabā
bedspread

枕

makura
pillow



湯たんぽ
yutampo
hot-water bottle



時計付きラジオ
tokei-tsuki rajio
clock radio



目覚まし時計
mezamashi-dokei
alarm clock



ティッシュの箱
tissu no hako
box of tissues



ハンガー
hangā
coat hanger

ベッド beddo • bed



鏡
kagami
mirror

化粧台
keshōdai
dressing table

床
yuka
floor



枕カバー
makurakabā
pillowcase

シーツ
shītsu
sheet

ベッドスカート
beddo sukāto
dust ruffle

羽布団
hanebuton
comforter

キルト
kiruto
quilt

毛布
mōfu
blanket



関連用語 kanrenyōgo • vocabulary

シングルベッド
shinguru beddo
twin bed

フットボード
futtobōdo
footboard

不眠症
fuminshō
insomnia

目覚める
mezameru
wake up (v)

目覚ましをかける
mezamashi o kakeru
set the alarm (v)

ダブルベッド
daburu beddo
full bed

スプリング
supuringu
spring

床につく
toko ni tsuku
go to bed (v)

起きる
okiru
get up (v)

鼾をかく
ibiki o kaku
snore (v)

布団
futon
comforter

カーペット
kāpetto
carpet

寝る
neru
go to sleep (v)

ベッドメイキングする
beddomēkingu suru
make the bed (v)

電気毛布
denkimōfu
electric blanket

浴室 yokushitsu • bathroom

タオル掛け
taorukake
towel rack

シャワードア
shawā doa
shower door

冷水タップ
reisui tappu
cold faucet

温水タップ
onsui tappu
hot faucet

シャワーヘッド
shawāheddo
shower head

流し台
nagashidai
sink

栓
sen
plug



浴槽
yokusō
bathtub



ビデ bide | bidet



シャワー
shawā
showerstall

排水口
haisuikō
drain

便座
benza
toilet seat

便器
benki
toilet

トイレブラシ
toire burashi
toilet brush

関連用語 kanrenyōgo • vocabulary

浴室用キャビネット
yokushitsu-yō kyabinetto
medicine cabinet

バスマット
basu matto
bath mat

トイレトペーパー
toiretto pēpā
toilet paper

シャワーカーテン
shawā kāten
shower curtain

シャワーを浴びる
shawā o abiru
take a shower (v)

風呂に入る
furo ni hairu
take a bath (v)

歯の手入れ ha no teire • dental hygiene



歯ブラシ
haburashi
toothbrush



歯磨き粉
hamigakiko
toothpaste



マウスウォッシュ
mausu wosshu
mouthwash

デンタルフロス
dentaru furosu
dental floss





ヘチマ
hechima
loofah

スポンジ
sponji
sponge



軽石
karuishi
pumice stone



背中洗いブラシ
senaka arai burashi
back brush



デオドラント
deodoranto
deodorant

石鹸皿
sekken-zara
soap dish



石鹸
sekken
soap

シャワージェル
shawā jeru
shower gel



フェースクリーム
fēsu kurīmu
face cream



バブルバス
baburu basu
bubble bath



バスローブ
basurōbu
bathrobe

ハンドタオル
hando taoru
hand towel



タオル
taoru
towels

バスタオル
basu taoru
bath towel



ボディローション
bodi rōshon
body lotion



タルカムパウダー
tarukamu paudā
talcum powder

髭剃り higeshori • shaving



電気剃刀
denki kamisori
electric razor



髭剃りクリーム
higeshori kurīmu
shaving cream



使い捨てカミソリ
tsukaisute kamisori
disposable razor



カミソリの刃
kamisori no ha
razor blade



アフターシェーブ
afutāshēbu
aftershave

子供部屋 kodomobeya • nursery

ベビーケア bebī kea • baby care



睡眠 suimin • sleeping

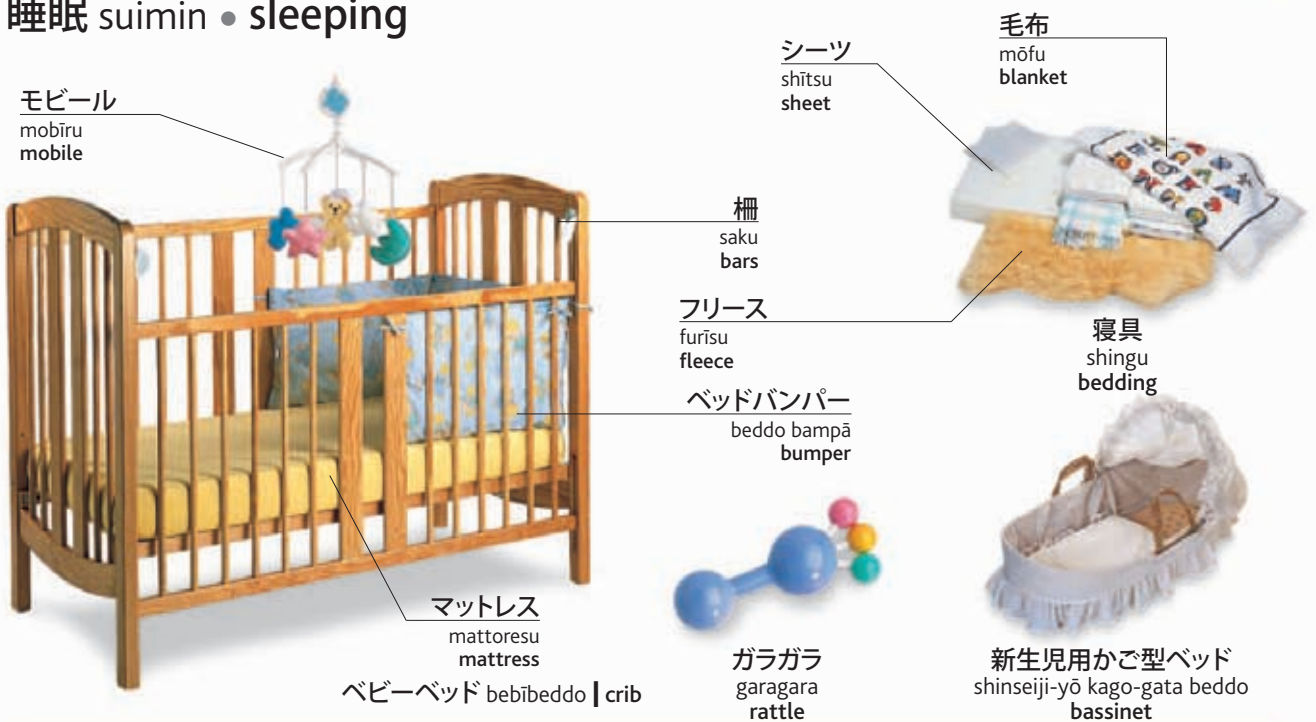

遊び asobi • playing



人形
ningyō
doll

縫いぐるみ
nuigurumi
soft toy



ドールハウス
dōru hausu
dollhouse



子供の家
kodomo no ie
playhouse

安全用品
anzen yōhin
• safety

戸棚ロック
todana rokku
child lock



ベビーモニター
bebī monitā
baby monitor



おもちゃ籠
omocha kago
toy basket

テディベア
tedibea
teddy bear

おもちゃ
omocha
toy



ボール
bōru
ball

ベビーサークル
bebīsākuru
playpen



ベビーゲート
bebī gēto
stair gate

食事 shokuji
• eating



ハイチェア
haichea
high chair

乳首
chikubi
nipple



ベビー用マグカップ
bebī-yō magu kappu
drinking cup

哺乳瓶
honyūbin
bottle

外出 gaishutsu • going out



ベビーカー
bebīkā
stroller



乳母車
ubaguruma
baby carriage

フード
fūdo
hood



キャリーコット
kyarīkotto
infant carrier



おむつ
omutsu
diaper

おむつ替えバッグ
omutsu kae baggu
diaper bag



ベビースリング
bebī suringu
baby sling

ユティリティールーム yutiriti rūmu • utility room

洗濯 sentaku • laundry

汚れ物
yogoremono
dirty washing



洗濯物入れ
sentakumono ire
laundry basket



洗濯機
sentakki
washing machine



洗濯乾燥機
sentaku kansōki
washer-dryer



乾燥機
kansōki
tumble dryer

洗濯物
sentakumono
clean clothes



洗濯かご
sentakukago
laundry basket

洗濯バサミ
sentaku-basami
clothes pin



乾かす
kawakasu
dry (v)

物干用ロープ
monohoshi-yō rōpu
clothesline



アイロン台 airon dai | ironing board



アイロン
airon
iron

関連用語 kanrenyōgo • vocabulary

(汚れ物を洗濯機に) 入れる
(yogoremono o sentakki ni) ireru
load (v)

濯ぐ
susugu
rinse (v)

脱水する
dassui suru
spin (v)

脱水機
dassuiki
spin dryer

アイロンをかける
airon o kakeru
iron (v)

柔軟仕上げ剤
jūnan shiagezai
fabric softener

この洗濯機は、どうやって使うのですか。
kono sentakki wa dōyatte tsukaunodesuka?
How do I operate the washing machine?

色物／白系の設定は何ですか。
iromono/shirokei no settei wa nandesuka?
What is the setting for colors/whites?

掃除道具 sōji dōgu • cleaning equipment



掃除 sōji • activities



擦る
kosuru
clean (v)



洗う
arau
wash (v)



拭く
fuku
wipe (v)



ゴシゴシ洗う
goshigoshi arau
scrub (v)



擦り取る
kosuritoru
scrape (v)



箒
hōki
broom

掃く
haku
sweep (v)



埃を払う
hokori o harau
dust (v)



磨く
migaku
polish (v)

作業場 sagyōba • workshop



ジグソー
jigusō
jigsaw



電池パック
denchi paku
battery pack



チャック
chakku
chuck

ドリルビット
doriru bitto
drill bit



グルーガン
gurū gan
glue gun



万力
manriki
vice



クランプ
kurampu
clamp

サンダー
sandā
sander

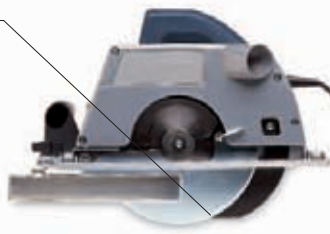

鋸刃
nokogiri-ba
blade

丸鋸
marunoko
circular saw



作業台
sagyōdai
workbench

木工用接着剤
mokkō-yō setchakuzai
wood glue

ルーター
rūtā
router

鉋屑
kannakuzu
wood shavings



工具棚
kōgu-dana
tool rack

ハンドドリル
hando doriru
bit brace

延長コード
enchō kōdo
extension cord

テクニック tekunikku • techniques



切る
kuru
cut (v)



(鋸で) 切る
(nokogiri de) kuru
saw (v)



穴をあける
ana o akeru
drill (v)



(金槌で) 打つ
(kanazuchi de) utsu
hammer (v)



鉋をかける
kanna o kakeru
plane (v)



旋盤加工する
sembankō suru | turn (v)

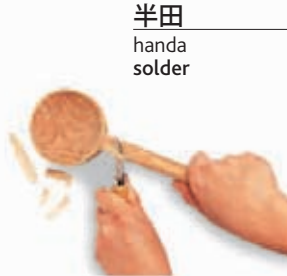

半田
handa
solder

削る
kezuru | carve (v)



半田付ける
handazuke suru | solder (v)

材料 zairyō • materials

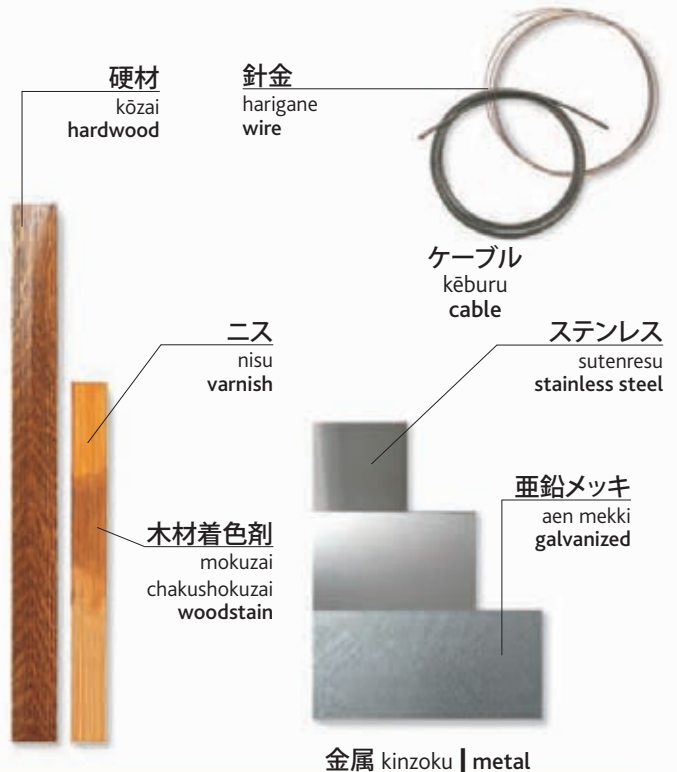
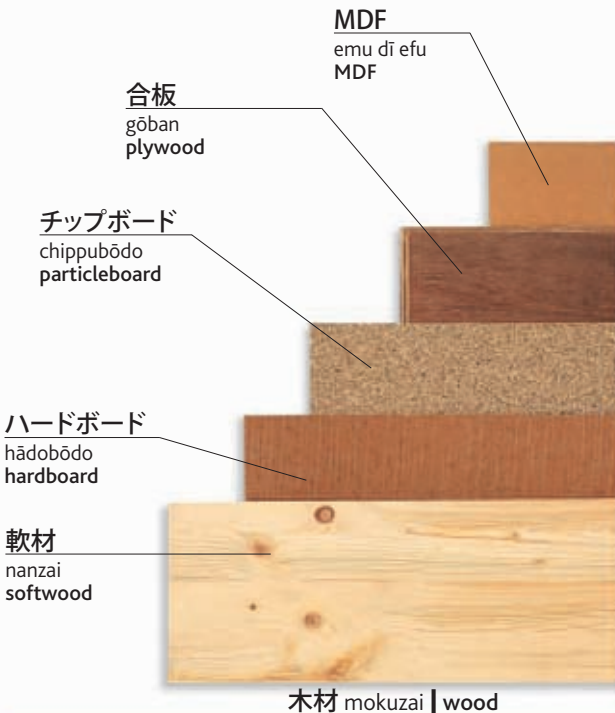

工具箱 dōgubako • toolbox

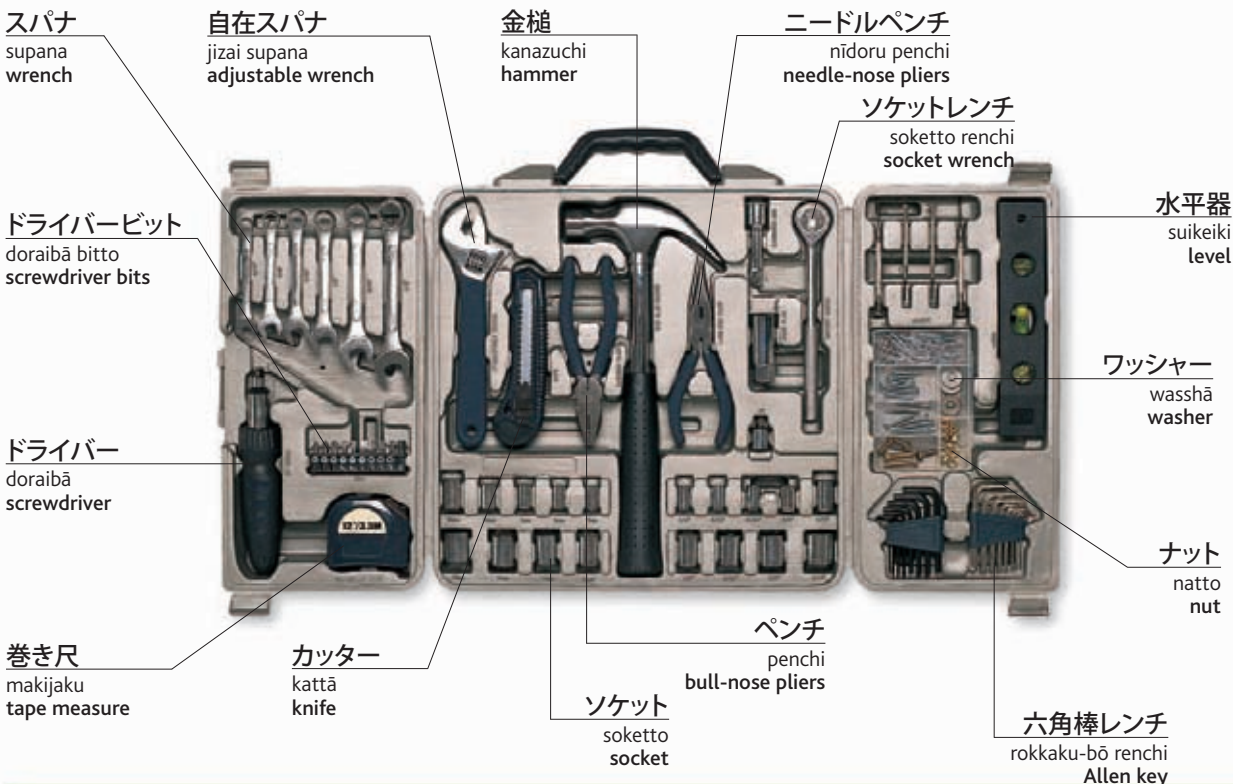

ドリルビット doriru bitto • drill bits

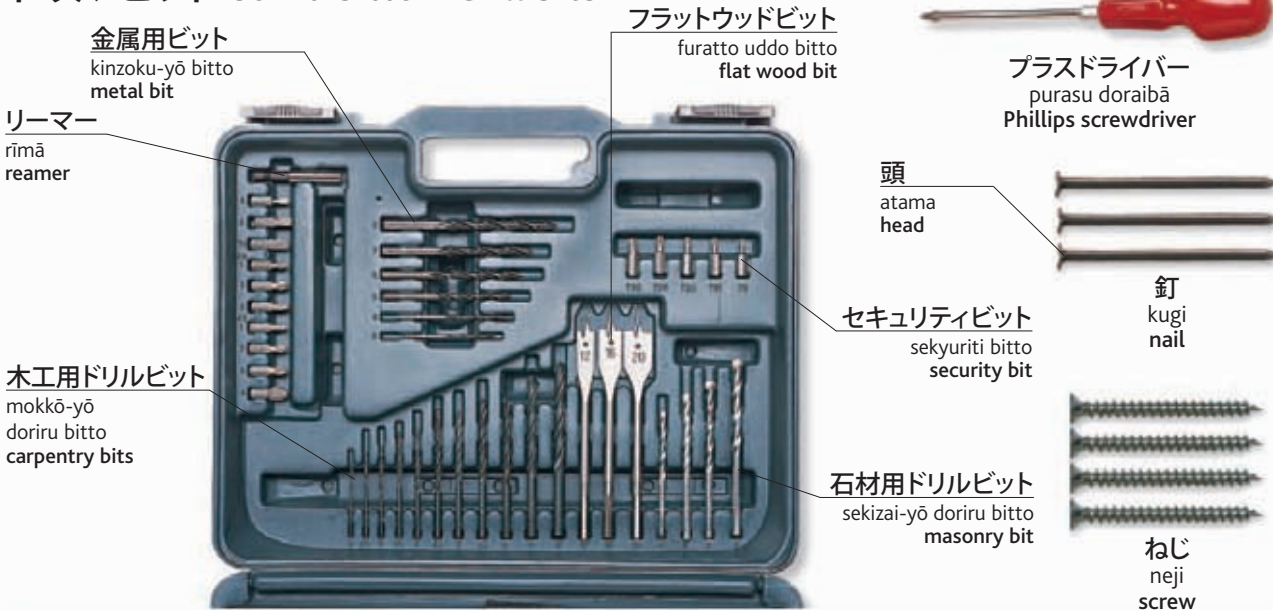

ワイヤーストリッパー
waiyā sutorippā
wire strippers

ワイヤーカッター
waiyā kattā
wire cutters

半田ごて
handagote
soldering iron

絶縁テープ
zetsuen tēpu
electrical tape

半田
handa
solder

カッターナイフ
kattā naifu
scalpel

糸鋸
itonoko
fretsaw

胴付き鋸 dōtsuki noko | tenon saw

保護めがね
hogo megane
safety goggles

鉋
kanna
plane

手引き鋸
tebiki noko
handsaw

ハンドドリル
hand odoriru
hand drill

スチールウール
suchīru'ūru
steel wool

マイターボックス
maitā bokkusu
miter block

弓鋸
yuminoko
hacksaw

レンチ
renchi
wrench

鑿
nomi
chisel

紙やすり
kami yasuri
sandpaper

吸引カップ
kyūin kappu
plunger

やすり
yasuri
file

砥石
toishi
sharpening stone

パイプカッター paipu kattā | pipe cutter

内装工事 naisō kōji • decorating



鋏
hasami
scissors



クラフトナイフ
kurafuto naifu
utility knife



下げ振り
sagefuri
plumb line



スクレーパー
sukurēpā
scraper

内装工事職人
naisō kōji shokunin
decorator

壁紙
kabegami
wallpaper

脚立
kyatatsu
stepladder



壁紙刷毛
kabegami-bake
wallpaper brush

糊付け台
nori-zuke dai
pasting table

糊刷毛
noribake
pasting brush

壁紙用糊
kabegami-yō nori
wallpaper paste

バケツ
baketsu
bucket

壁紙を張り替える kabegami o harikaeru | wallpaper (v)



剥がす hagasu | strip (v)



埋める umeru | fill (v)



研磨する kenma suru | sand (v)



漆喰を塗る shikkui o nuru | plaster (v)



壁紙を貼る kabegami o haru | hang (v)



タイルを貼る tairu o haru | tile (v)



ローラー
rōrā
roller



ローラー受け皿
rōrā ukezara
paint tray



ペンキ
penki
paint

刷毛
hake
brush



スポンジ
suponji
sponge



マスキングテープ
masukingu tēpu
masking tape



サンドペーパー
sandopēpā
sandpaper

塗料バケツ
toryō baketsu
paint can

つなぎ
tsunagi
overalls

養生シート
yōjō shīto
drop cloth



テレピン油
terepin-yu
turpentine



塗料用シンナー
toryō-yō shinnā
paint thinner

充填剤
jūtenzai
filler

塗装する tosō suru | paint (v)

関連用語 kanrenyōgo • vocabulary

漆喰
shikkui
plaster

艶出し
tsuyadashi
gloss

エンボス壁紙
embosu kabegami
embossed paper

下塗り
shitanuri
undercoat

シーラー
shīrā
sealant

ニス
nisu
varnish

艶消し
tsuyakeshi
mat

裏打ち紙
urauchi-gami
lining paper

上塗り
uwanuri
top coat

溶剤
yōzai
solvent

エマルション
emarushon
emulsion

ステンシル
sutenshiru
stencil

プライマー
puraimā
primer

防腐剤
bōfuzai
preservative

グラウト
gurauto
grout

庭 niwa • garden

庭の様式 niwa no yōshiki • garden styles



テラスガーデン terasu gāden | patio garden



フォーマルな庭園 fōmaru-na teien | formal garden



コテージガーデン
kotēji gāden
cottage garden



ハーブ園
hābu-en
herb garden



屋上庭園
okujō teien
roof garden



石庭
sekitei
rock garden



中庭 nakaniwa | courtyard



ウォーターガーデン
wōtā gāden
water garden

庭のアクセント niwa no akusento • garden features



ハンギングバスケット
hangingu basuketto
hanging basket



トレリス torerisu | trellis



パーゴラ
pāgora
arbor

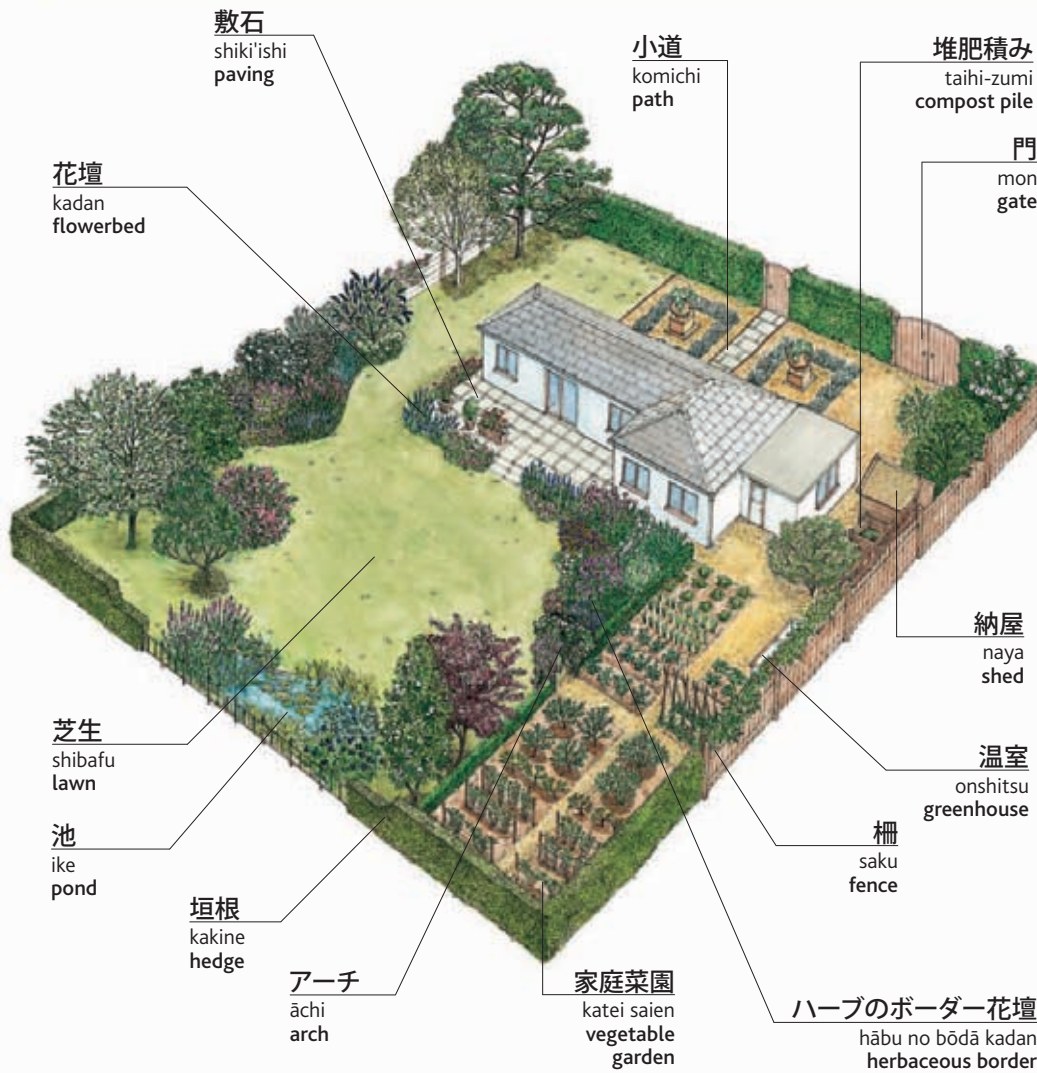

土壌 dojō

• soil



表土
hyōdo
topsoil



砂土
sunatsuchi
sand



石灰質土壌
sekkai-shitsu dojō
chalk



沈泥
chindei
silt



粘土
nendo
clay



デッキ
dekki
deck



噴水 funsui | fountain

庭の植物 niwa no shokubutsu • garden plants

植物の種類 shokubutsu no shurui • types of plants



一年草
ichinensō
annual



二年草
ninensō
biennial



多年草
tanensō
perennial



球根植物
kyūkon shokubutsu
bulb



シダ
shida
fern



い草
igusa
rush



竹
take
bamboo



雑草
zassō
weed



ハーブ
hābu
herb



水草
mizukusa
water plant



木
ki
tree



落葉樹
rakuyōju
deciduous



椰子の木
yashi no ki
palm



針葉樹
shin'yōju
conifer



常緑樹
jōryokuju
evergreen



トピアリー
topiari
topiary



高山植物
kōzan shokubutsu
alpine



多肉植物
taniku shokubutsu
succulent



サボテン
saboten
cactus

植木
ueki
potted plant

陰性植物
insei shokubutsu
shade plant

蔓性植物
tsurusei shokubutsu
climber

顕花性低木
kenkasei teiboku
flowering shrub

グランドカバー
gurando kabā
ground cover



匍匐植物
hofuku shokubutsu
creeper

観葉植物
kan'yō
shokubutsu
ornamental

草
kusa
grass

園芸用品 engei yōhin • garden tools



ショベル
shoberu
spade



フォーク
fōku
fork



雑草刈り鋏
zassō kari-basami
long-handled shears



熊手
kumade
lawn rake



レーキ
rēki
rake



鍬
kuwa
hoe



堆肥
taihi
compost



種
tane
seeds



骨粉
kotsufun
bone meal



砂利
jari
gravel



集草バッグ
shūsō baggu
grass bag

モーター
mōtā
motor

取っ手
totte
handle

シールド
shirudo
shield

トリマー
torimā
trimmer

芝刈り機
shibakariki
lawnmower



トラグ
toragu
trug



スタンド
sutando
stand

一輪台車
ichirin daisha
wheelbarrow



ハンドフォーク
hando fōku
hand fork



スコップ
sukoppu
trowel

刃
ha
blade



刈り込み鋏
karikomi-basami
shears



剪定鋸
sentei noko
hand saw



剪定鋏
sentei-basami
pruners



種蒔きトレイ
tanemaki torei
seed tray



殺虫剤
satchūzai
pesticide



篩
furui
sieve

植木鉢
uekibachi
plant pot



園芸用手袋
engi-yō tebukuro
gardening gloves



結束紐
kessoku himo
twine

ラベル
raberu
labels

ビニールタイ
binīru tai
twist ties

リングタイ
ringu tai
ring ties

支え棒
sasaebō
stakes



ゴム長靴
gomunagagutsu
rubber boots

水やり mizuyari • watering



霧吹き kirifuki | spray gun



スプリンクラー
supurinkurā
sprinkler

ノズル
nozuru
nozzle

じょうろ
jōro
watering can

ホース
hōsu
hosepipe

薔薇
bara
rose



ホースリール hōsu rīru | hose reel

園芸 engei • gardening

芝生
shibafu
lawn

花壇
kadan
flowerbed

芝刈り機
shibakariki
lawnmower



垣根
kakine
hedge

杭
kui
stake

芝刈りする shibakari suru | mow (v)



芝で覆う
shiba de ōu
sod (v)



刺す
sasuru
spike (v)



掃く
haku
rake (v)



刈り込む
karikomu
trim (v)



掘る
horu
dig (v)



種を植える
tane o ueru
sow (v)



追肥する
tsuihi suru
top-dress (v)



水をやる
mizu o yaru
water (v)



整枝する
seishi suru
train (v)



(終わった花を) 摘み取る
(owatta hana o) tsumitoru
deadhead (v)

噴霧する
funmu suru
spray (v)



支え棒
sasaebō
stake



接ぎ木する
tsugiki suru
graft (v)



切り枝
kirieda
cutting

枝分けする
edawake suru
propagate (v)



剪定する
sentei suru
prune (v)

(支えに) 繋ぐ
(sasaeni) tsunagu
stake (v)



植え替える
ue-kaeru
transplant (v)



除草する
josō suru
weed (v)



根覆いする
neōi suru
mulch (v)



収穫する
shūkaku suru
harvest (v)

関連用語 kanrenyōgo • vocabulary

栽培する
saibai suru
cultivate (v)

造園する
zōen suru
landscape (v)

肥料をやる
hiryō o yaru
fertilize (v)

篩にかける
furui ni kakeru
sieve (v)

有機
yūki
organic

苗
nae
seedling

心土
shindo
subsoil

手入れする
teire suru
tend (v)

(大きな鉢に) 植え替える
(ōkina hachi ni) ue-kaeru
pot up (v)

摘む
tsumu
pick (v)

空気に曝す
kūki ni sarasu
aerate (v)

排水
haisui
drainage

肥料
hiryō
fertilizer

除草剤
josōzai
weedkiller



職務 shokumu
services

緊急サービス kinkyū sābisu • emergency services

救急車 kyūkyūsha • ambulance



救急車 kyūkyūsha | ambulance



救急医療隊員 kyūkyū iryō tai'in
paramedic

担架
tanka
stretcher

警察 keisatsu • police



バッジ
bajji
badge

制服
seifuku
uniform

サイレン
sairin
siren

警光灯
keikōtō
lights



パトカー
patokā
police car



警察署
keisatsusho
police station

警棒
keibō
nightstick



手錠
tejō
handcuffs

拳銃
kenjū
gun

警官 keikan | police officer

関連用語 kanrenyōgo • vocabulary

警部
keibu
lieutenant

容疑者
yōgisha
suspect

申し立て
mōshitate
complaint

逮捕
taiho
arrest

犯罪
hanzai
crime

暴行
bōkō
assault

調査
chōsa
investigation

留置場
ryūchijō
jail cell

刑事
keiji
detective

指紋
shimon
fingerprint

押し込み強盗
oshikomi gōtō
burglary

告訴
kokuso
charge

消防隊 shōbōtai • fire department



火事 kaji | fire

煙

kemuri
smoke

ヘルメット

herumetto
helmet

ホース

hōsu
hose

バスケット

basuketto
cradle

水ジェット

mizu jetto
water jet

消防士
shōbōshi
firefighters

腕

ude
boom

梯子

hashigo
ladder

運転台

untendai
cab



消防署
shōbōsho
fire station



非常階段
hijō kaidan
fire escape



消防車
shōbōsha
fire engine



煙報知器
kemuri hōchiki
smoke alarm



火災警報機
kasai keihōki
fire alarm



防災斧
bōsai ono
ax



消火器
shōkaki
fire extinguisher



消火栓
shōkasen
hydrant

警察／消防車／救急車が必要です。
keisatsu/shōbōsha/kyūkyūsha ga hitsuyō
desu.
I need the police/fire department/
ambulance.

...で火が出ています。
... de hi ga dete imasu.
There's a fire at...

事故がありました。
jiko ga arimashita.
There's been an accident.

警察を呼んでください。
keisatsu o yonde kudasai!
Call the police!

銀行 ginkō • bank

客
kyaku
customer

窓口
madoguchi
window

出納係
suitō-gakari
cashier



リーフレット
rifuretto
brochures

カウンター
kauntā
counter

入金書
nyūkin-sho
deposit slips

デビットカード
debitto kādo
debit card

半券
hanken
stub

口座番号
kōza bangō
account number

署名
shomei
signature

金額
kingaku
amount



支店長
shitenchō
bank manager



クレジットカード
kurejitto kādo
credit card



小切手帳
kogitte-chō
checkbook

小切手
kogitte
check

関連用語 kanrenyōgo • vocabulary

貯金
chokin
savings

住宅ローン
jūtaku rōn
mortgage

支払い
shiharai
payment

入金する
nyūkin suru
deposit (v)

当座預金口座
tōzayokin kōza
checking account

税
zei
tax

超過引き出し
chōka hikidashi
overdraft

自動引き落とし
jidō hikiotoshi
automatic payment

銀行手数料
ginkō tesūryō
fee

普通預金口座
futsūyokin kōza
savings account

ローン
rōn
loan

金利
kinri
interest rate

出金依頼書
shukkin irai-sho
withdrawal slip

銀行振込
ginkō furikomi
electronic transfer

暗証番号
anshō bangō
PIN

硬貨
kōka
coin



金銭 kinsen | money

紙幣
shihei
bill

画面
gamen
screen

キーパッド
kipaddo
keypad



ATM ē tī emu | ATM

カード挿入口
kādo sōnyū-guchi
card slot

外貨 gaika • foreign currency



両替所
ryōgaejo
bureau de change



旅行小切手
ryokō kogitte
traveler's check



換算率
kansan ritsu
exchange rate

関連用語 kanrenyōgo • vocabulary

換金する
kankin suru
cash (v)

株
kabu
shares

額面金額
gakumen kingaku
denomination

配当
haitō
dividends

手数料
tesuryō
commission

会計士
kaikeishi
accountant

投資
tōshi
investment

ポートフォリオ
pōtoforio
portfolio

株式
kabushiki
stocks

エクイティ
ekuiti
equity

金融 kin'yū • finance

株価
kabuka
share price



金融アドバイザー
kin'yū adobaizā
financial advisor

ブローカー
burōkā
stockbroker



証券取引所 shōken torihiki-jo
stock exchange

これを両替できますか。
kore o ryōgae dekimasuka?
May I change this please?

今日の換算率は何ですか。
kyō no kansan ritsu wa nandesuka?
What is today's exchange rate?

コミュニケーション komyunikēshon • communications

郵便局員
yūbinkyoku-in
postal worker

窓口
madoguchi
window

秤
hakari
scale

カウンター
kauntā
counter



郵便局 yūbinkyoku | post office

消印
keshi'in
postmark

切手
kitte
stamp

住所
jūsho
address

郵便番号
yūbim-bangō
ZIP code



封筒 fūtō | envelope



郵便配達人
yūbin haitatsunin
mail carrier

関連用語 kanrenyōgo • vocabulary

手紙
tegami
letter

差出人住所
sashidashinin jūsho
return address

配達
haitatsu
delivery

壊れ物
kowaremono
fragile

折曲厳禁
orimage genkin
do not bend (v)

航空便
kōkūbin
by airmail

署名
shomei
signature

郵便為替
yūbin kawase
money order

郵便袋
yūbim-bukuro
mailbag

こちらが上
kochira ga ue
this way up

書留郵便
kakitome yūbin
registered mail

集荷
shūka
pickup

郵送料
yūsō-ryō
postage

電報
dempō
telegram

ファクス
fakusu
fax



郵便ポスト
yūbin posuto
mailbox



郵便受け
yūbin-uke
letter slot



小包
kozutsumi
package



宅配
takuhai
courier

電話 denwa • telephone

受話器
juwaki
handset

ベース
bēsu
base station



コードレス電話
kōdoresu denwa
cordless phone

留守番電話
rusuban denwa
answering machine



ビデオ電話
bideo denwa
video phone



公衆電話ボックス
kōshū-denwa bokkusu
telephone box



携帯電話
keitai denwa
cell phone

キーパッド
kīpaddo
keypad

受話器
juwaki
receiver

おつり
otsuri
coin return



硬貨式公衆電話
kōka-shiki kōshū-denwa
coin phone



カード式公衆電話
kādo-shiki kōshū-denwa
card phone

関連用語 kanrenyōgo • vocabulary

番号案内
bangō annai
directory assistance

電話に出る
denwa ni deru
answer (v)

交換手
kōkanshu
operator

...の電話番号を教えてください。
... no denwa bangō o oshiete kudasai.
Please give me the number for...

コレクトコール
korekuto kōru
collect call

携帯メール
keitai mēru
text message

通話中
tsūwa-chū
busy

...の局番は何ですか。
... no kyokuban wa nandesuka?
What is the area code for...?

電話する
denwa suru
dial (v)

音声メッセージ
onsei messēji
voice message

不通
futsū
disconnected

ホテル hoteru • hotel

ロビー robī • lobby

宿泊客
shukuhaku kyaku
guest

部屋の鍵
heya no kagi
room key

メッセージ
messēji
messages

分類棚
bunrui-dana
pigeonhole

フロント係
furonto-gakari
receptionist

宿泊者名簿
shukuhaku-
sha meibo
register

カウンター
kauntā
counter



フロント furonto | reception



荷物
nimotsu
luggage

カート
kāto
cart

ポーター pōtā | porter



エレベーター erebētā | elevator



部屋番号
heya bangō
room number

客室 kyakushitsu • rooms



シングルルーム
shinguru rūmu
single room

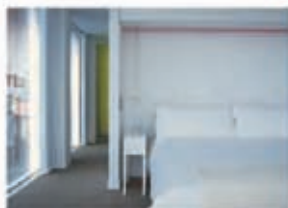

ダブルルーム
daburu rūmu
double room



ツインルーム
tsuin rūmu
twin room



客室付きバスルーム
kyakushitsu-zuki basurūmu
private bathroom

職務 shokumu • services



掃除サービス
sōji sābisu
maid service



洗濯サービス
sentaku sābisu
laundry service

朝食トレイ
chōshoku torei
breakfast tray



ルームサービス rūmu sābisu | room service



ミニバー
minibā
minibar



レストラン
restoran
restaurant



ジム
jimu
gym



プール
pūru
swimming pool

関連用語 kanrenyōgo • vocabulary

朝食付き
chōshoku-tsuki
bed and breakfast

3食付き
sanshoku-tsuki
all meals included

2食付き
nishoku-tsuki
some meals included

空室はありますか。
kūshitsu wa arimasuka?
Do you have any vacancies?

予約してあります。
yoyaku shite arimasu.
I have a reservation.

シングルルームをお願いします。
shinguru rūmu o onegai shimasu.
I'd like a single room.

3泊お願いします。
sampaku onegai shimasu.
I'd like a room for three nights.

一泊いくらですか。
ippaku ikura desuka?
What is the charge per night?

チェックアウトは何時ですか。
chekkuauto wa nanji desuka?
When do I have to vacate the room?





買い物 kaimono
shopping

ショッピングセンター shoppingu sentā • shopping center

アトリウム
atoriumu
atrium

看板
kaban
sign

エレベーター
erebētā
elevator



3階
sangai
second floor

2階
nikai
first floor

エスカレーター
esukarētā
escalator

1階
ikkai
ground floor

客
kyaku
customer

関連用語 kanrenyōgo • vocabulary

子供用品売場
kodomo yōhin uriba
children's department

売場案内
uriba annai
store directory

試着室
shichaku shitsu
fitting rooms

これは、いくらですか。
kore wa ikura desuka?
How much is this?

鞆売場
kaban uriba
luggage department

店員
ten'in
sales clerk

ベビールーム
bebī rūmu
baby changing facilities

これを交換できますか。
kore o kōkan dekimasuka?
May I exchange this?

靴売場
kutsu uriba
shoe department

カスタマーサービス
kasutamā sābisu
customer services

お手洗い
o-tearai
restrooms

デパート depāto • department store



紳士服
shinshi fuku
men's wear



婦人服
fujin fuku
women's wear



ランジェリー
ranjerī
lingerie



香水売場
kōsui uriba
perfume



化粧品
keshōhin
beauty



寝具・タオル類
shingu taoru rui
bed and bath



家具
kagu
home furnishings



小間物
komamono
notions



台所用品
daidokoro yōhin
kitchenware



陶磁器
tōjiki
china



電気製品
denki seihin
electronics



照明器具
shōmei kigu
lighting



スポーツ用品
supōtsu yōhin
sporting goods



玩具
omocha
toys



文房具
bumbōgu
stationery



食品売場
shokuhin uriba
groceries

スーパーマーケット sūpāmāketto • supermarket

通路
tsūro
aisle

棚
tana
shelf

ベルトコンベア
beruto kombea
conveyer belt

レジ係 特売品
reji-gakari tokubaihin
cashier specials



チェックアウト chekkuauto | checkout

客
kyaku
customer

レジ
reji
cash register

買い物袋
kaimono-bukuro
shopping bag



カート kato | cart

食料品
shokuryōhin
groceries

取っ手
totte
handle



籠 kago | basket



バーコード
bākōdo
bar code



バーコード読み取り装置 bākōdo yomitori sōchi | scanner



パン類
pan rui
bakery



乳製品
nyūseihin
dairy



シリアル食品
shiriaru shokuhin
breakfast cereals



缶詰
kanzume
canned food



菓子類
kashi rui
confectionery



野菜
yasai
vegetables



果物
kudamono
fruit



肉
niku
meat and poultry



魚
sakana
fish



デリカテッセン
derikatessen
deli



冷凍食品
reitō shokuhin
frozen food



インスタント食品
insutanto shokuhin
convenience food



飲物
nomimono
drinks



家庭用品
katei yōhin
household products



化粧品
keshōhin
toiletries



ベビー用品
bebī yōhin
baby products



電気製品
denki seihin
electrical goods



ペットフード
petto fūdo
pet food



雑誌 zasshi | magazines

薬局 yakkyoku • drugstore



アフターサンケア
afutāsankea
aftersun

サンスクリーン
sansukurin
sunscreen



日焼け止め
hiyakedome
sunblock



虫除け
mushiyoke
insect repellent



ウェットティッシュ
wetto tishshu
wet wipe



ティッシュ
tishshu
tissue



生理用ナプキン
seiri-yō napukin
sanitary napkin



タンポン
tampon
tampon



パンティライナー
panti rainā
panty liner



カプセル
kapuseru
capsule



錠剤
jōzai
tablet

計量スプーン
keiryō supūn
measuring spoon



シロップ
shiroppu
syrup

用法
yōhō
instructions

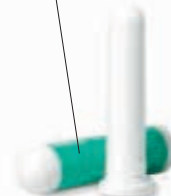

吸入器
kyūnyūki
inhaler



クリーム
kurīmu
cream



軟膏
nankō
ointment



ジェル
jeru
gel



坐薬
zayaku
suppository



液体薬
ekitai-gusuri
drops

スポイト
supoito
dropper



注射器
chūshaki
syringe

注射針
chūsha-bari
needle



スプレー
supurē
spray



粉薬
kona-gusuri
powder

関連用語 kanrenyōgo • vocabulary

鉄分
tetsubun
iron

インスリン
insurin
insulin

使い捨て
tsukaisute
disposable

医薬品
iyakuhin
medicine

痛み止め
itamidome
analgesic

カルシウム
karashiumu
calcium

副作用
fukusayō
side-effects

水溶性
suiyōsei
soluble

下剤
gezai
laxative

鎮静剤
chinsei-zai
sedative

マグネシウム
maguneshiumu
magnesium

使用期限
shiyō kigen
expiration date

用量
yōryō
dosage

下痢
geri
diarrhea

睡眠薬
suimin'yaku
sleeping pill

マルチビタミン
maruchi bitamin
multivitamins

酔い止め
yoidome
travel sickness pills

投薬
tōyaku
medication

のど飴
nodo ame
sore throat lozenge

抗炎症剤
kōenshō-zai
antiinflammatory

花屋 hanaya • florist

花
hana
flowers

百合
yuri
lily

アカシア
akashia
acacia

カーネーション
kâneshon
carnation

植木
ueki
potted plant



グラジオラス
gurajiorasu
gladiolus

菖蒲
ayame
iris

ひな菊
hinagiku
daisy

菊
kiku
chrysanthemum

かすみ草
kasumisō
gypsophila



アラセイトウ
araseitō
stocks



ガーベラ
gābera
gerbera



群葉
gun'yō
foliage



薔薇
bara
roses



フリージア
furijia
freesia

アレンジメント arenjimento • arrangements

花瓶
kabin
vase



蘭
ran
orchid



牡丹
botan
peony

花束
hanataba
bunch

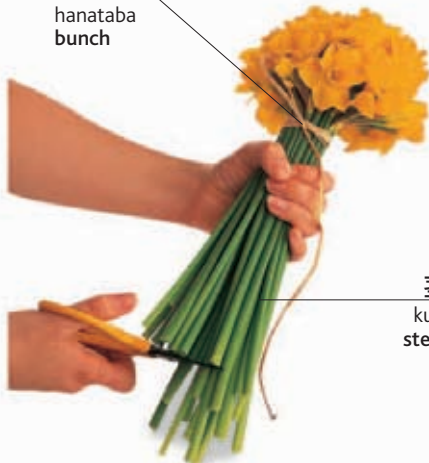

水仙
suisen
daffodil

茎
kuki
stem

蕾
tsubomi
bud



包装紙
hōsō-shi
wrapping

チューリップ chūrippu | tulip



リボン
ribon
ribbon

ブーケ
būke
bouquet



ドライフラワー
dorai furawā
dried flowers



ポプリ popuri | potpourri



花輪 hanawa | wreath



ガーランド
gārando
garland

メッセージを付けてください。
messēji o tsukete kudasai?
Can I attach a message?

何日ぐらい保ちますか。
nannichi gurai tamochimasuka?
How long will these last?

包んでください。
tsutsunde kudasai?
Can I have them wrapped?

香りがしますか。
kaori ga shimasuka?
Are they fragrant?

...に送っていただけますか。
... ni okutte itadakemasuka?
Can you send them to...?

...の花束をください。
... no hanataba o kudasai?
Can I have a bunch of... please?

新聞販売店 shimbun hambaiten • newsstand



煙草
tabako
cigarettes

煙草一箱
tabako hitohako
pack of cigarettes

マッチ
matchi
matches

宝くじ
takarakuji
lottery tickets

切手
kitte
stamps



絵葉書
ehagaki
postcard



漫画本
manga-bon
comic book



雑誌
zasshi
magazine



新聞
shimbun
newspaper

喫煙 kitsuen • smoking



刻み煙草
kizami tabako
tobacco



ライター
raitā
lighter

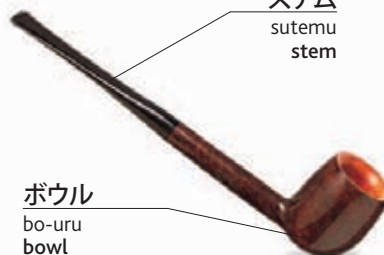

ボウル
bo-uru
bowl

パイプ
paipu
pipe

ステム
sutemu
stem



葉巻
hamaki
cigar

菓子屋 kashiya • confectioner

箱詰めチョコレート
hako-zume chokorēto
box of chocolates

チョコバー
chokobā
snack bar

ポテトチップス
poteto chippusu
chips



飴屋 ameya | sweet shop

関連用語 kanrenyōgo • vocabulary

ミルクチョコレート
miruku chokorēto
milk chocolate

キャラメル
kyarameru
caramel

スイートチョコレート
suīto chokorēto
dark chocolate

トラuffle
toraffuru
truffle

ホワイトチョコレート
howaito chokorēto
white chocolate

クッキー
kukki
cookie

ピクンミックス
pikkunmikkusu
pick-and-mix

飴
ame
hard candy

菓子 kashi • candy



チョコレート
chokorēto
chocolate



板チョコ
itachoko
chocolate bar



飴
ame
candies



棒付きキャンディー
bō-tsuki kyandī
lollipop



トフィー tofi | toffee



ヌガー
nugā | nougat



マシュマロ
mashumaro
marshmallow



ハッカ飴
hakka ame
mint



ガム
gamu
chewing gum



ゼリービーンズ
zerībinzu
jellybean



フルーツガム
furūtsu gamu
gum drop



甘草飴
kanzō ame
licorice

その他の店 sonota no mise • other stores



パン屋
pan'ya
bakery



ケーキ屋
kēkiya
pastry shop



肉屋
nikuya
butcher shop



魚屋
sakanaya
fish store



八百屋
yaoya
greengrocer



食料品店
shokuryōhin-ten
grocery store



靴屋
kutsuya
shoe store



金物屋
kanamonoya
hardware store



骨董屋
kottōya
antique shop



ギフトショップ
gifuto shoppu
gift shop



旅行代理店
ryokō dairiten
travel agency



宝石店
hōseki-ten
jewelry store



本屋
hon'ya
bookstore



レコード店
rekōdo-ten
record store



酒屋
sakaya
liquor store



ペットショップ
petto shoppu
pet store



家具屋
kaguya
furniture store



ブティック
butikku
boutique



仕立屋
shitateya
tailor



美容院
biyōin
salon

関連用語 kanrenyōgo • vocabulary

不動産屋
fudōsan-ya
real estate agency

カメラ屋
kamera-ya
camera store

園芸センター
engei sentā
garden center

健康食品店
kenkō shokuhin-ten
health food store

クリーニング屋
kurīningu-ya
dry cleaner's

画材屋
gazai-ya
art supply store

コインランドリー
koin randorī
laundromat

中古販売店
chūko hambai-ten
secondhand store



市場 ichiba | market



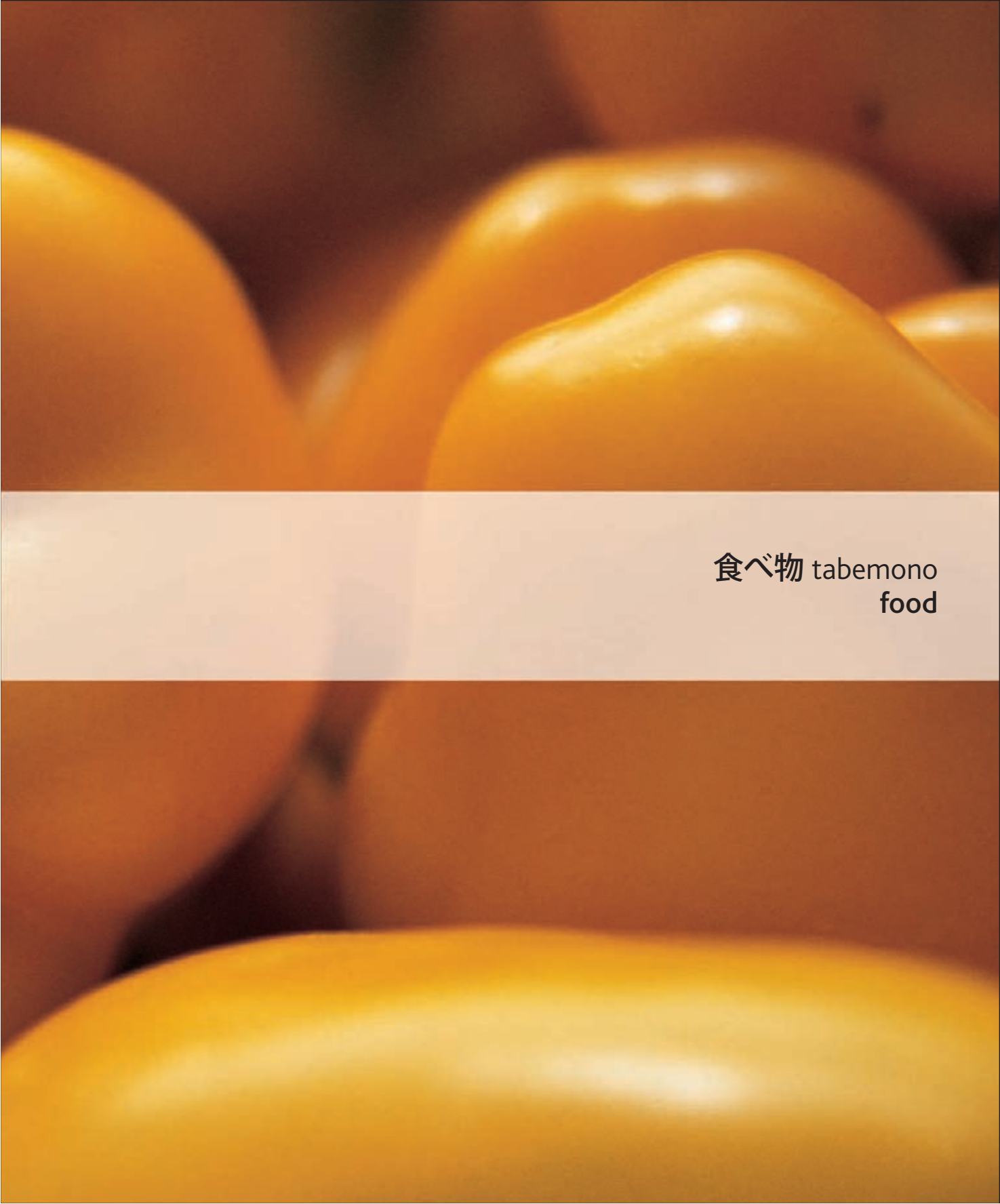

食べ物 tabemono
food

肉 niku • meat



ラム肉
ramu niku
lamb

肉屋
nikuya
butcher

肉フック
niku fukku
meat hook

秤
hakari
scale

研ぎ棒
togi-bō
knife sharpener

ベーコン
bēkon
bacon

ソーセージ
sōsēji
sausages

レバー
rebā
liver

関連用語 kanrenyōgo • vocabulary

豚肉
butaniku
pork

鹿肉
shika niku
venison

内蔵
naizō
offal

放し飼いの
hanashigai no
free range

調理済み肉
chōri-zumi niku
cooked meat

牛肉
gyūniku
beef

ウサギ肉
usagi niku
rabbit

保存処理
hozon shori
cured

有機性
yūki-sei
organic

白身肉
shiromi niku
white meat

子牛肉
ko-ushi niku
veal

タン
tan
tongue

薫製
kunsei
smoked

低脂肪肉
teishibō niku
lean meat

赤身肉
akami niku
red meat

切り身 kirimi • cuts

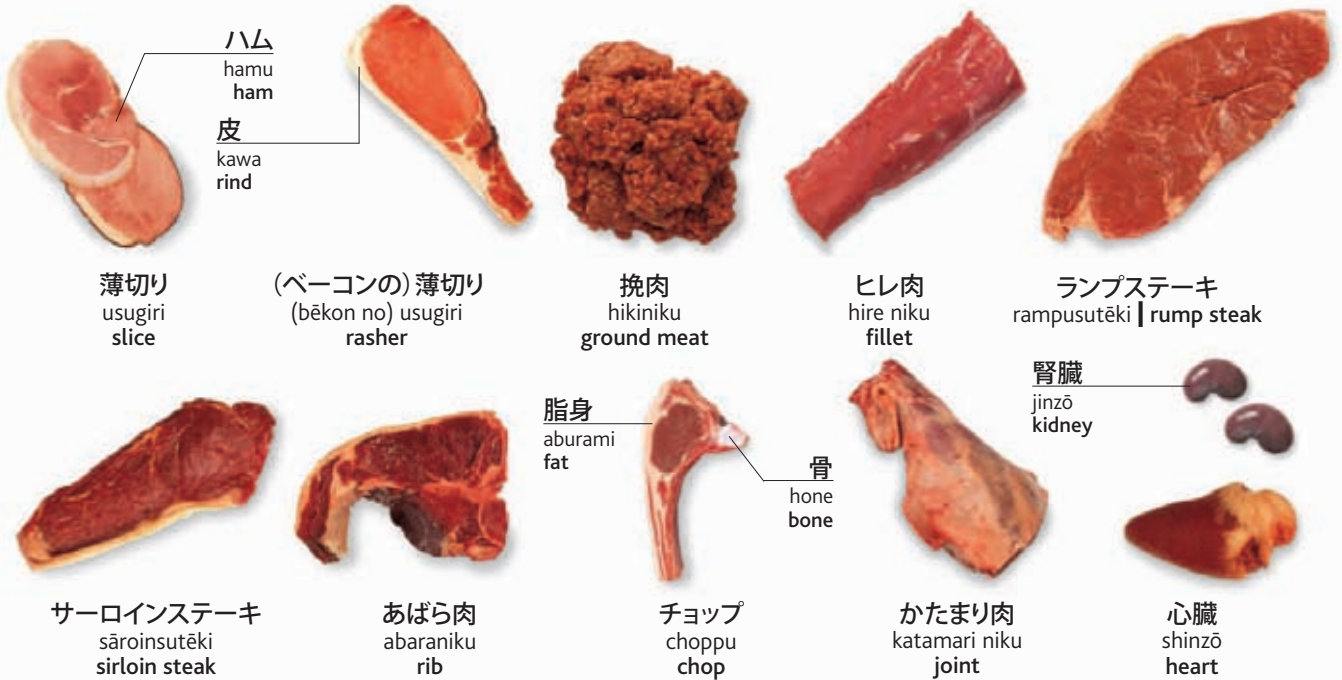

鳥肉 toriniku • poultry

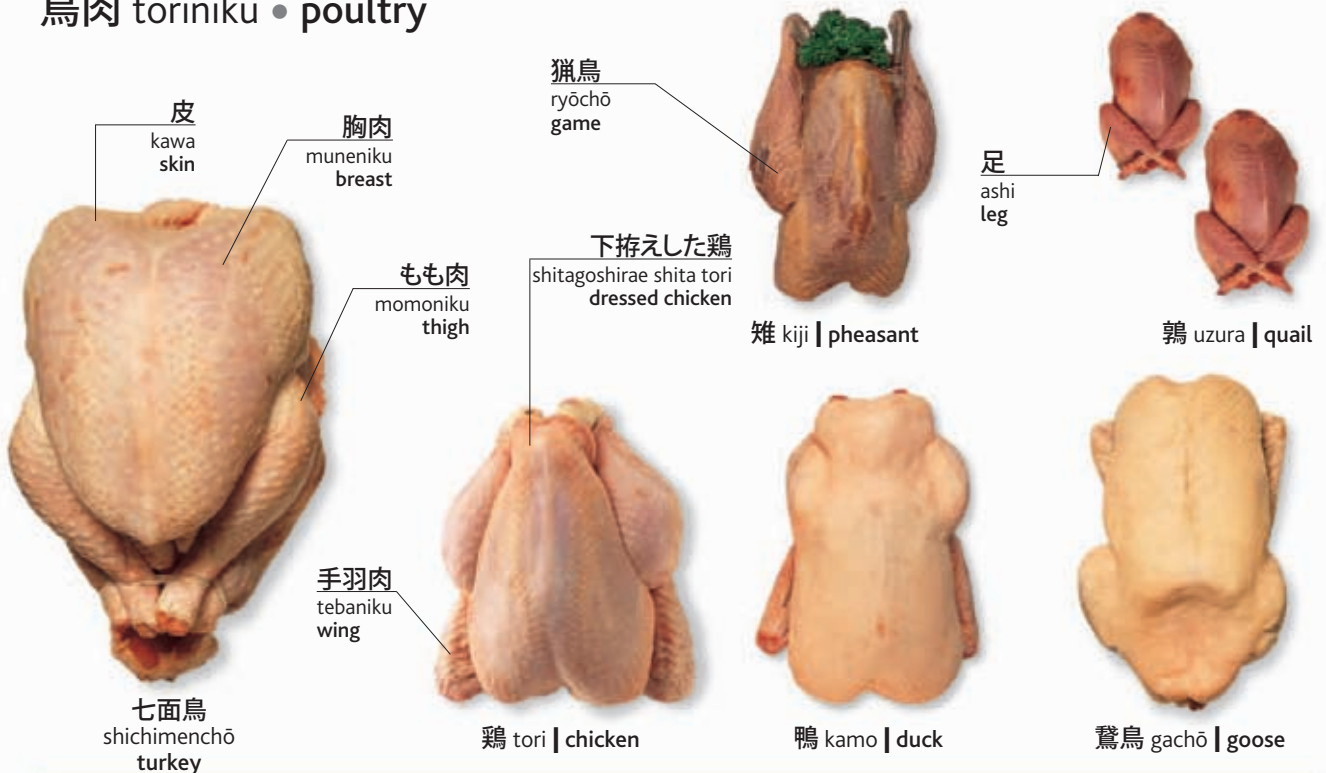

魚 sakana • fish

剥き海老
mukiebi
peeled shrimp

氷
kōri
ice

ヒメジ
himeji
red mullet

オヒョウの切り身
ohyō no kirimi
halibut fillets

虹鱒
nijimasu
rainbow trout

ガンギエイのヒレ
gangiei no hire
skate wings

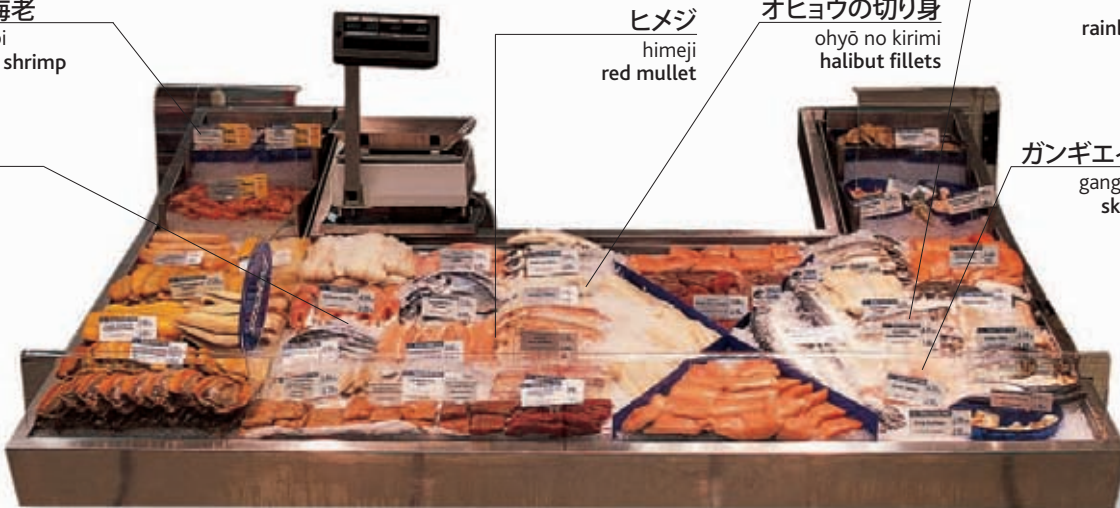

魚屋
sakanaya
fishmonger's



アンコウ
ankō
monkfish



鯖
saba
mackerel



鱒
masu
trout



メカジキ
mekajiki
swordfish



ドーバーカレイ
dōbā karei
Dover sole



レモンガレイ
remon garei
lemon sole



コダラ
kodara
haddock



鰯
iwashi
sardine



ガンギエイ
gangiei
skate



ホワイティング
howaitingu
whiting



スズキ
suzuki
sea bass



鮭 sake | salmon



鱈
tara
cod



鯛
tai
sea bream



鮪
maguro
tuna

海産物 kaisambutsu • seafood

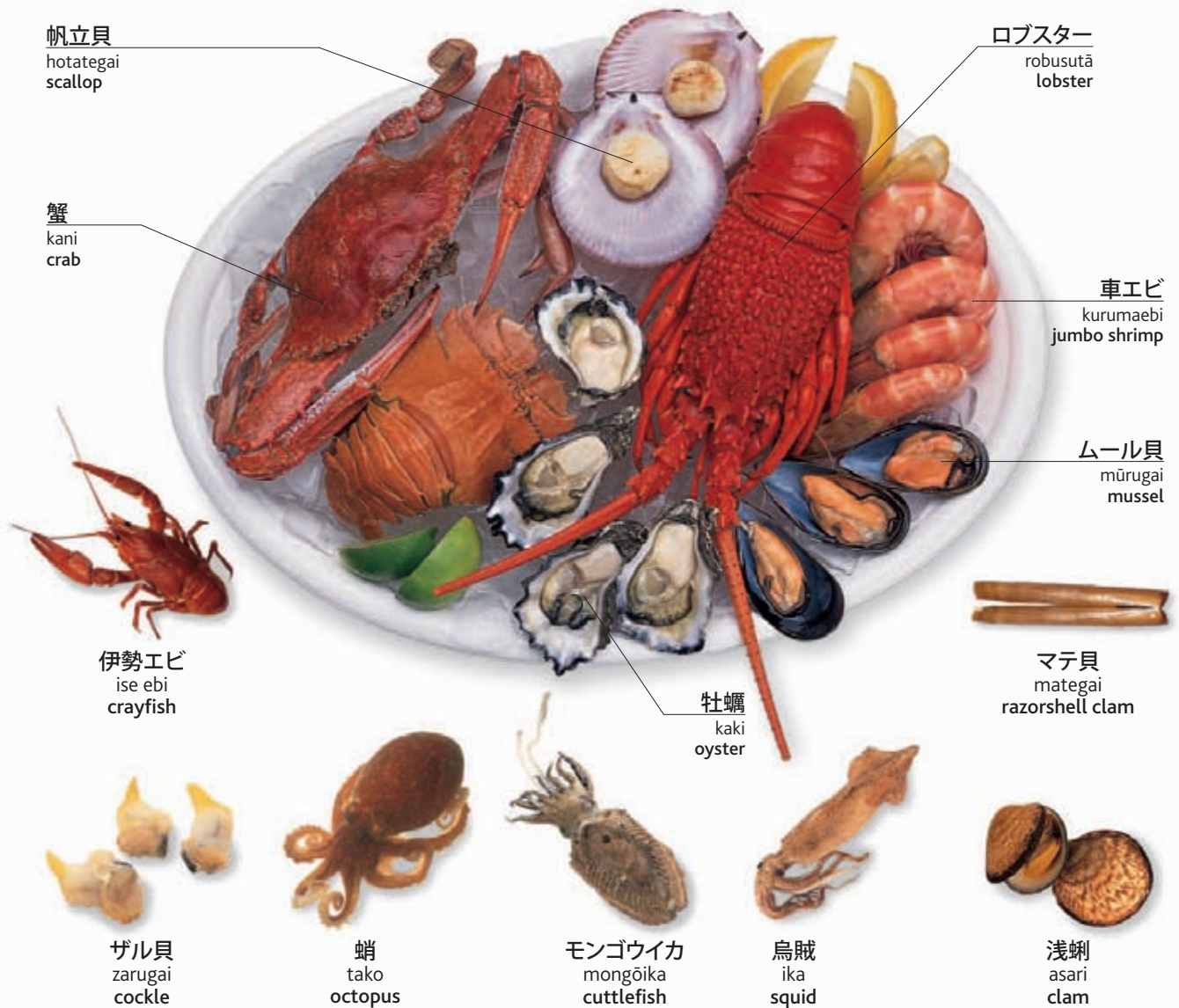

関連用語 kanrenyōgo • vocabulary

冷凍 reitō frozen	塩ふり shio-furi salted	薫製 kunsei smoked	鱗を取った uroko o totta descaled	切り身 kirimī fillet	厚切り atsu-giri loin	尾 o tail	骨 hone bone	鱗 uroko scale	寿司 sushi sushi	刺身 sashimi sashimi
新鮮 shinsen fresh	腸を取った wata o totta cleaned	皮を剥いた kawa o muita skinned	骨を取った hone o totta boned	おろした oroshita filleted	筒切り tsutsugiri steak	腸を取ってください。 wata o totte kudasai? Will you clean it for me?				

野菜1 yasai • vegetables 1



空豆
raimame
fava bean



ライ豆
sayamame
runner beans

実
mi
seed



インゲン豆
ingenmame
green beans



エンドウ豆
endōmame
peas



トウモロコシ
tōmorokoshi
corn



もやし
moyashi
bean sprouts



筍
takenoko
bamboo

莢
saya
pod



オクラ
okura
okra



セロリ
serori
celery



チコリ
chikori
chicory



茴香
uikyō
fennel



パルメット 椰子の芯
parumetto yashi no shin
palm hearts

関連用語 kanrenyōgo • vocabulary

白菜
hakusai
Chinese leaves

莖
kuki
stalk

種
tane
kernel

芯
shin
heart

有機野菜はありますか。
yūki yasai wa arimasuka?
Do you sell organic vegetables?

葉
ha
leaf

房
fusa
florete

先端
sentan
tip

有機(栽培)
yūki (saibai)
organic

これは地元産ですか。
kore wa jimoto-san desuka?
Are these grown locally?



ロケットサラダ
roketto sarada
arugula



クレソン
kureson
watercress



赤チコリ
aka chikori
radicchio



芽キャベツ
mekyabetsu
brussels sprouts



フダンソウ
fudansou
Swiss chard



ケール
keru
kale



ギシギシ
gishigishi
sorrel



エンダイブ
endaibu
endive



タンポポ
tampopo
dandelion



ホウレン草
horensou
spinach



コールラビ
korurabi
kohlrabi



チンゲン菜
chingensai
bok choy



レタス
retasu
lettuce



ブロッコリ
burokkori
broccoli



キャベツ
kyabetsu
cabbage



新キャベツ
shin kyabetsu
spring greens

野菜2 yasai • vegetables 2



関連用語 kanrenyōgo • vocabulary

プチトマト
puchi tomato
cherry tomato

タロ芋
taroimo
taro root

冷凍
reitō
frozen

苦い
nigai
bitter

ジャガイモを1キロください。
jagaimo o ichi kiro kudasai.
One kilo of potatoes, please.

人参
ninjin
carrot

菱の実
hishi no mi
water chestnut

生
nama
raw

硬い
katai
firm

1キロいくらですか。
ichi kiro ikura desuka?
What's the price per kilo?

新ジャガ
shinjaga
new potato

椎茸
shītake
shitake
mushrooms

辛い
karai
hot (spicy)

果肉
kaniku
flesh

あれは何と言いますか。
are wa nan to īmasuka?
What are those called?

セロリアック
seroriakku
celeriac

わさび
wasabi
Japanese
horseradish

甘い
amai
sweet

根
ne
root



薩摩芋
satsumaimo
sweet potato



山芋
yamaimo
yam



ビートルート
bītorūto
beet



ルタバガ
rutabaga
rutabaga



菊芋
kikuimo
jerusalem artichoke



西洋ワサビ
seiyouwasabi
horseradish



パースニップ
pāsunippu
parsnip



生姜
shōga
ginger



茄子
nasu
eggplant



トマト
tomato
tomato



スプリングオニオン
supringu onion
green onion



ニラネギ
niranegi
leek



エシャロット
esharotto
shallot



大蒜
ninniku
garlic

丁字
chōji
clove



トリュフ
toryufu
truffle

マッシュルーム
masshurūmu
mushrooms



胡瓜
kyūri
cucumber



ズッキーニ
zukkīni
zucchini



バターナットスクワッシュ
batānatto sukuwasshu
butternut squash



ドングリカボチャ
donguri kabocha
acorn squash



南瓜
kabocha
pumpkin

果物1 kudamono • fruit 1

柑橘類 kankitsu rui • citrus fruit



オレンジ
orenji
orange



クレメンティン
kurementin
clementine



アグリフルーツ
agurifurūtsu
ugli fruit

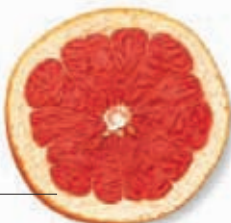

グレープフルーツ
gurēpufurūtsu
grapefruit

筋
suji
pith

房
fusa
segment



薩摩みかん
satsuma mikan
satsuma



タンジェリン
tanjerin
tangerine



ライム
raimu
lime

皮
kawa
zest



レモン
remon
lemon



金柑
kinkan
kumquat

石果 sekika • stone fruit



桃
momo
peach



ネクタリン
nektarin
nectarine



杏
anzu
apricot



プラム
puramu
plum



さくらんぼ
sakurambo
cherry

洋梨
yōnashi
pear

林檎
ringo
apple



果物籠 kudamono kago | basket of fruit

液果とメロン ekika to meron • berries and melons



苺
ichigo
strawberry



ラズベリー
razuberī
raspberry



メロン
meron
melon



葡萄
budō
grapes



ブラックベリー
burakkuberī
blackberry



レッドカラント
reddokaranto
redcurrant

皮
kawa
rind



ブラックカラント
burakkukaranto
blackcurrant

種
tane
seed



クランベリー
kuranberī
cranberry



ホワイトカラント
howaitokaranto
whitecurrant

果肉
kaniku
flesh



ブルーベリー
burūberī
blueberry



西瓜
suika
watermelon



ローガンベリー
rōganberī
loganberry

関連用語 kanrenyōgo • vocabulary

ダイオウ
daiō
rhubarb

酸っぱい
suppai
sour

パリッとした
parittoshita
crisp

果汁
kajū
juice

熟していますか。
jukushite imasuka?
Are they ripe?

繊維
sen'i
fiber

新鮮
shinsen
fresh

腐った
kusatta
rotten

芯
shin
core

試食できますか。
shishoku dekimasuka?
May I try one?

甘い
amai
sweet

みずみずしい
mizumizushī
juicy

(柔らかい) 果肉
(yawarakai) kaniku
pulp

種なし
tanenashi
seedless

何日ぐらい保ちますか。
nannichi gurai tamochimasuka?
How long will they keep?



グーズベリー
gūzuberī
gooseberry

果物2 kudamono 2 • fruit 2



マルメロ
marumero
quince



パッションフルーツ
passhonfurūtsu
passion fruit



皮
kawa
skin

バナナ
banana
banana



グアバ
guaba
guava



石榴
zakuro
pomegranate



柿
kaki
persimmon



フェイスジョア
fejjoa
fejjoa



ウチワサボテン
uchiwasaboten
prickly pear



スターフルーツ
sutāfurūtsu
starfruit



コダチトマト
kodachitomato
tamarillo

ナッツとドライフルーツ nattsu to doraifurūtsu • nuts and dried fruit



松の実
matsu no mi
pine nut



ピスタチオ
pisutachio
pistachio



カシューナッツ
kashūnattsu
cashew



ピーナッツ
pīnattsu
peanut



ヘーゼルナッツ
hēzerunattsu
hazelnut



ブラジルナッツ
burajirunattsu
brazil nut



ピーカンナッツ
pīkannattsu
pecan



アーモンド
āmondo
almond



胡桃
kurumi
walnut



栗
kuri
chestnut



マカデミアナッツ
makademianattsu
macadamia



無花果
ichijiku
fig



棗
natsume
date



李
sumomo
prune

殻
kara
shell



果肉
kaniku
flesh



サルタナレーズン
sarutana rēzun
seedless raisin



干し葡萄
hoshibudō
raisin



カラント
karanto
currant

ココナッツ
kokonattsu
coconut

関連用語 kanrenyōgo • vocabulary

青い
aoi
green

硬い
katai
hard

仁
nin
kernel

塩
shio
salted

煎った
itta
roasted

殻を剥いた
kara o muita
shelled

砂糖漬け果物
satōzuke
kudamono
candied fruit

完熟
kanjuku
ripe

柔らかい
yawarakai
soft

乾燥
kansō
desiccated

生
nama
raw

季節もの
kisetsu mono
seasonal

丸ごと
marugoto
whole

熱帯果実
nettai kajitsu
tropical fruit

穀類と豆類 kokurui to mamerui • grains and legumes

穀類 kokurui • grains



小麦
komugi
wheat



からす麦
karasumugi
oats



大麦
omugi
barley



キビ
kibi
millet



トウモロコシ
tomorokoshi
corn

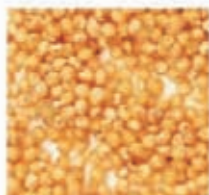

キノア
kinoa
quinoa

関連用語 kanrenyōgo • vocabulary

種 tane seed	香りのある kaori no aru fragranced	スピードクック supīdo kukku easy cook
殻 kara husk	シリアル食品 shiriaru shokuhin cereal	長粒 chōryū long-grain
穀粒 kokuryū kernel	全粒 zenryū whole-grain	短粒 tanryū short-grain
乾燥 kansō dry	(水に) 漬ける (mizu ni) tsukeru soak (v)	
新しい atarashī fresh		

米 kome • rice



白米
hakumai
white rice



玄米
genmai
brown rice



野生米
yasei mai
wild rice



プディングライス
pudinguraisu
arborio rice

加工穀物 kakō kokumotsu • processed grains



クスクス
kusukusu
couscous



粗挽き麦
arabiki mug
cracked wheat



セモリナ
semorina
semolina



糠
fusuma
bran

豆類 mamerui • beans and peas



ライ豆
raimame
butter beans



いんげん豆
ingenmame
navy beans



金時豆
kintoki mame
red kidney beans



小豆
azuki
aduki beans



空豆
soramame
lima beans



大豆
daizu
soybeans



黒目豆
kurome mame
black-eyed beans



鶉豆
uzura mame
pinto beans



緑豆
ryukutō
mung beans



フラジョレ豆
furajore mame
flageolet beans



レンズ豆
renzumame
brown lentils



赤レンティル
aka rentiru
red lentils



グリーンピース
gurin pīsu
green peas



雛豆
hiyoko mame
chick peas



スプリットピー
supuritto pī
split peas

種 tane • seeds



南瓜の種
kabocha no tane
pumpkin seed



辛子の種
karashi no tane
mustard seed



キャラウェイシード
kyarawei shīdo
caraway



胡麻
goma
sesame seed



向日葵の種
himawari no tane
sunflower seed

ハーブと香辛料 hābu to kōshinryō • herbs and spices

香辛料 kōshinryō • spices



バニラ banira | vanilla



ナツメグ
natsumeggu
nutmeg



メース
mēsu
mace



ウコン
ukon
turmeric



クミン
kumin
cumin



ブーケガルニ
būkegaruni
bouquet garni



オールスパイス
ōrusupaisu
allspice



胡椒の実
koshō no mi
peppercorn



フェヌグreek
fenugurīku
fenugreek



唐辛子
tōgarashi
chili pepper

丸ごと
marugoto
whole

つぶした
tsubushita
crushed



サフラン
safuran
saffron



カルダモン
karudamon
cardamom



カレー粉
karēko
curry powder



パウダー
paudā
ground



パプリカ
papurika
paprika

フレーク
furēku
flakes



大蒜
ninniku
garlic

ハーブ hābu • herbs

スティック
sutikku
sticks



シナモン
shinamon
cinnamon



レモングラス
remongurasu
lemongrass



クローブ
kurōbu
cloves



大茴香
daiiikyō
star anise



生姜
shōga
ginger

茴香の種
uikyō no tane
fennel seeds



茴香
uikyō
fennel



朝葱
asatsuki
chives



ハッカ
hakka
mint



タラゴン
taragon
tarragon



マジョラム
majoramu
marjoram



ローリエ
rōrie
bay leaf



タイム
taimu
thyme



バジリコ
bajiriko
basil



パセリ
paseri
parsley



セージ
sēji
sage



オレガノ
oregano
oregano



コリアンダー
koriandā
cilantro



ディル
diru
dill



ローズマリー
rōzumarī
rosemary

瓶詰め食品 binzume shokuhin • bottled foods



甘味スプレッド kanmi supureddo • sweet spreads



薬味とスプレッド yakumi to supureddo
 ● condiments and spreads



林檎酢
ringo su
cider vinegar

マヨネーズ
mayonēzu
mayonnaise



チャツネ
chatsune
chutney



モルト酢
moruto su
malt vinegar



バルサミコ酢
barusamiko su
balsamic vinegar



ワイン酢
wain su
wine vinegar

酢
su
vinegar

瓶
bin
bottle



ケチャップ
kechappu
ketchup



ソース
sōsu
sauce



イングリッシュマスタード
ingurisshu masutādo
English mustard



ディジョンマスタード
dijon masutādo
French mustard



粒マスタード
tsubu masutādo
whole-grain mustard

密封瓶
mippū bin
sealed jar



ピーナッツバター
pīnattsubatā
peanut butter



チョコレートスプレッド
chokorēto supureddo
chocolate spread



瓶詰めフルーツ
binzume furūtsu
preserved fruit

関連用語 kanrenyōgo

● vocabulary

コーン油
kōn yu
corn oil

落花生油
rakkasei yu
peanut oil

サラダ油
sarada yu
vegetable oil

菜種油
natane abura
canola oil

コールドプレス油
kōrudopuresu yu
cold-pressed oil

醤油
shōyu
soy sauce

米酢
komezu
rice vinegar

乳製品 nyūseihin • dairy produce

チーズ chīzu • cheese



ミルク miruku • milk





バター
batā
butter



マーガリン
māgarin
margarine



生クリーム
nama kurīmu
cream



シングルクリーム
shinguru kurīmu
light cream



ダブルクリーム
daburu kurīmu
double cream



ホイップクリーム
hoippu kurīmu
whipped cream



サワークリーム
sawā kurīmu
sour cream



ヨーグルト
yōguruto
yogurt



アイスクリーム
aisukurīmu
ice cream

卵 tamago • eggs

卵黄
ran'ō
yolk

卵白
rampaku
egg white

殻
kara
shell

エッグカップ
eggu kappu
egg cup

ゆで卵 yudetamago | boiled egg



鶏卵
keiran
hen's egg



家鴨の卵
ahiru no tamago
duck egg



鵞鳥の卵
gachō no tamago
goose egg



鶉卵
uzura tamago
quail egg

関連用語 kanrenyōgo • vocabulary

低温殺菌
teionsakkin
pasteurized

ミルクセーキ
mirukuseki
milkshake

塩入り
shio-iri
salted

羊乳
yōnyū
sheep's milk

乳糖
nyūtō
lactose

ホモジナイズ
homojinaizu
homogenized

低温殺菌していない
teionsakkin shiteinai
unpasteurized

フローズンヨーグルト
furōzun yōguruto
frozen yogurt

無塩
muen
unsalted

バターミルク
batāmiruku
buttermilk

無脂肪
mu-shibō
fat-free

粉乳
funnyū
powdered milk

パンと小麦粉 pan to komugiko • breads and flours

スライス食パン
suraisu shokupan
sliced bread

ケシの実
keshi no mi
poppy seeds

ライ麦パン
raimugi pan
rye bread

バゲット
bagetto
baguette



パン屋 pan'ya | bakery

パン作り pan-zukuri • making bread



白小麦粉
shiro komugiko
white flour



黒小麦粉
kuro komugiko
brown flour



全粒粉
zenryū-fun
whole-wheat flour



酵母
kōbo
yeast



篩にかける furui ni kakeru
sift (v)



混ぜる mazeru | mix (v)

パン生地
pan kiji
dough



こねる koneru | knead (v)



焼く yaku | bake (v)



耳
mimi
crust

白パン
shiro pan
white bread



食パンの塊
shokupan no
katamari
loaf

黒パン
kuro pan
brown bread



全粒パン
zenryū pan
whole-wheat bread

スライス
suraisu
slice



グラナリブレッド
guranari bureddo
multigrain bread



とうもろこしパン
tōmorokoshi pan
cornbread



ソーダパン
sōda pan
soda bread



サワードウブレッド
sawādo-u bureddo
sourdough bread



フラットブレッド
furattobureddo
flatbread



ベーグル
bēguru
bagel



バップ
bappu | bun



ロールパン
rōrupan | roll



フルーツパン
furūtsu pan
fruit bread



種入りパン
tane-iri pan
seeded bread



ナン
nan
naan bread



ピタパン
pita pan
pita bread

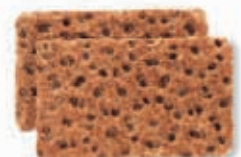

クリスプブレッド
kurisupu bureddo
crispbread

関連用語 kanrenyōgo • vocabulary

強力粉
kyōrikiko
bread flour

膨れる
fukureru
rise (v)

発酵させる
hakkō saseru
prove (v)

パン粉
panko
breadcrumbs

スライサー
suraisā
slicer

膨らし粉入り小麦粉
fukurashiko-iri komugiko
self-raising flour

薄力粉
hakurikiko
all-purpose flour

グレーズを塗る
gurēzu o nuru
glaze (v)

波形
namigata
flute

パン職人
pan shokunin
baker

ケーキとデザート kēki to dezāto • cakes and desserts

エクレア
ekurea
éclair

クリーム
kurīmu
cream

具
gu
filling

シュー皮
shū-gawa
choux pastry

パイ生地
pai kiji
puff pastry

フィロペストリー
firo pesutori
phyllo pastry



フルーツケーキ
furūtsu kēki
fruit cake

フルーツタルト
furūtsu taruto
fruit tart

メランゲ
merange
meringue

チョコレートを被せた
chokorēto o kabuseta
chocolate-coated

マフィン
mafin
muffin

スポンジケーキ
suponji kēki
sponge cake



ケーキ kēki | cakes

関連用語 kanrenyōgo • vocabulary

カスタードクリーム
kasutādo kurīmu
crème pâtissière

丸い小型パン
marui kogata pan
bun

ペストリー
pesutori
pastry

ライスプディング
raisu pudingu
rice pudding

一切れください。
hitokire kudasai?
May I have a slice please?

チョコレートケーキ
chokorēto kēki
chocolate cake

カスタード
kasutādo
custard

一切れ
hitokire
slice

お祝い
oiwai
celebration

チョコレートチップス
chokorêto chippusu
chocolate chip



スポンジフィンガー
suponji fingā
lady finger



フロレンティン
furorentin
florentine

トライフル
toraifuru
trifle

ビスケット bisuketto | biscuits



ムース
mūsu
mousse



シャーベット
shābetto
sorbet



クリームパイ
kurīmu pai
cream pie



プリン
purin
crème caramel

お祝い用ケーキ oiwai-yō kēki • celebration cakes

最上段
saijōdan
top tier

リボン
ribon
ribbon

下段
gedan
bottom tier

アイシング
aishingu
icing

マジパン
majipan
marzipan



ウェディングケーキ wedingu kēki
wedding cake

飾り
kazari
decoration

誕生日ケーキの蝋燭
tanjōbi kēki no rōsoku
birthday candles

吹き消す
fukikesu
blow out (v)



誕生日ケーキ tanjōbi kēki | birthday cake

デリカテッセン derikatessen • delicatessen



油
abura
oil

スパイスの利いたソーセージ
supaisu no kita sōsēji
spicy sausage

酢
su
vinegar

生肉
namaniku
uncooked meat

カウンター
kauntā
counter

サラミ
sarami
salami

ペパロニ
peparoni
pepperoni



フラン
furan
flan

パテ
pate
pâté



モツアレチーズ
motsarera chīzu
mozzarella



ブリーチーズ
burī chīzu
brie



山羊チーズ
yagi chīzu
goat cheese



チェダーチーズ
chedā chīzu
cheddar



パルメザンチーズ
parumezan chīzu
parmesan



カマンベールチーズ
kamanbēru chīzu
camembert

皮
kawa
rind



エダムチーズ
edamu chīzu
edam



マンチェゴチーズ
manchego chīzu
manchego



パイ
pai
potpies

黒オリーブ
kuro oribu
black olive

唐辛子
tōgarashi
chili

ソース
sōsu
sauce

ロールパン
rōrupan
bread roll

調理肉
chōri niku
cooked meat

緑オリーブ
midori oribu
green olive



サンドイッチ売場 sandoitchi uriba | sandwich counter

ハム
hamu
ham



魚の薫製
sakana no kunsei
smoked fish



ケーパー
kēpā
capers



プロシュット
puroshutto
prosciutto

チョリソ
choriso
chorizo



スタッフドオリーブ
sutaffudo oribu
stuffed olive

関連用語 kanrenyōgo • vocabulary

油漬け
abura-zuke
in oil

マリネ
marine
marinated

薫製
kunsei
smoked

塩水漬け
shiomizu-zuke
in brine

塩漬け
shiozuke
salted

保存処理
hozon shori
cured

番号札を取ってください。
bangō fuda o totte kudasai.
Take a number please.

それを試食できますか。
sore o shishoku dekimasuka?
May I try some of that please?

それを6切れください。
sore o rokkire kudasai.
Six slices of that, please

飲物 nomimono • drinks

水 mizu • water



暖かい飲物 atataakai nomimono • hot drinks



ソフトドリンク sofuto dorinku • soft drinks



アルコール飲料 arukōru inryō • alcoholic drinks



ジン
jin | gin



ビール
bīru
beer

缶
kan
can



林檎酒
ringoshu
hard cider



ビター
bitā
bitter



黒ビール
kurobīru
stout



ウォッカ
wokka | vodka



ウイスキー uisukī | whisky



ラム酒
ramushu
rum



ブランデー
burandē
brandy



ポートワイン
pōtowain
port



シェリー
sherī
sherry

辛口
karakuchi
dry



カンパリ
kampari
campari

ロゼ(ワイン)
roze (wain)
rosé (wine)

白(ワイン)
shiro (wain)
white (wine)

赤(ワイン)
aka (wain)
red (wine)



リキュール
rikyūru
liqueur



テキーラ
tekīra
tequila



シャンパン
shampan
champagne



ワイン wain | wine





外食 gaishoku
eating out

カフェ kafe • café



メニュー
menyū
menu

オーニング
ōningu
awning

路上カフェ rojō kafe | pavement café



パラソル
parasoru
umbrella

テラスカフェ
terasu kafe
terrace café

ウェイター
weitā
waiter

コーヒーマーカー
kōhī mēkā
coffee machine

テーブル
tēburu
table



スナックバー sunakku bā | snack bar

コーヒー kōhī • coffee



ミルクコーヒー
miruku kōhī
white coffee

ブラックコーヒー
burak kukōhī
black coffee

ココアパウダー
kokoā paudā
cocoa powder

泡
awa
froth

フィルターコーヒー
firutā kōhī
filter coffee

エスプレッソ
esupresso
espresso

カプチーノ
kapuchīno
cappuccino

アイスコーヒー
aisu kōhī
iced coffee

紅茶 kōcha • tea

ハーブ茶
hābu cha
herbal tea



ミルクティー
miruku tī
tea with milk

紅茶
kōcha
black tea



カモミール茶
kamomīru cha
camomile tea



レモンティー
remon tī
tea with lemon



ミントティー
minto tī
mint tea



緑茶
ryokucha
green tea



アイスティー
aisu tī
iced tea

ジュースとミルクセーキ jūsu to mirukusēki • juices and milkshakes



オレンジジュース
orenji jūsu
orange juice



林檎ジュース
ringo jūsu
apple juice



パイナップルジュース
painappuru jūsu
pineapple juice



トマトジュース
tomato jūsu
tomato juice

チョコレートミルクセーキ
chokorēto mirukusēki
chocolate milkshake

苺のミルクセーキ
ichigo no mirukusēki
strawberry milkshake

コーヒーミルクセーキ
kōhī mirukusēki
coffee milkshake



食べ物 tabemono • food

黒パン
kuro pan
brown bread

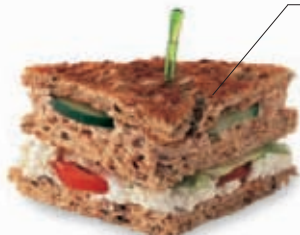

トーストサンド
tōsuto-sando
toasted sandwich



サラダ
sarada
salad



スクープ
sukūpu
scoop

アイスクリーム
aisukurīmu
ice cream



ペストリー
pesutorī
pastry

バー bā • bar



グラス
gurasu
glasses

計量器
keiryōki
dispenser

レジ
reji
cash register

バーテン
bāten
bartender

タップ
tappu
beer tap

コーヒーマーカー
kōhī mēkā
coffee machine

アイスバケツ
aisu baketsu
ice bucket

バースツール
bā sutsūru
bar stool

灰皿
haizara
ashtray

コースター
kōsutā
coaster

カウンター
kauntā
bar counter

栓抜き
sennuki
bottle opener



レバー
rebā
lever

コルク栓抜き koruku sennuki | corkscrew

氷ばさみ
kōri-basami
tongs

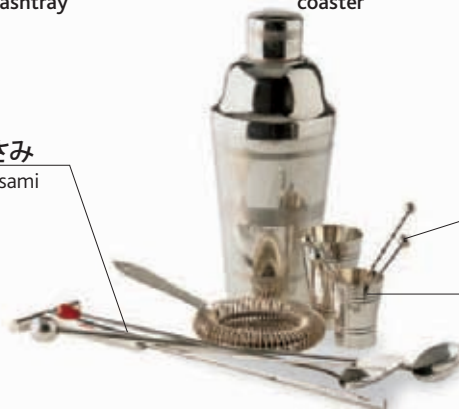

マドラー
madorā
stirrer

メジャーカップ
mejā kappu
measure

シェーカー shēkā
cocktail shaker



ジントニック
jintonikku
gin and tonic

水差し
mizusashi
pitcher



スコッチの水割り
sukotchi no mizuwari
scotch and water



キューバリブレ
kyūba ribure
rum and coke

角氷
kaku-gōri
ice cube



スクリュードライバー
sukuryū doraibā
vodka and orange



マティーニ
matīni
martini



カクテル
kakuteru
cocktail



ワイン
wain
wine



ビール bīru | beer



ワンショット
wanshotto
a shot

シングル
shinguru
single



分量
bunryō
measure

ダブル
daburu
double



氷無し
kōri nashi
without ice

氷とレモン
kōri to remon
ice and lemon



氷入り
kōri-iri
with ice

おつまみ o-tsumami • bar snacks



ポテトチップス poteto chippusu
potato chips

アーモンド
āmondo
almonds

カシューナッツ
kashūnattsu
cashew nuts

ピーナッツ
pīnattsu
peanuts



ナッツ nattsu | nuts



オリーブ oribu | olives

レストラン resutoran • restaurant

禁煙席

kin'en seki
nonsmoking
section

ナプキン

napukin
napkin

コミシェフ

komi shefu
commis chef



キッチン kitchin | kitchen

テーブルセッティング

tēburu settingu
table setting

シェフ

shefu
chef

グラス

gurasu
glass

トレイ

torei
tray



ウェイター weitā | waiter

関連用語 kanrenyōgo • vocabulary

ワインリスト
wain risuto
wine list

デザートワゴン
dezāto wagon
dessert cart

領収書
ryōshūsho
receipt

サービス料抜き
sābisu-ryō nuki
service not included

喫煙席
kitsuen seki
smoking section

胡椒
koshō
pepper

酒
sake
rice wine

値段
nedan
price

チップ
chippu
tip

ビュッフェ
byuffe
buffet

客
kyaku
customer

座卓
zatakō
(low Japanese) table

アラカルト
arakaruto
à la carte

会計
kaikei
check

サービス料込み
sābisu-ryō komi
service included

お薦め料理
o-susume ryōri
specials

塩
shio
salt

座布団
zabutōn
(Japanese) cushion



メニュー
menyū
menu



お子様メニュー
okosama menyū
child's meal



注文する chūmon suru | order (v)



支払う shiharau | pay (v)

コース料理 kōsu ryōri • courses



食前酒
shokuzenshu
aperitif



前菜
zensai
appetizer



スープ
sūpu
soup



主菜
shusai
main course



サイドオーダー
saido ōdā
side order

フォーク
fōku
fork



デザート dezāto
dessert

コーヒースプーン
kōhī supūn
coffee spoon



コーヒー kōhī | coffee

2人分の席をお願いします。
futari-bun no seki o onegaishimasu.
A table for two please.

メニュー/ワインリストを見せてください。
menyū/wainrisuto o misete kudasai?
May I see the menu/winelist please?

セットメニューはありますか。
setto menyū wa arimasuka?
Is there a fixed price menu?

ベジタリアン料理はありますか。
bejitarian ryōri wa arimasuka?
Do you have any vegetarian dishes?

会計/領収書をお願いします。
o-kaikai/ryōshūsho o onegaishimasu?
Could I have the check/a receipt please?

会計は別々にお願いします。
kaikai wa betsubetsu ni onegaishimasu?
Can we pay separately?

お手洗いはどこですか。
o-tearai wa doko desuka?
Where are the restrooms, please?

ファーストフード fāsuto fūdo • fast food

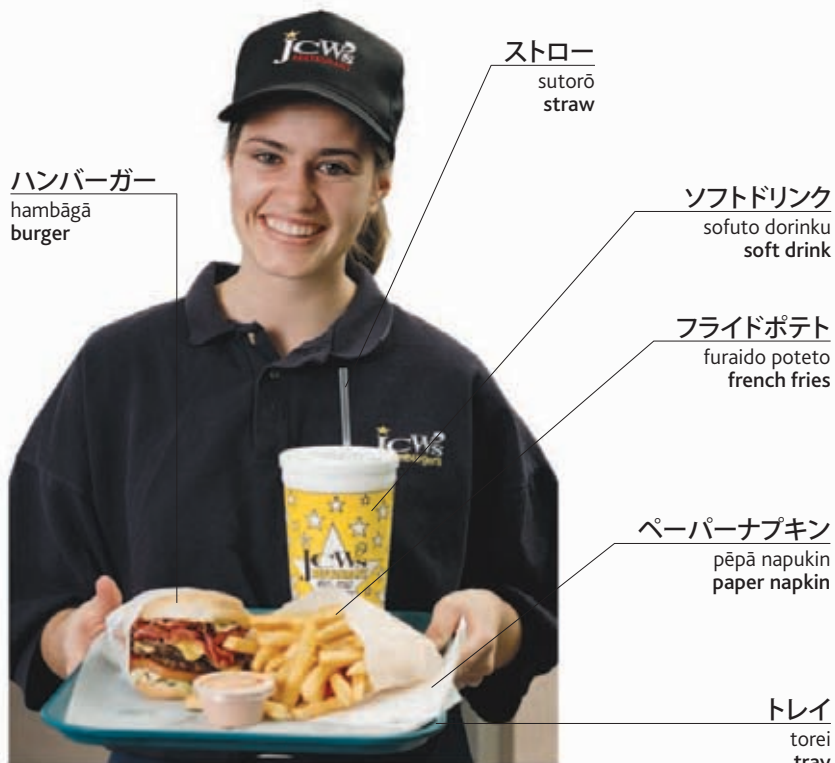

ハンバーガー
hambāgā
burger

ストロー
sutorō
straw

ソフトドリンク
sofuto dorinku
soft drink

フライドポテト
furaido poteto
french fries

ペーパーナプキン
pēpā napukin
paper napkin

トレイ
torei
tray

バーガーミール bāgā mīru | burger meal

ピザ
piza
pizza

価格表
kakaku hyō
price list

缶飲料
kan inryō
canned drink



宅配 takuhai | home delivery



露店 roten | street stand

関連用語 kanrenyōgo • vocabulary

ピザ屋
piza-ya
pizza parlor

ハンバーガー屋
hambāgā-ya
burger bar

メニュー
menyū
menu

店内飲食
tennai inshoku
eat-in

持ち帰り
mochikaeri
takeout

温め直す
atatamaaosu
reheat (v)

ケチャップ
ketchappu
ketchup

おにぎり
onigiri
rice ball

弁当
bentō
lunch box

それを持ち帰りにしてください。
sore o mochikaeri ni shite kudasai?
Can I have that to go, please?

出前はできますか。
demaie wa dekimasuka?
Do you deliver?



ハンバーガー
hambāgā
hamburger



チキンバーガー
chikin bāgā
chicken burger

バンズ
banzu
bun



ベジバーガー
beji bāgā
veggie burger

マスタード
masutādo
mustard

ソーセージ
sōsēji
sausage



ホットドッグ hotto doggu
hot dog



サンドイッチ
sandoitchi
sandwich



クラブサンド
kurabu-sando
club sandwich



オープンサンド
ōpun-sando
open-face sandwich

具
gu
filling



ラップサンド
rappu-sando
wrap



ケバブ
kebabu
kebab

ソース
sōsu
sauce



チキンナゲット
chikin nagetto
chicken nuggets

塩味
shioaji
savory



クレープ kurēpu | crêpes



甘い
amai
sweet

トッピング
toppingu
topping



フィッシュ&チップス
fisshu ando chippusu
fish and chips



スペアリブ
supea ribu
ribs



フライドチキン
furaido chikin
fried chicken



ピザ
pizza
pizza

朝食 chōshoku • breakfast

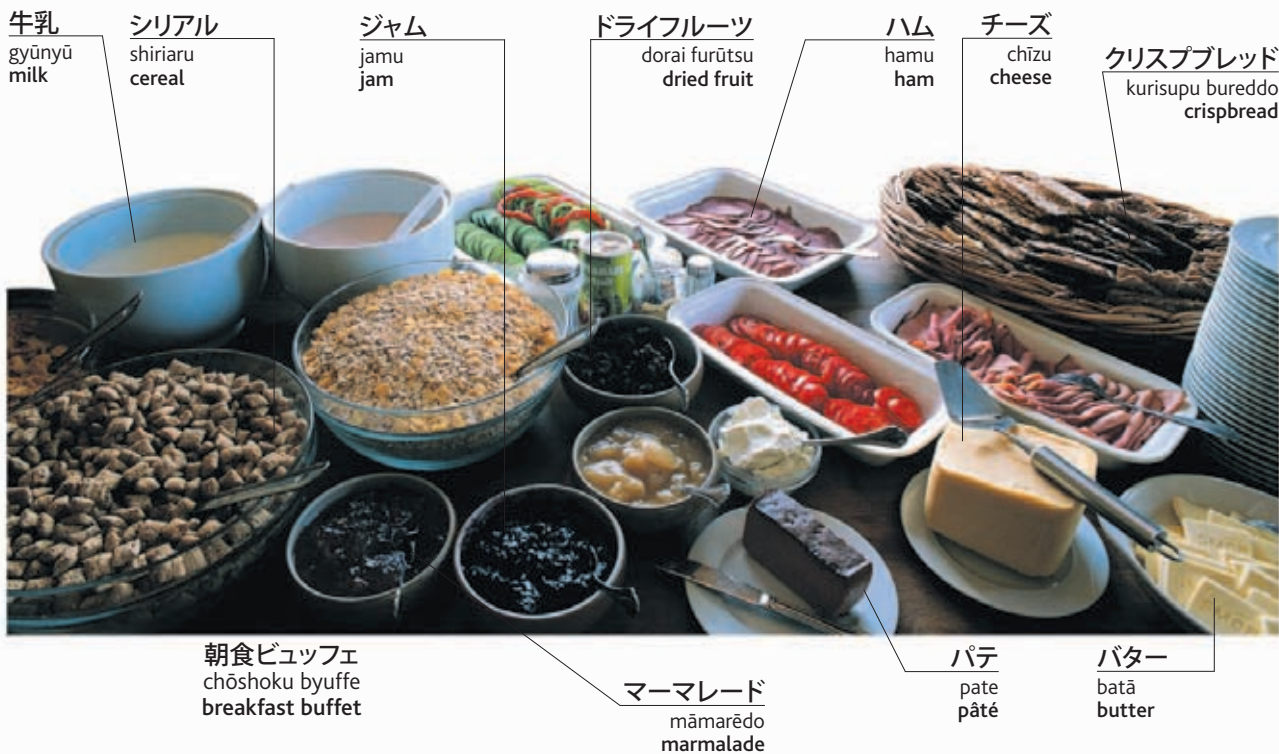

朝食のテーブル chōshoku no tēburu | breakfast table

飲物 nomimono | drinks



ブリオッシュ
buriosshu
brioche



パン
pan
bread

トースト
tōsuto
toast

目玉焼き
medamayaki
fried egg

トマト
tomato
tomato

ブラックプディング
burakku pudingu
black pudding

ソーセージ
sōsēji
sausage

ベーコン
bēkon
bacon

イングリッシュ・ブレイクファースト
ingurisshu burekkufāsuto
English breakfast



薫製ニシン
kunsei nishin
kippers



フレンチトースト
furenchi tōsuto
french toast

黄身
kimi
yolk



ゆで卵
yudetamago
boiled egg



スクランブルエッグ
sukuramburu eggu
scrambled eggs

クリーム
kurīmu
cream



パンケーキ
pankēki
pancakes



ワッフル
waffuru
waffles

フルーツヨーグルト
furūtsu yōguruto
fruit yogurt



ポリッジ
porijji
oatmeal



フルーツサラダ
furūtsu sarada
fruit salad

食事 shokuji • dinner



スープ sūpu | soup



コンソメ konsome | broth



シチュー shichū | stew



カレー karē | curry



ロースト rōsuto | roast



ミートパイ mītopai | potpie



スフレ sufure | soufflé



ケbabu kebabu | kebab



ミートボール mīto bōru
meatballs



オムレツ omuretsu
omelet



焼きそば yaki shoba
fried noodles

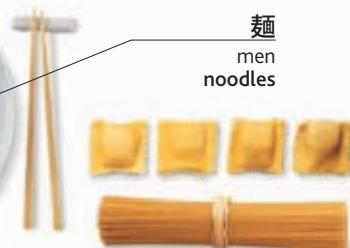

麵
men
noodles

パスタ pasuta
pasta



ご飯 gohan | rice



ミックスサラダ mikkusu sarada
tossed salad



グリーンサラダ gurīn sarada
green salad



サラダドレッシング sarada
doressshingu | dressing

調理方法 chōri hōhō • techniques



詰め物 tsumemono
stuffed



煮込んだ nikonda | in sauce



(グリルで) 焼いた
(guriru de) yaita | grilled



マリネ marine | marinated



(沸騰前の温度で) 茹でた (futto
mae no ondo de) yudeta | poached



つぶした tsubushita
mashed



(オーブンで) 焼いた
(ōbun de) yaita | baked



(フライパンで) 焼いた
(furaipan de) yaita | pan-fried



炒めた itameta | fried



ピクルス pikurusu | pickled



薫製 kunsei | smoked



揚げた ageta | deep-fried



シロップ漬け shiropu-zuke
in syrup



ドレッシングをかけた
doresshingu o kaketa | dressed



蒸した mushita | steamed



保存処理した
hozon shori shita | cured





学習 *gakushū*
study

学校 gakkō • school

先生
sensei
teacher

黒板
kokuban
blackboard



教室 kyōshitsu | classroom



男子生徒 danshi seito
schoolboy

生徒
seito
pupil

学校の制服
gakkō no seifuku
school uniform

机
tsukue
desk

通学鞆
tsūgaku kaban
school bag

チョーク
chōku
chalk



女子生徒
joshi seito
schoolgirl

関連用語 kanrenyōgo • vocabulary

歴史
rekishi
history

科学
kagaku
science

物理
butsuri
physics

外国語
gaikokugo
languages

美術
bijutsu
art

化学
kagaku
chemistry

文学
bungaku
literature

音楽
ongaku
music

生物
seibutsu
biology

地理
chiri
geography

数学
sūgaku
math

体育
tai'iku
physical
education

学業 gakugyō • activities



読む yomu | read (v)



書く kaku | write (v)



綴る tsuzuru | spell (v)



描く egaku | draw (v)



質問する shitsumon suru
question (v)



答える kotaeru | answer (v)



話し合う hanashiau | discuss (v)



学ぶ manabu | learn (v)

関連用語 kanrenyōgo • vocabulary

校長先生
kōchō sensei
principal

答え
kotae
answer

成績
seiseki
grade

授業
jugyō
lesson

宿題
shukudai
homework

学年
gakunen
year

質問
shitsumon
question

試験
shiken
test

辞書
jisho
dictionary

ノートを取る
nōto o toru
take notes (v)

作文
sakubun
essay

百科事典
hyakkajiten
encyclopedia

数学 sūgaku • math

平面図形 heimenzukei • shapes

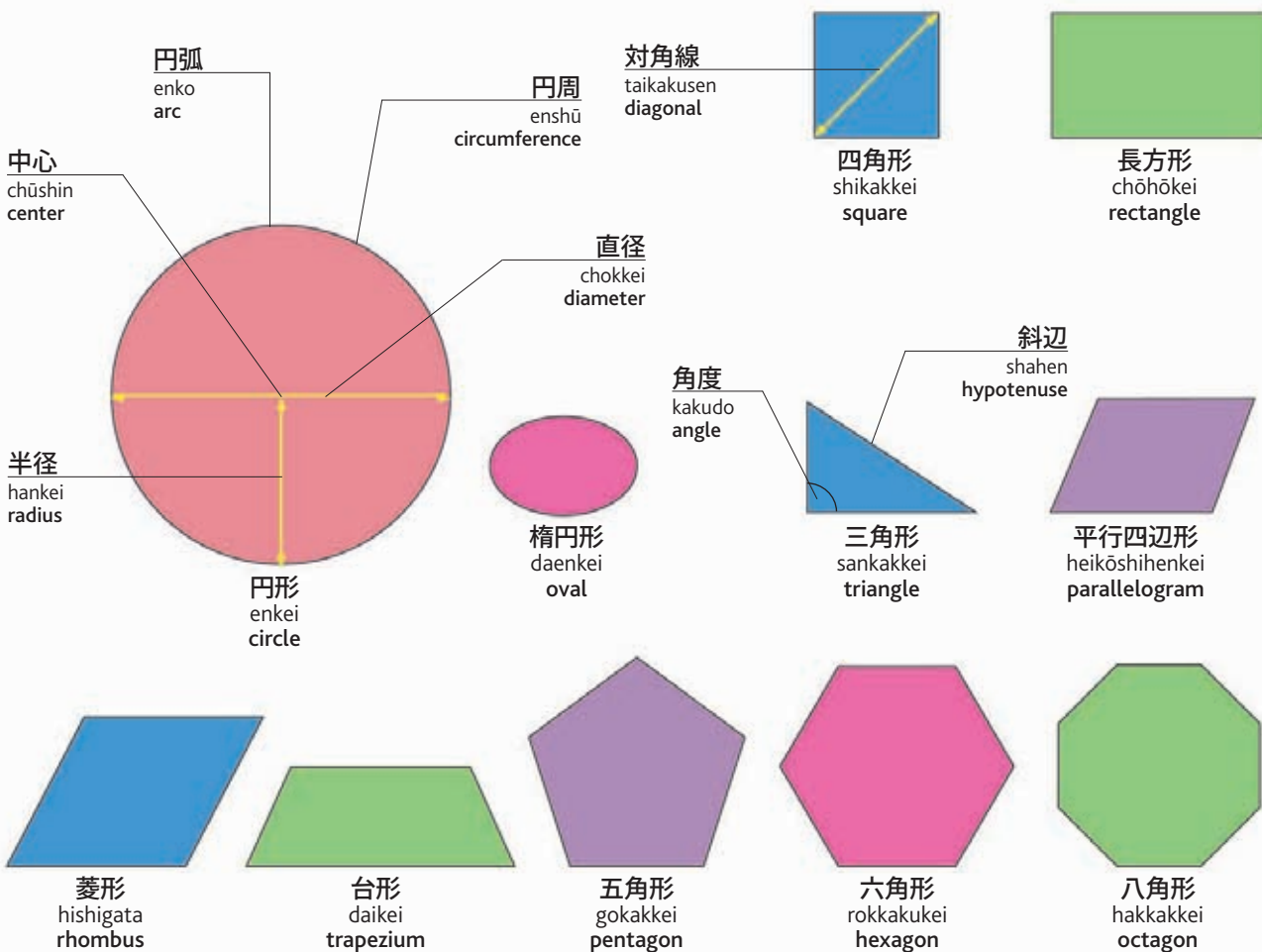

立体図形 rittaizukei • solids

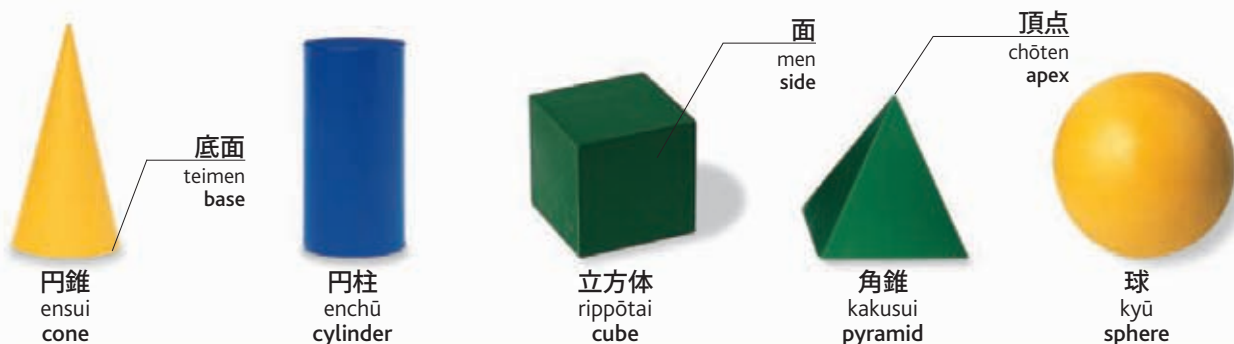

線 sen • lines



直線
chokusen
straight



平行線
heikōsen
parallel



垂直線
suichokusen
perpendicular



曲線
kyokusen
curved

測定 sokutei • measurements



体積
taiseki
volume

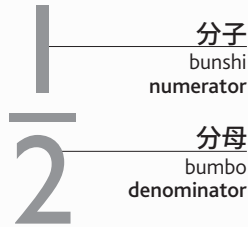

分数
bunsū
fraction



寸法
sumpō
dimensions

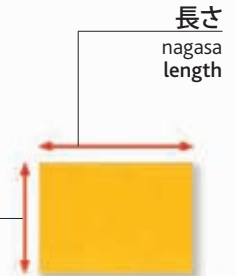

面積
menseki
area

数学用品 sūgaku yōhin • equipment



三角定規
sankakujōgi
set square



分度器
bundoki
protractor



定規
jōgi
ruler



コンパス
kompasu
compass



電卓
dentaku
calculator

関連用語 kanrenyōgo • vocabulary

幾何学
kikagaku
geometry

プラス
plusu
plus

掛ける
kakeru
times

イコール
ikōru
equals

足す
tasu
add (v)

掛ける
kakeru
multiply (v)

数式
sūshiki
equation

算数
sansū
arithmetic

マイナス
mainasu
minus

割る
waru
divided by

数える
kazoeru
count (v)

引く
hiku
subtract (v)

割る
waru
divide (v)

百分率
hyakubunritsu
percentage

科学 kagaku • science



実験室
jikken shitsu
laboratory

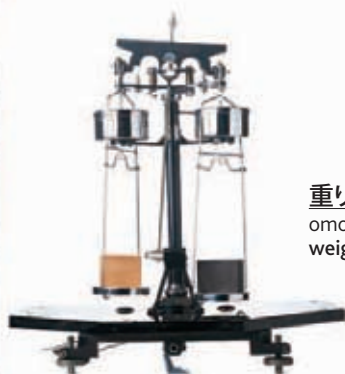

天秤
tembin
scale

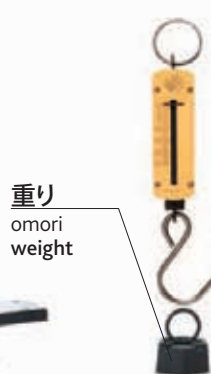

重り
omori
weight

バネ秤
banebakari
spring balance

坩堝
rutsubo
crucible



ブンゼンバーナー
bunzen bānā
bunsen burner

三脚
sankyaku
tripod



ガラス瓶
garasu bin
glass bottle

漏斗
rōto
funnel

フラスコ
furasuko
flask



スタンド
sutando
clamp stand

クランプ
kurampu
clamp

ストッパー
sutoppā
stopper

実験 jikken | experiment

試験管
shikenkan
test tube



試験管立て
shikenkan-tate
rack



タイマー
taimā
timer



シャーレー
shārē
petri dish



温度計
ondokei
thermometer

注射器
chūshaki
syringe

ピンセット
pinsetto
tweezers

メス
mesu
scalpel



スポイト supoito | dropper



鉗子 kanshi | forceps



トング tongu | tongs



へら hera | spatula

乳棒
nyūbō
pestle



乳鉢
nyūbachi
mortar



濾紙
roshi
filter paper



安全ゴーグル
anzen gōguru
safety goggles

接眼レンズ
setsugan renzu
eyepiece

焦点調節ノブ
shōten chōsetsu nobu
focusing knob



対物レンズ
taibutsu renzu
objective lens

試料台
shiryō dai
stage

スライド
suraido
slide

反射鏡
hanshakyō
mirror

顕微鏡 kembikyō | microscope



ガラス棒
garasubō
glass stirring rod



ビーカー
bikā
beaker

ピペット
pipetto
pipette



磁石
jishaku
magnet



鱷口クリップ
waniguchi kurippu
crocodile clip

負極
fukyoku
negative electrode



電池 denchi | battery

正極
seikyoku
positive electrode

大学 daigaku • college

スポーツフィールド

supōtsu firudo
playing field

入学事務局

nyūgaku
jimukyoku
admissions

学生食堂

gakusei shokudō
refectory

医療センター

iryō sentā
health center

学生寮

gakusei ryō
residence hall

図書目録

toshō mōkuroku
card catalog



キャンパス kyampusu | campus

司書

shisho
librarian

貸出カウンター

kashidashi kauntā
circulation desk

書架

shoka
bookshelf

定期刊行物

teiki kankōbutsu
periodical

雑誌

zasshi
journal



図書館 toshokan | library

関連用語 kanrenyōgo • vocabulary

図書カード

toshō kādo
library card

問い合わせ

toiawase
help desk

借出し

karidashi
loan

閲覧室

etsuran shitsu
reading room

借りる

kariru
borrow (v)

本

hon
book

読書リスト

dokusho risuto
reading list

予約する

yoyaku suru
reserve (v)

題名

daimēi
title

返却日

henkyaku-bi
return date

延長する

enchō suru
renew (v)

通路

tsūro
aisle

大学生
daigakusei
undergraduate

講師
kōshi
lecturer



講堂 kōdō | lecture hall

卒業生
sotsugyōsei
graduate

ローブ
rōbu
robe



卒業式 sotsugyō-shiki | graduation ceremony

専門学校 senmongakkō • schools



モデル
moderu
model

美術大学 bijutsu daigaku
art college



音楽学校 ongaku gakkō
music school



舞踊学院 buyō gakuin
dance academy

関連用語 kanrenyōgo • vocabulary

奨学金
shōgakuin
scholarship

研究
kenkyū
research

学位論文
gakui-rombun
dissertation

医学
igaku
medicine

哲学
tetsugaku
philosophy

卒業証書
sotsugyō-shōsho
diploma

修士号
shūshi gō
master's

学部
gakubu
department

動物学
dōbutsugaku
zoology

文学
bungaku
literature

学位
gakui
degree

博士号
hakase gō
doctorate

法学
hōgaku
law

物理学
butsurigaku
physics

美術史
bijutsushi
art history

大学院
daigakuin
postgraduate

卒業論文
sotsugyō-rombun
thesis

工学
kōgaku
engineering

政治学
seijigaku
politics

経済学
keizaigaku
economics

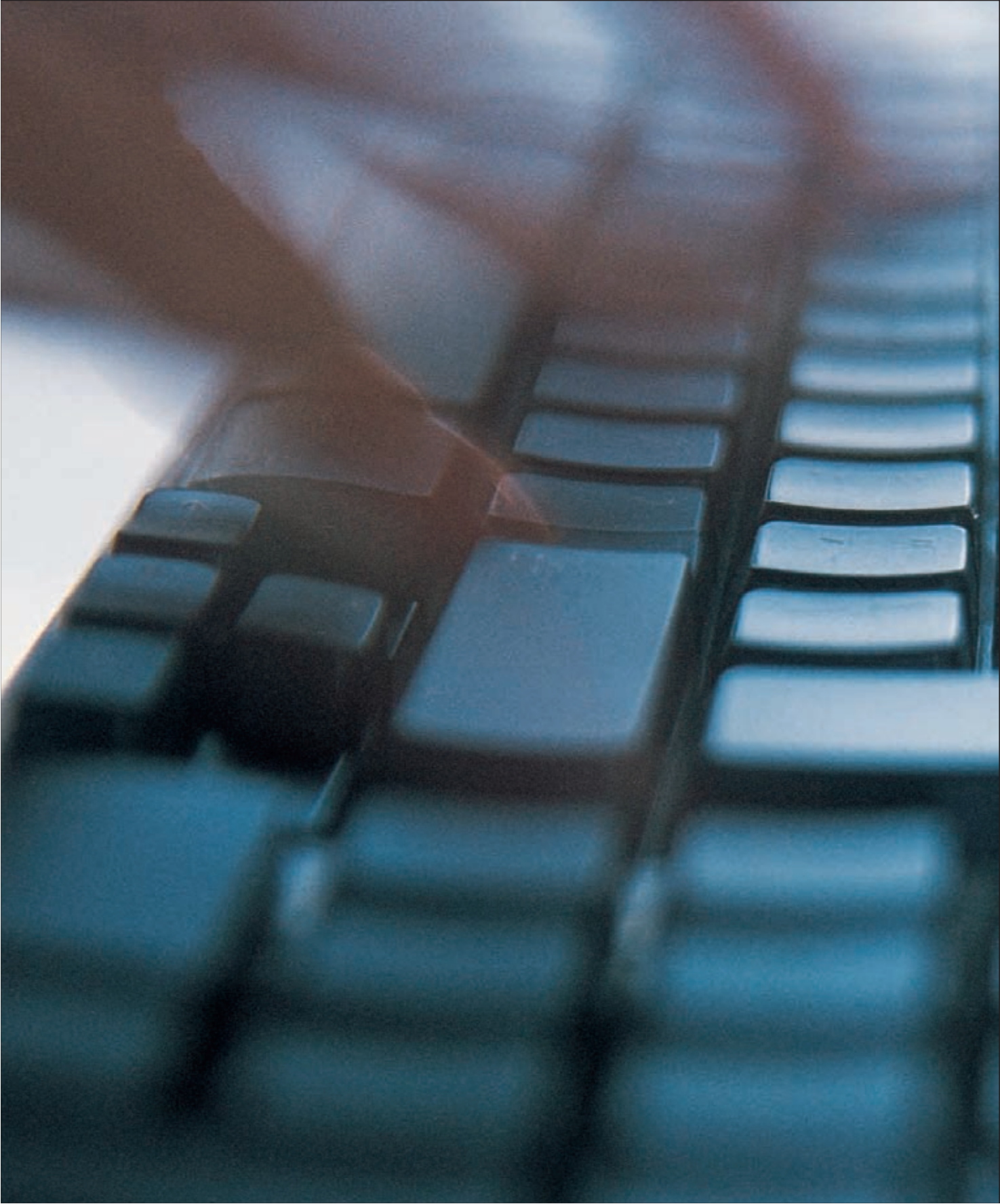

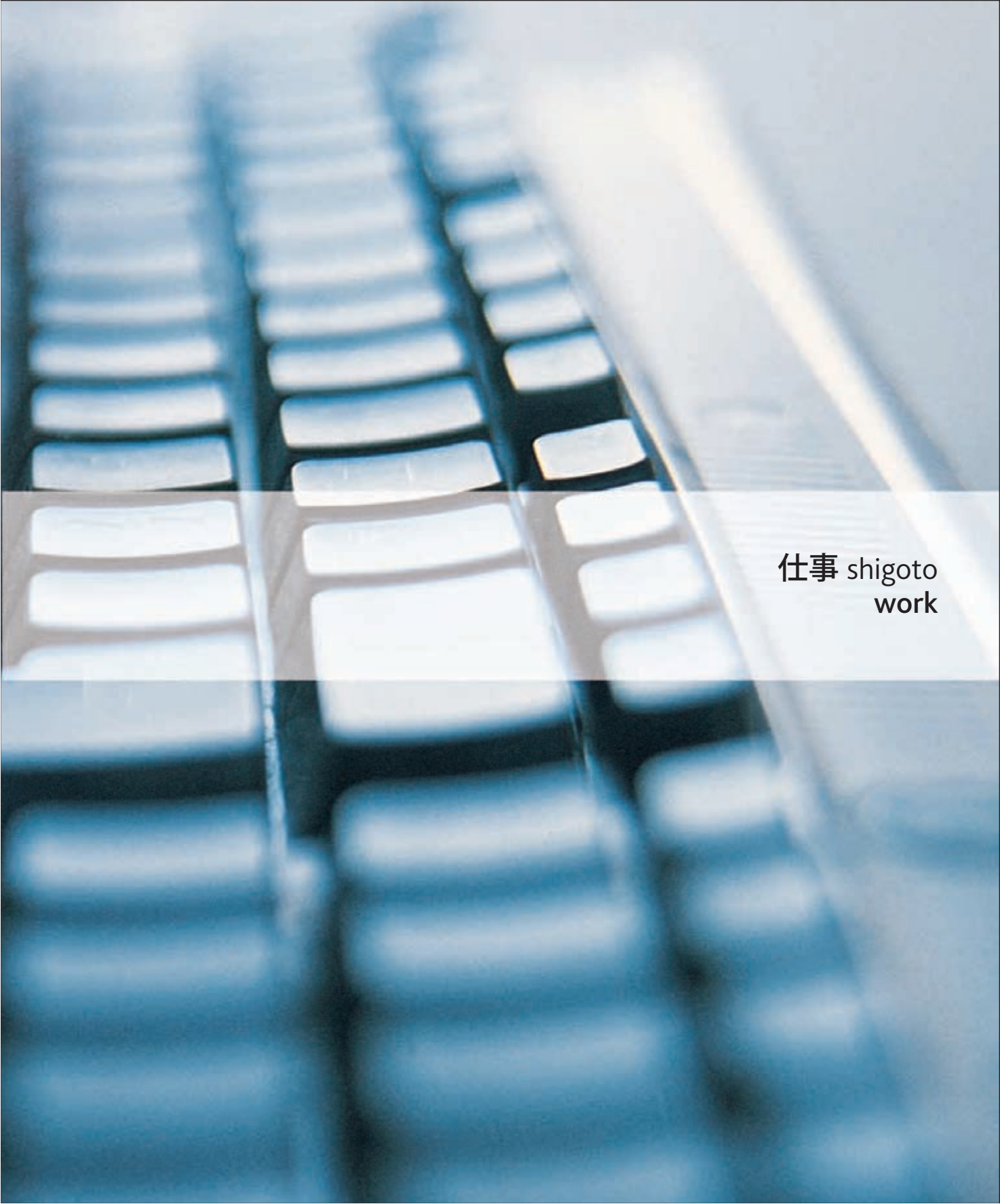

仕事 shigoto
work

事務所1 jimusho • office 1

事務所 jimusho • office



事務機器 jimū kiki • office equipment

給紙トレイ kyūshi torei paper tray



プリンタ purinta | printer

用紙ガイド yōshi gaido paper guide



ファックス fakkusu | fax machine

ファックス fakkusu fax

関連用語 kanrenyōgo • vocabulary

印刷する insatsu suru print (v)

拡大する kakudai suru enlarge (v)

複写する fukusha suru copy (v)

縮小する shukushō suru reduce (v)

コピーを取らなければなりません。
kopī o toranakereba narimasen.
I need to make some copies.

事務用品 jimū yōhin • office supplies



謹呈スリップ
kintei surippu
notecard

レターヘッド
retāheddo
letterhead



封筒
fūtō
envelope

箱型ファイル
hako-gata fairu
file box



仕切りカード
shikiri kādo
divider



クリップボード
kurippubōdo
clipboard



ノート
nōto
notepad



インデックス
indekkusu
tab

吊り下げ式フォルダー
tsurisage-shiki forudā
hanging file

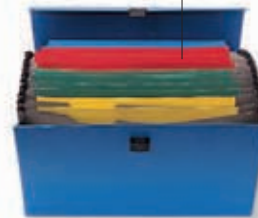

ドキュメントファイル
dokyumento fairu
accordion file

レバーアーチ式ファイル
rebā'āchi-shiki fairu
binder



システム手帳
shisutemu techō
personal organizer

(ホチキスの) 針
(hochikisu no) shin
staples



ホチキス
hochikisu
stapler

セロテープ
serotēpu
sticky tape

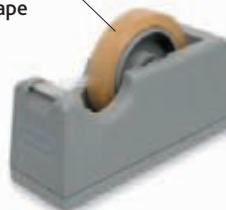

テープカッター
tēpu kattā
tape dispenser



穴あけパンチ
ana'ake panchi
hole punch

スタンプ台
sutampu dai
ink pad



ゴム印
gomuin
rubber stamp



輪ゴム
wagomu
rubber band



目玉クリップ
medama kurippu
bulldog clip



ゼムクリップ
zemu kurippu
paper clip

画鋏
gabyō
push pin



掲示板 keijiban | bulletin board

事務所2 jimusho • office 2

フリップチャート
furippu chāto
flipchart

議事録
gijiroku
minutes

イーゼル
izeru
easel

報告書
hōkokusho
report

マネージャー
manējā
manager

提案書
teian sho
proposal

幹部
kambu
executive



会議 kaigi | meeting

関連用語 kanrenyōgo • vocabulary

会議室
kaigi shitsu
meeting room

出席する
shusseki suru
attend (v)

議題
gidai
agenda

議長を務める
gichō o tsutomeru
chair (v)

会議は何時ですか。
kaigi wa nanji desuka?
What time is the meeting?

営業時間は何時から何時までですか。
eigyōjikan wa nanji kara nanji made desuka?
What are your office hours?

プレゼンター
purezentā
speaker

プロジェクター
purojekutā
projector



プレゼンテーション purezentēshon | presentation

ビジネス bijinesu • business

ノートパソコン
nōtopasokon
laptop

メモ
memo
notes

ビジネスマン
bijinesuman
businessman

ビジネスウーマン
bijinesu'ūman
businesswoman



ビジネスランチ bijinesu ranchi | business lunch



出張 shutchō | business trip



手帳 techō | diary

取引先
torihikisaki
client

予定
yotei
appointment

電子手帳
denshitechō
electronic diary



社長
shachō
CEO

商取引 shōtorihiki | business deal

関連用語 kanrenyōgo • vocabulary

会社
kaisha
company

従業員
jūgyōin
staff

経理部
keiri bu
accounts department

法務部
hōmu bu
legal department

本社
honsha
headquarters

給料
kyūryō
salary

市場開発部
shijōkaihatsu bu
marketing department

顧客サービス部
kōkyaku sābisu bu
customer service department

支社
shisha
regional office

従業員名簿
jūgyōin meibo
payroll

営業部
eigyō bu
sales department

人事部
jinji bu
human resources department

コンピュータ kompyūta • computer

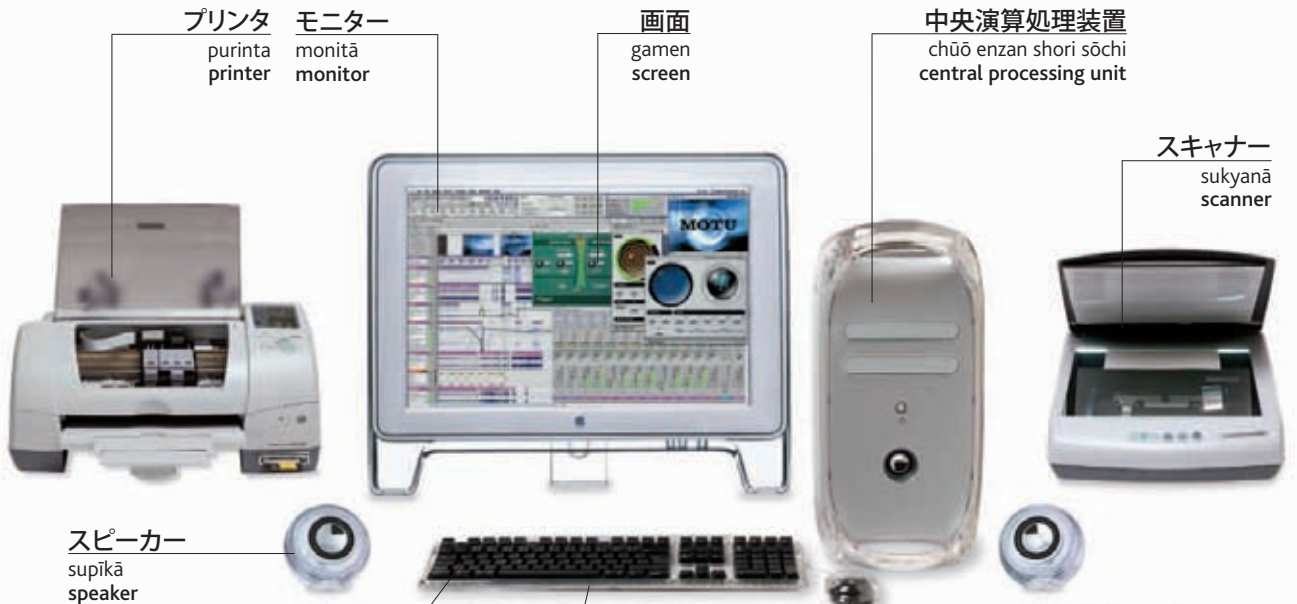

ハードウェア hādowea hardware



関連用語 kanrenyōgo • vocabulary

メモリ memori memory	ソフト sofuto software	サーバー sābā server
RAM ramu RAM	アプリケーション apurikēshon application	ポート pōto port
バイト baito bytes	プログラム puroguramu program	プロセッサ purosesa processor
システム shisutemu system	ネットワーク nettowāku network	電源ケーブル dengen kēburu power cable

デスクトップ desukutoppu • desktop

メニューバー
menyūbā
menubar

ツールバー
tsūrubā
toolbar

壁紙
kabegami
wallpaper

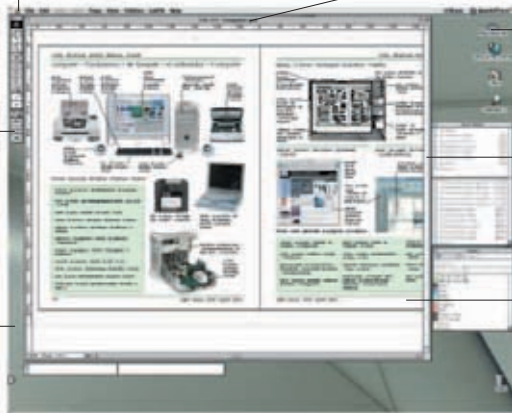

フォント
fonto
font

アイコン
aikon
icon

スクロールバー
sukurōrubā
scrollbar

ウィンドウ
windo-u
window



ファイル
fairu
file

フォルダ
foruda
folder

ごみ箱
gomibako
trash

インターネット intānetto • internet

電子メール denshimēru • email



ブラウザ
burauza
browser

受信箱
jushin-bako
inbox

ウェブサイト
webusaito
website

メールアドレス
mēru adoresu
email address

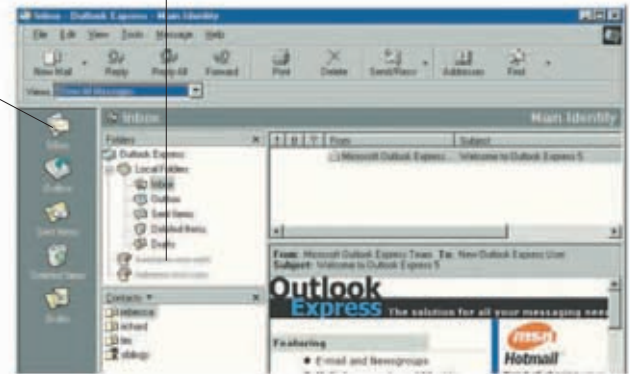

閲覧する etsuran suru | browse (v)

関連用語 kanrenyōgo • vocabulary

接続する
setsuzoku suru
connect (v)

サービスプロバイダ
sābisu purobaida
service provider

ログオンする
roguon suru
log on (v)

ダウンロードする
daunrōdo suru
download (v)

送信する
sōshin suru
send (v)

保存する
hozon suru
save (v)

インストールする
insutōru suru
install (v)

メールアドレス
mēru akaunto
email account

オンライン
onrain
online

添付書類
tempu shorui
attachment

受信する
jushin suru
receive (v)

検索する
kensaku suru
search (v)

報道 hōdō • media

テレビスタジオ terebi sutajio • television studio

司会者
shikai-sha
presenter

照明
shōmei
light

セット
setto
set



カメラ
kamera
camera

カメラ台
kamera dai
camera crane

カメラマン
kameraman
cameraman

関連用語 kanrenyōgo • vocabulary

チャンネル
channeru
channel

ニュース
nyūsu
news

新聞
shimbun
press

連続ドラマ
renzoku dorama
soap

アニメ
anime
cartoon

ライブ
raibu
live

番組制作
bangumi seisaku
programming

ドキュメンタリー
dokyumentarī
documentary

シリーズ番組
shirīzu bangumi
television series

ゲーム番組
gēmu bangumi
game show

録画
rokuga
prerecorded

放送する
hōsō suru
broadcast (v)



インタビュアー intabyuā | interviewer



レポーター repōtā | reporter



テロップ teroppu | teleprompter



ニュースキャスター nyūsukyasutā | news anchor



俳優 haiyū | actors



ブームマイク būmumaiku | sound boom



カチンコ kachinko | clapper board



映画のセット eiga no setto | film set

ラジオ rajio • radio

調整卓
chōsei taku
mixing desk

マイク
maiku
microphone

サウンドエンジニア
saundo enjinia
sound technician



録音スタジオ rokuon sutajio | recording studio

関連用語 kanrenyōgo • vocabulary

ラジオ局
rajio kyoku
radio station

中波
chūha
medium wave

放送
hōsō
broadcast

周波数
shūhasū
frequency

波長
hachō
wavelength

音量
onryō
volume

長波
chōha
long wave

合わせる
awaseru
tune (v)

短波
tampa
short wave

ディスクジョッキー
disuku jocki
DJ

法律 hōritsu • law

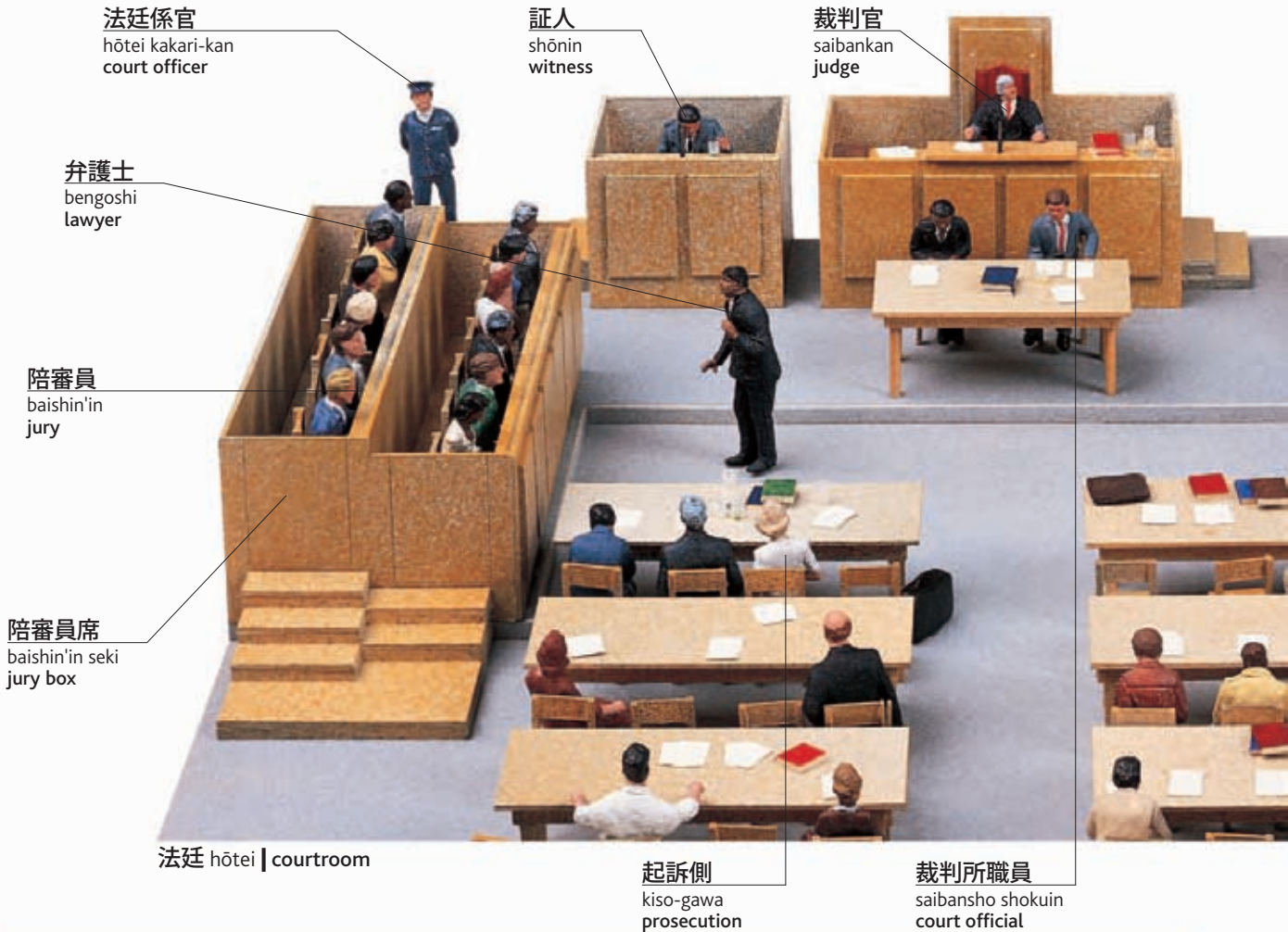

関連用語 kanrenyōgo • vocabulary

法律事務所
hōritsu jimusho
lawyer's office

呼出し状
yobidashijō
summons

命令
meirei
writ

訴訟案件
soshō anken
court case

法律相談
hōritsu sōdan
legal advice

陳述書
chinjutsu-sho
statement

公判日
kōhan-bi
court date

罪状
zaijō
charge

クライアント
kuraianto
client

令状
reijō
warrant

罪状認否
zaijōnimpi
plea

被疑者
higisha
accused

速記者
sokki-sha
stenographer



容疑者
yōgisha
suspect



モンタージュ写真 montāju
shashin | composite

犯罪者
hanzai-sha
criminal



犯罪歴 hanzai-reki
criminal record

被告人
hikokunin
defendant

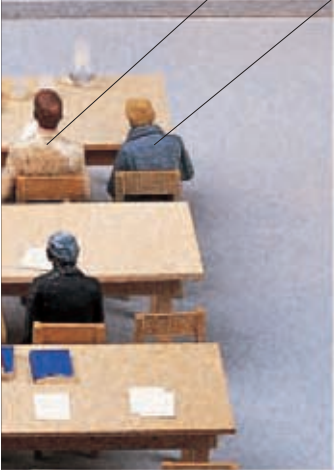

被告側
hikoku-gawa
defense



看守 kanshu | prison guard



監房 kambō | cell



刑務所 keimusho | prison

関連用語 kanrenyōgo • vocabulary

証拠
shōko
evidence

有罪
yūzai
guilty

保釈金
hoshakukin
bail

弁護士に会わせてください。
bengoshi ni awasete kudasai
I want to see a lawyer.

判決
hanketsu
verdict

無罪
muzai
acquitted

上訴
jōso
appeal

裁判所はどこですか。
saibansho wa doko desuka?
Where is the courthouse?

無実
mujitsu
innocent

刑罰
keibatsu
sentence

仮釈放
karishakuho
parole

保釈金を払えますか。
hoshakukin o haraemasuka?
Can I post bail?

農場1 nōjō • farm 1



農夫
nōfu
farmer

菜園
saien
vegetable garden

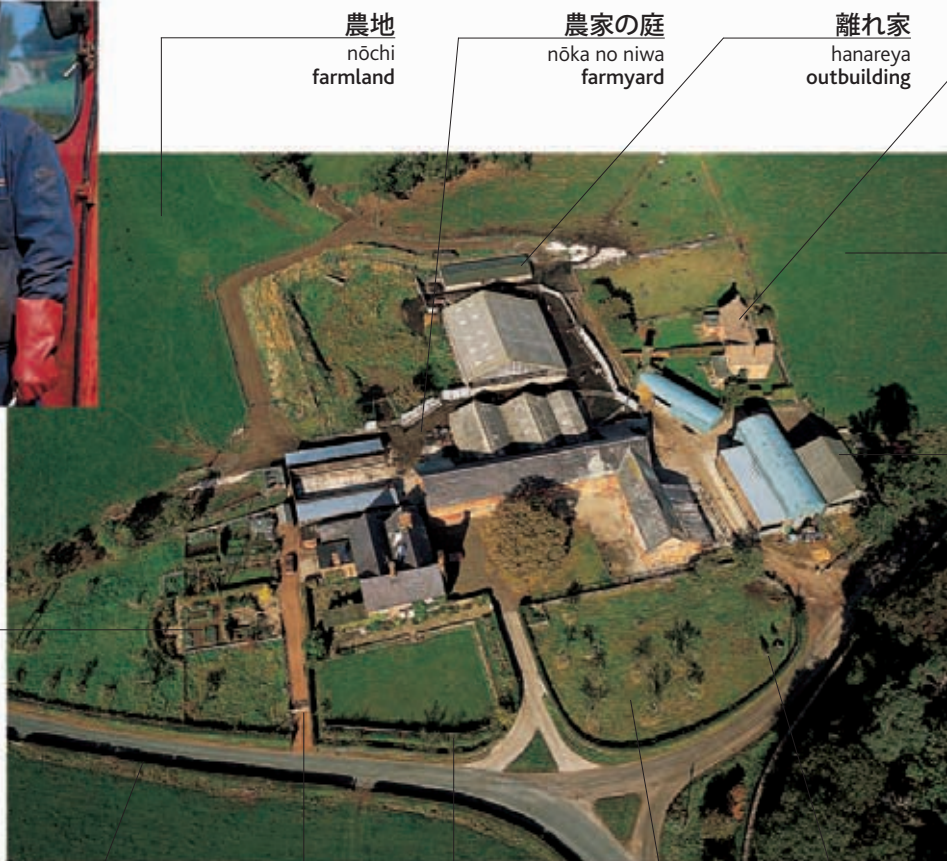

トラクター torakutā | tractor



耕運機
kō'unki
cultivator

コンバイン kombain | combine

農場の種類 nōjō no shurui • types of farm

作物
sakumotsu
crop



耕作農場
kōsaku nōjō
crop farm



酪農場
rakunōjō
dairy farm

羊の群れ
hitsuji no mure
flock



牧羊農場
bokuyō nōjō
sheep farm



養鶏場 yōkeijō
poultry farm

葡萄の木
budō no ki
vine



葡萄園
budōen
vineyard



養豚場
yōtonjō
pig farm



養魚場
yōgyojō
fish farm



果樹園
kajuen
fruit farm

業務 gyōmu • actions

畦
aze
furrow



耕す
tagayasu
plow (v)



種を蒔く
tane o maku
sow (v)



乳を搾る
chichi o shiboru
milk (v)

餌を与える
esa o ataeru
feed (v)



水を引く mizu o hiku
water (v)



刈り入れる kari'ireru
harvest (v)

関連用語 kanrenyōgo • vocabulary

除草剤
josōzai
herbicide

群れ
mure
herd

かえば桶
kaibaoke
trough

殺虫剤
satchūzai
pesticide

サイロ
sairo
silo

植える
ueru
plant (v)

農場2 nōjō • farm 2

作物 sakumotsu • crops



小麦
komugi
wheat



トウモロコシ
tōmorokoshi
corn



大麦
ōmugi
barley



菜種
natane
rapeseed



向日葵
himawari
sunflower



俵
tawara
bale

干し草
hoshikusa
hay



アルファルファ
arufarufa
alfalfa



煙草
tabako
tobacco



米
kome
rice



茶
cha
tea



コーヒー
kōhī
coffee



かかし
kakashi
scarecrow



亜麻
ama
flax



砂糖黍
satōkibi
sugarcane



綿花
menka
cotton

家畜 kachiku • livestock

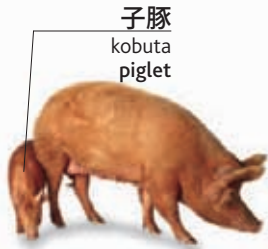

子豚
kobuta
piglet

豚
buta
pig



子牛
ko-ushi
calf

雌牛
meushi
cow



雄牛
o-ushi
bull



羊
hitsuji
sheep



子羊
kohitsuji
lamb



子山羊
koyagi
kid

山羊
yagi
goat

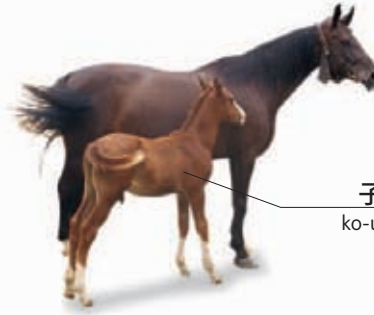

子馬
ko-uma
foal

馬
uma
horse



驢馬
roba
donkey

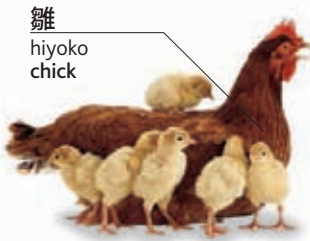

雛
hiyoko
chick

鶏
niwatori
chicken



雄鶏
ondori
cockerel



七面鳥
shichimenchō
turkey



子鴨
kogamo
duckling

鴨
kamo
duck



馬屋
umaya
stable



畜舎
chikusha
pen



鳥小屋
torigoya
chicken coop



豚小屋
butagoya
pigsty

建設 kensetsu • construction

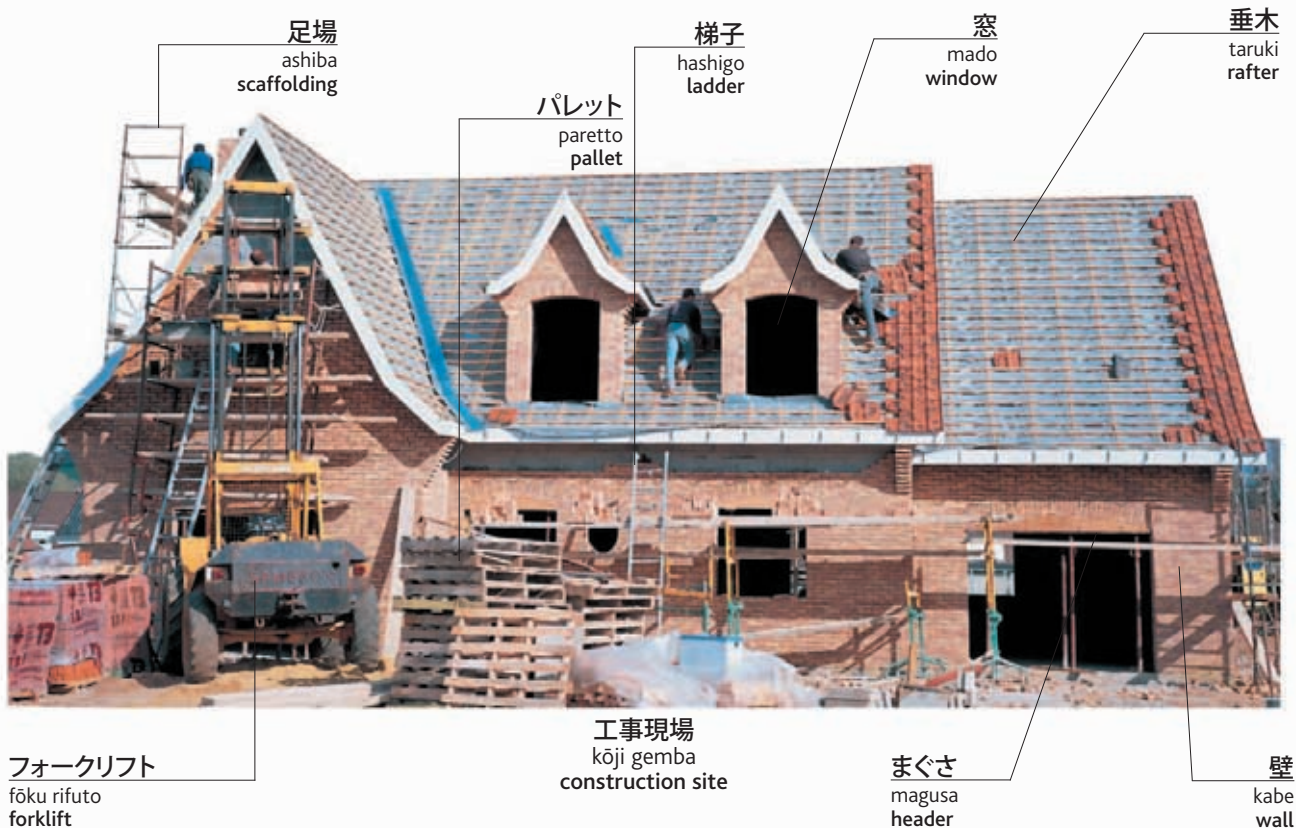

建築材料 kenchiku zairyō • materials



煉瓦
renga
brick



材木
zaimoku
lumber



屋根瓦
yane-gawara
roof tile



コンクリートブロック
konkurīto burokku
concrete block

道具 dōgu • tools

モルタル
morutaru
mortar



こて
kote
trowel



水平器
suiheiki
level



大ハンマー
ōhanmā
sledgehammer

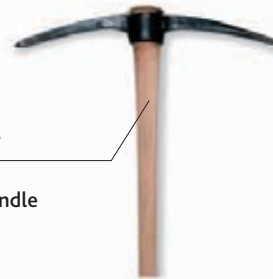

つるはし
tsuruhashi
pickax



スコップ
sukoppu
shovel

柄
e
handle

機械 kikai • machinery



ローラー
rōrā
roller



ダンプカー
dampukā
dump truck



フック
fukku
hook

クレーン車 kurēn-sha | crane

アウトリガー
autorigā
support

道路工事 dōro kōji • roadwork

タールマック
tārumakku
asphalt

三角コーン
sankaku-kōn
cone



空気ドリル
kūki-doriru
pneumatic drill



再舗装
saihosō
resurfacing

掘削機
kussakuki
excavator

職業1 shokugyō • occupations 1



大工
daiku
carpenter



電気工
denkikō
electrician



配管工
haikankō
plumber



建築屋
kenchiku-ya
construction worker



庭師
niwashi
gardener

掃除機
sōjiki
vacuum
cleaner



掃除夫
sōjifu
cleaner



修理工
shūrikō
mechanic



肉屋
nikuya
butcher

鉋
hasami
scissors

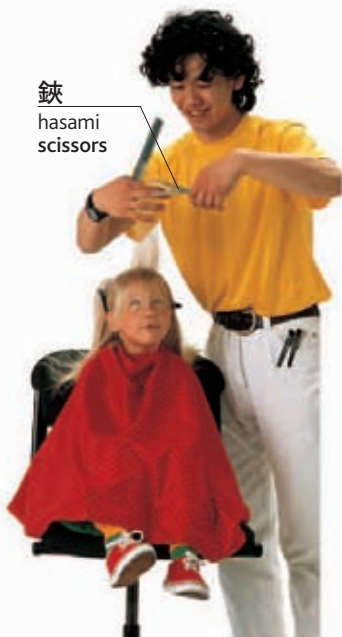

美容師
biyōshi
hair stylist



魚屋
sakanaya
fishmonger



八百屋
yaoya
greengrocer



花屋
hanaya
florist



床屋
tokoya
barber



宝石商
hōseki-shō
jeweler



店員
ten'in
shop clerk



不動産屋
fudōsan-ya
real estate agent



眼鏡屋
megane-ya
optician



歯医者
haisha
dentist

マスク
masuku
mask



医者
isha
doctor



薬剤師
yakuzaishi
pharmacist



看護婦
kangofu
nurse



獣医
jūi
veterinarian



農夫
nōfu
farmer



漁師
ryōshi
fisherman

マシンガン
mashin-gan
machine gun



兵士
heishi
soldier



警官
keikan
policeman

名札
nafuda
identity badge



警備員
keibi'in
security guard

制服
seifuku
uniform



船員
sen'in
sailor



消防士
shōbōshi
firefighter

職業2 shokugyō • occupations 2



弁護士
bengoshi
lawyer



会計士
kaikeishi
accountant



建築家 kenchikuka | architect

模型
mokei
model



科学者
kagakusha
scientist



教師
kyōshi
teacher



司書
shisho
librarian



受付係
uketsuke gakari
receptionist



郵便鞆
yūbin kaban
mailbag

郵便配達
yūbinhaitatsu
mail carrier



バスの運転手
basu no untenshu
bus driver



トラックの運転手
torakku no untenshu
truck driver



タクシーの運転手
takushī no untenshu
taxi driver



パイロット
pairotto
pilot



スチュワーデス
suchuwādesu
air stewardess



旅行代理店の社員
ryokō dairiten no shain
travel agent

シェフの帽子
shefu no bōsh
chef's hat



シェフ
shefu
chef



チュチュ
chuchu
tutu

音楽家
ongakuka
musician



ダンサー
dansā
dancer



俳優
haiyū
actor



歌手
kashu
singer



ウェイトレス
weitoresu
waitress



バーテン
bāten
bartender



スポーツマン
supōtsuman
athlete



彫刻家
chōkokuka
sculptor



画家
gaka
painter



写真家
shashinka
photographer



ニュースキャスター
nyūskyasutā
news anchor



メモ
memo
notes

ジャーナリスト
jānarisuto
journalist

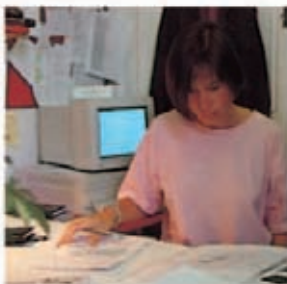

編集者
henshū-sha
editor



デザイナー
dezainā
designer



針子
hariko
seamstress



仕立屋
shitateya
tailor





交通 kōtsū
transportation

道路 dōro • roads

高速道路
kōsoku dōro
highway

料金所
ryōkin-jo
toll booth

路面標識
romen hyōshiki
road markings

出入路
shutsunyū-ro
on-ramp

一方通行
ippōt-sūkō
one-way

分岐帯
bunki-tai
divider

ジャンクション
jankushon
junction

信号
shingō
traffic light

トラック
torakku
truck

中央分離帯
chūō bunri-tai
median

走行車線
sōkō shasen
inside lane

中央車線
chūō shasen
middle lane

追い越し車線
oikoshi shasen
outside lane

出口ランプ
deguchi rampu
exit ramp

交通
kōtsū
traffic

高架道路
kōka dōro
overpass

路肩
rokata
hard shoulder

ガード下通路
gādo shita tsūro
underpass



横断歩道
ōdan hodō
pedestrian crossing



緊急電話
kinkyū denwa
emergency phone



身体障害者用駐車スペース
shintai shōgaisha-yō
chūsha supēsu
disabled parking



交通渋滞
kōtsū jūtai
traffic jam

地図
chizu
map



パーキングメーター
pākingu mētā
parking meter



交通巡査
kōtsū jūsa
traffic police officer

関連用語 kanrenyōgo • vocabulary

環状交差点
kanjō kōsaten
traffic circle

往復分離道路
ōfuku bunri dōro
divided highway

追い越す
oikosu
pass (v)

迂回路
ukairo
diversion

駐車する
chūsha suru
park (v)

レッカー移動
rekka idō
tow away (v)

道路工事
dōro kōji
roadwork

運転する
unten suru
drive (v)

これは...へ行く道ですか。
kore wa ... e iku
michi desuka?
Is this the road to...?

ガードレール
gādo rēru
crash barrier

バックする
baku suru
back up (v)

どこに駐車できますか。
dokoni chūsha dekimasuka?
Where can I park?

道路標識 dōro hyōshiki • road signs



進入禁止
shinnyū kinshi
do not enter



制限速度
seigen sokudo
speed limit



危険
kiken
hazard



停車禁止
teisha kinshi
no stopping



右折禁止
jusetsu kinshi
no right turn

バス basu • bus

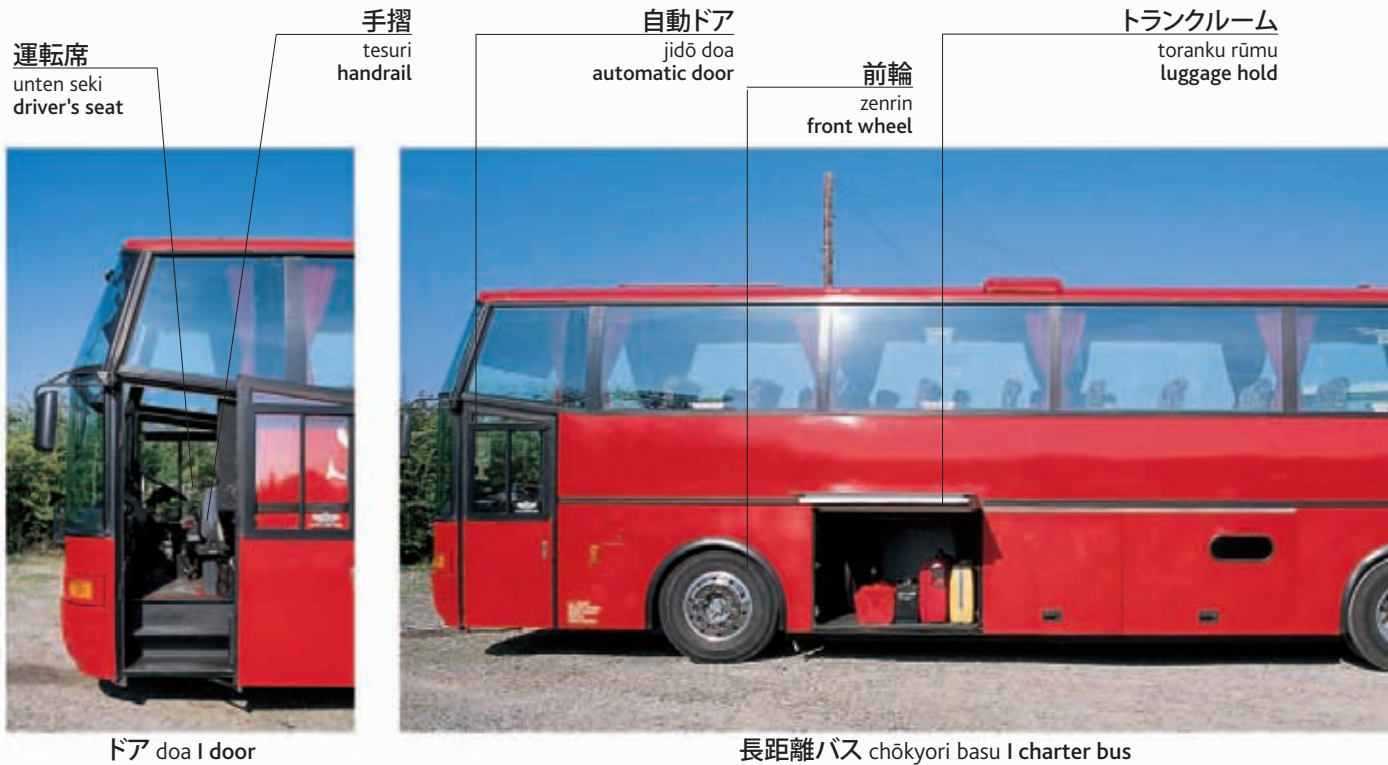

バスの種類 basu no shurui • types of buses



後輪
kōrin
rear wheel

窓
mado
window

停車ボタン
teisha botan
stop button



ベル
beru
bell



バスターミナル
basu tāminaru
bus station



乗車券
jōshaken
bus ticket



バス停
basu-tei
bus stop

関連用語 kanrenyōgo • vocabulary

料金
ryōkin
fare

車椅子対応
kurumaisu taiō
wheelchair access

時刻表
jikokuhyō
timetable

バス待合所
basu machiai-jo
bus shelter

...で停まりますか。
... de tomarimasuka?
Do you stop at...?

...へ行くのは、どのバスですか。
... e ikunowa dono basu desuka?
Which bus goes to...?



マイクロバス
maikuro basu
minibus



シャトルバス shatoru basu | shuttle bus



観光バス kankō basu | tourist bus

自動車1 jidōsha • car 1

外装 gaisō • exterior



車の種類 kuruma no shurui • types



コンパクトカー
kompakuto kā
compact



ハッチバック
hatchibakku
hatchback



セダン
sedan
sedan



ステーションワゴン
sutēshonwagon
station wagon



オープンカー
ōpun kā
convertible



スポーツカー
supōtsu kā
sports car



ワンボックスカー
wambokkusu kā
minivan



四輪駆動車
yonrin kudōsha
four-wheel drive



クラシックカー
kurashikku kā
vintage



リムジン
rimujin
limousine

ガソリンスタンド gasorin sutando
• gas station

ガソリンポンプ
gasorin pompu
pump

価格
kakaku
price



給油場
kyūyujō
forecourt

給気装置
kyūki sōchi
air supply

関連用語 kanrenyōgo • vocabulary

オイル
oiru
oil

有鉛
yūen
leaded

洗車
sensha
car wash

ガソリン
gasorin
gasoline

ディーゼル
dīzeru
diesel

不凍剤
futōzai
antifreeze

無鉛
muen
unleaded

整備工場
seibi kōjō
garage

フロントガラス洗浄液
furon-to-garasu senjōeki
windshield wash

満タンお願いします。
mantan onegaishimasu.
Fill the tank, please.

自動車 2 jidōsha • car 2

内装 naisō • interior

後部座席
kōbu zaseki
back seat

アームレスト
āmu resuto
armrest

ヘッドレスト
heddo resuto
headrest

ドアロック
doa rokku
door lock

ドアハンドル
doa handoru
handle



関連用語 kanrenyōgo • vocabulary

ツードア
tsū doa
two-door

フォードア
fō doa
four-door

オートマ
ōtoma
automatic

ブレーキ
burēki
brake

アクセル
akuseru
accelerator

スリードア
surī doa
three-door

マニュアル
manyuaru
manual

イグニッション
igunisshon
ignition

クラッチ
kuratchi
clutch

エアコン
eakon
air conditioning

...への行き方を教えてください。
... eno ikikata o oshiete kudasai?
Can you tell me the way to...?

駐車場はどこですか。
chūshajō wa doko desuka?
Where is the parking lot?

ここに駐車できますか。
kokoni chūsha dekimasuka?
Can I park here?

操作系 sōsakei • controls

ハンドル
handoru
steering
wheel

クラクション
kurakushon
horn

ダッシュボード
dasshubōdo
dashboard

ハザードランプ
hazādo rampu
hazard lights

カーナビ
kānabi
satellite navigation



左ハンドル hidari handoru | left-hand drive

水温計
suionkei
temperature gauge

カーオーディオ
kā ōdio
car stereo

ヒーター調節
hitā chōsetsu
heater controls

変速レバー
hensoku rebā
gearshift

タコメーター
takomētā
tachometer



右ハンドル migi handoru | right-hand drive

速度計
sokudokei
speedometer

燃料計
nenryōkei
fuel gauge

ライトスイッチ
raito suitchi
lights switch

オドメーター
odomētā
odometer

エアバッグ
eabaggu
air bag

自動車 3 jidōsha • car 3

機械構造 kikaikōzō • mechanics

フロントガラス洗浄液タンク
furonto-garasu senjōeki tanku
windshield fluid reservoir

オイルゲージ
oiru gēji
dipstick

エアフィルター
ea firutā
air filter

ブレーキフルードタンク
burēki furūdo tanku
brake fluid reservoir

バッテリー
batterī
battery



車体
shatai
body

冷却液タンク
reikyakueki tanku
coolant reservoir

シリンダーヘッド
shirindā heddo
cylinder head

管
kan
pipe

サンルーフ
sanrūfu
sunroof

ラジエーター
rajiētā
radiator

ファン
fan
fan

エンジン
enjīn
engine

ホイールキャップ
hoīru kyappu
hubcap

ギアボックス
gia bokkusu
gearbox

変速機
hensoku-ki
transmission

駆動軸
kudōjiku
driveshaft

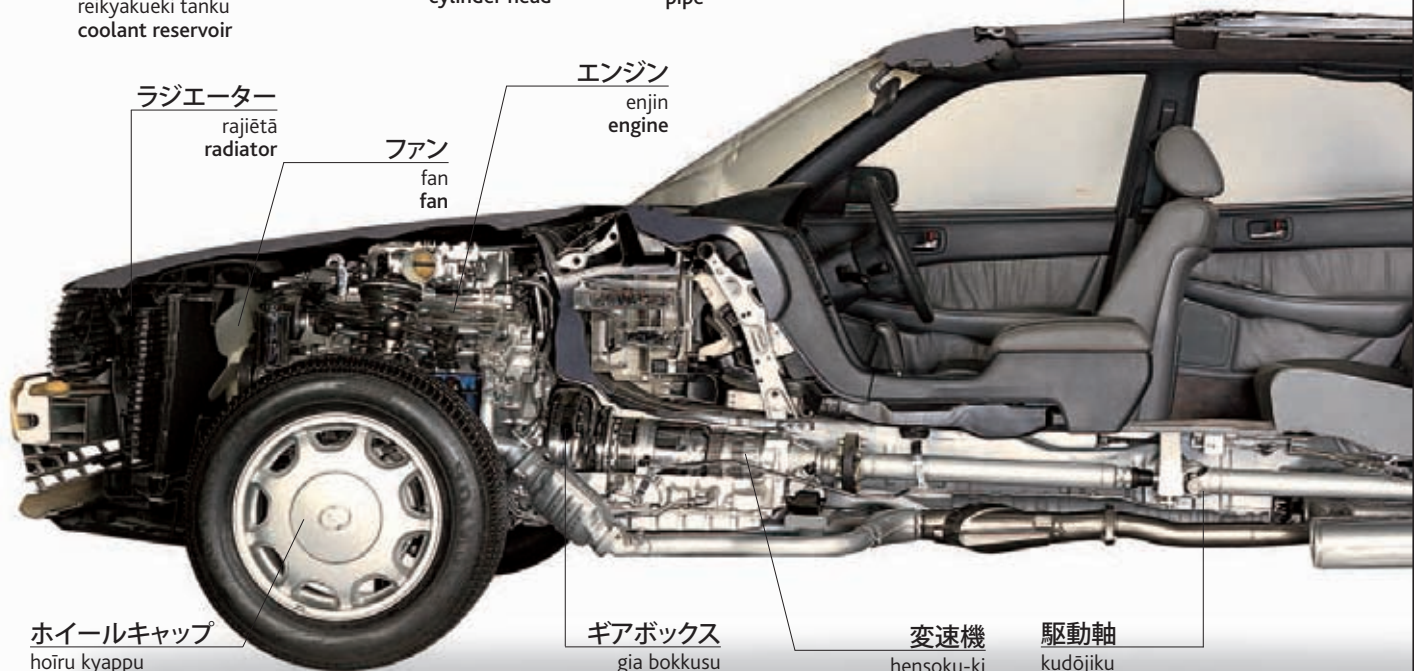

パンク panku • puncture

スペアタイヤ
supea taiya
spare tire

レンチ
renchi
tire iron

ホイールナット
hoīru natto
lug nuts

ジャッキ
jakki
jack

タイヤを交換する
taiya o kōkan suru
change a tire (v)

屋根
yane
roof

サスペンション
sasupenshon
suspension

マフラー
mafurā
muffler

排気管
haiki-kan
exhaust pipe

関連用語 kanrenyōgo • vocabulary

自動車事故
jidōsha jiko
car accident

故障
koshō
breakdown

保険
hoken
insurance

牽引車
ken'insha
tow truck

修理工
shūrikō
mechanic

タイヤ空気圧
taiya kūkiatsu
tire pressure

ヒューズボックス
hyūzu bokkusu
fuse box

スパークプラグ
supāku puragu
spark plug

ファンベルト
fam beruto
fan belt

燃料タンク
nenryō tanku
gas tank

タイミング
taimingu
timing

ターボチャージャー
tābochājā
turbocharger

配電器
haidenki
distributor

シャシー
shashī
chassis

ハンドブレーキ
handoburēki
handbrake

オルタネーター
orutanēta
alternator

カムベルト
kamu beruto
cam belt

車が故障しました。
kuruma ga koshō shimashita.
I've broken down.

車がスタートしません。
kuruma ga sutāto shimasen.
My car won't start.

修理はできますか。
shūri wa dekimasuka?
Do you do repairs?

エンジンがオーバーヒートしています。
enjin ga ōbāhito shite imasu.
The engine is overheating.

オートバイ ōtobai • motorcycle

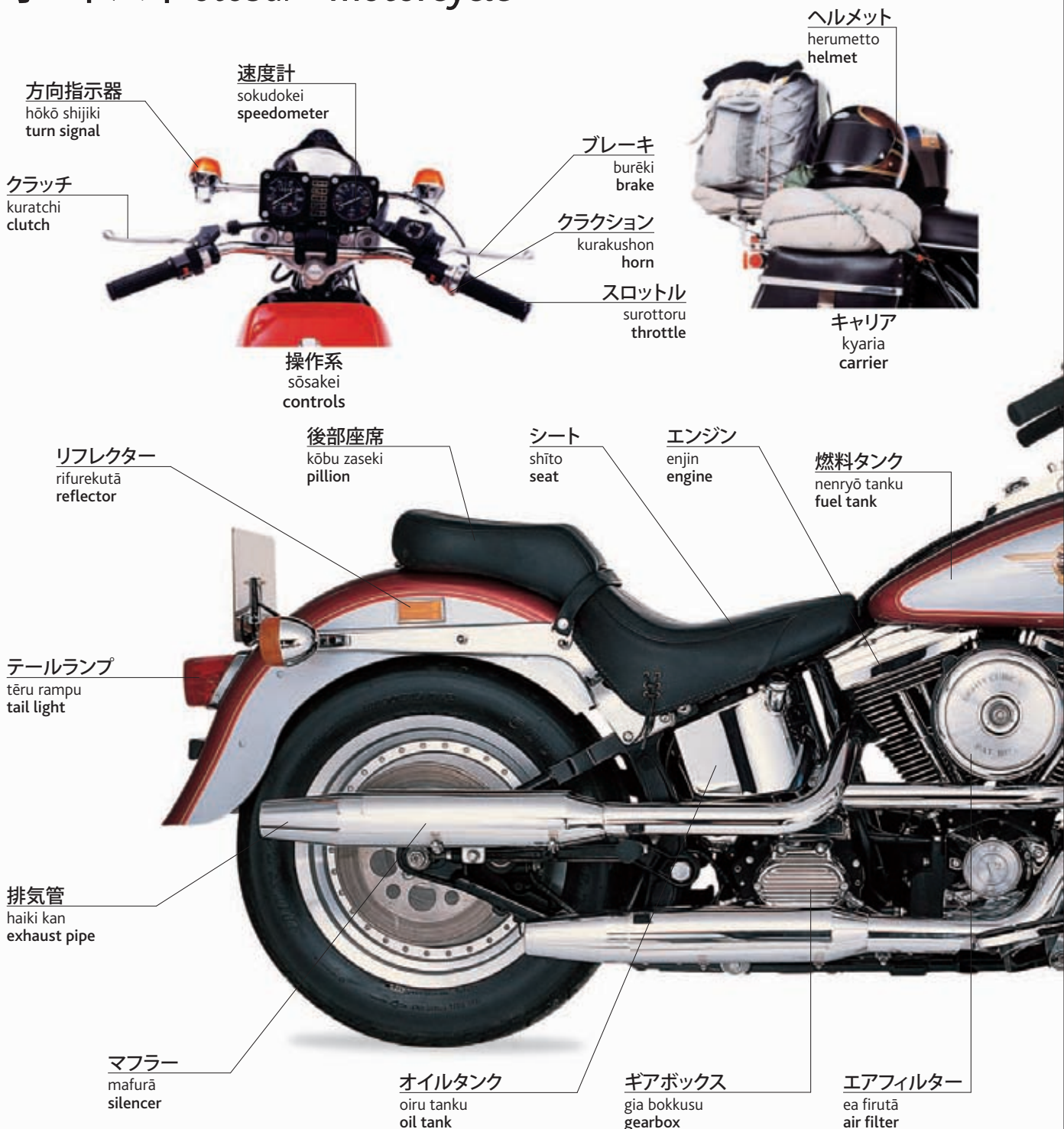

種類 shurui • types

バイザー
baizā
visor

革ジャン
kawajan
leathers

反射材
hanshazai
reflector strap

膝当て
hiza'ate
knee pad

バイクウエア baiku uea | clothing

ヘッドライト
heddo raito
headlight

サスペンション
sasupenshon
suspension

泥除け
doroyoke
mudguard

ブレーキペダル
burēki pedaru
brake pedal

アクスル
akusuru
axle

タイヤ
taiya
tire



レーシングバイク rēshingu baiku | racing bike

ウインドシールド
uindo-shīrudo
windshield



ツアラー tsuarā | tourer



ダートバイク dāto baiku | dirt bike

スタンド
sutando
stand



スクーター sukūtā | scooter

自転車 jitensha • bicycle



タンデム自転車 tandemu jitensha
tandem



ロードレーサー
rôdo rēsā
racing bike



マウンテンバイク
maunten baiku
mountain bike



ツーリング自転車
tsūringu jitensha
touring bike



ロードバイク
rôdo baiku
road bike

サドル
sadoru
saddle

シートピラー
shīto pirā
seat post

水筒
suitō
water bottle

フレーム
furēmu
frame

ブレーキ
burēki
brake

ハブ
habu
hub

変速機
hensoku-ki
gears

リム
rimu
rim

タイヤ
taiya
tire

チェーン
chēn
chain

ペダル
pedaru
pedal

コグ
kogu
cog

ヘルメット
herumetto
helmet



自転車道 jitensha-dō | bicycle lane

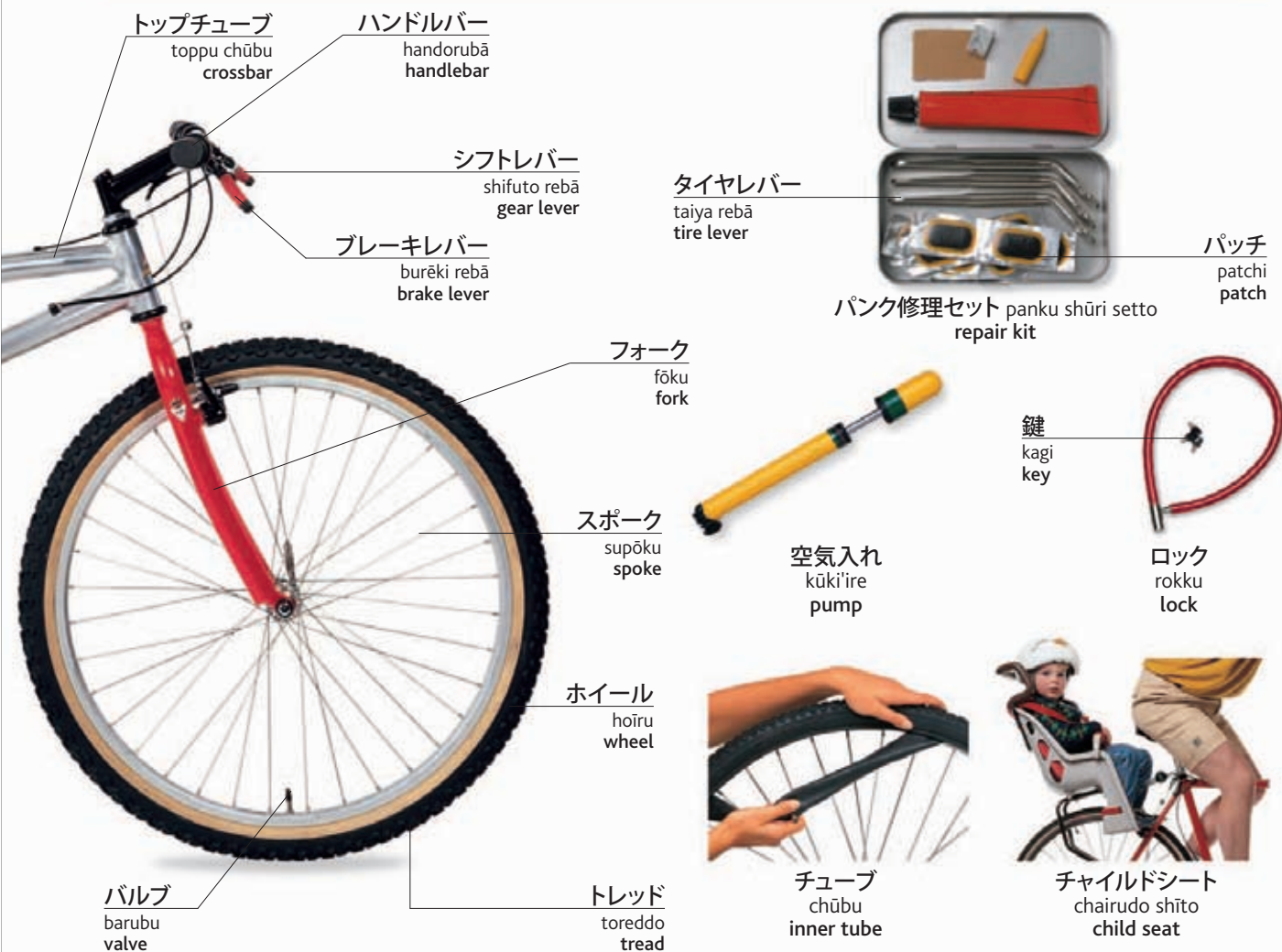

関連用語 kanrenyōgo • vocabulary

ライト raito lamp	スタンド sutando kickstand	ブレーキパッド burēki paddo brake block	籠 kago basket	トウクリップ to-u kurippu toe clip	ブレーキをかける burēki o kakeru brake (v)
テールライト tēru raito rear light	自転車ラック jitensha raku bike rack	ケーブル kēburu cable	ダイナモ dainamo dynamo	トウストラップ to-u sutorappu toe strap	自転車に乗る jitensha ni noru cycle (v)
リフレクター rifurekutā reflector	補助輪 hojorin stabilizers	スプロケット supuroketto sprocket	パンク panku puncture	漕ぐ kogu pedal (v)	変速する hensoku suru change gear (v)

列車 ressha • train

客車
kyakusha
car

ホーム
hōmu
platform

カート
kāto
cart



ホーム番号
hōmu bangō
platform number

通勤者
tsūkinsha
commuter

駅 eki | train station

列車の種類 ressha no shurui • types of train



蒸気機関車
jōki kikansha
steam train

エンジン
enjin
engine



ディーゼル機関車 dīzeru kikansha | diesel train

運転室
unten shitsu
driver's cab

レール
rēru
rail



電車
densha
electric train



高速列車
kōsoku ressha
high-speed train



モノレール
monorēru
monorail



地下鉄
chikatetsu
subway



路面電車
romen densha
tram



貨物列車
kamotsu ressha
freight train



客室
kyakushitsu
compartment

拡声装置
kakusei sōchi
public address system

時刻表
jikokuhyō
timetable



切符
kippu
ticket

網棚
amidana
luggage rack

車窓
shasō
window

線路
senro
track

扉
tobira
door

座席
zaseki
seat



改札口 kaisatsu-guchi | ticket gates



食堂車 shokudō-sha | dining car



コンコース konkōsu | concourse



寝台個室
shindai koshitsu
sleeping compartment

関連用語 kanrenyōgo • vocabulary

鉄道網
tetsudō-mō
rail network

地下鉄路線図
chikatetsu rosenzu
subway map

切符売場
kippu uriba
ticket office

通電レール
tsūden rēru
third rail

インターシティ列車
intāshiti ressha
intercity train

遅れ
okure
delay

検札員
kensatsuin
conductor

信号
shingō
signal

新幹線
shinkansen
bullet train

料金
ryōkin
fare

乗り換える
norikaeru
change (v)

非常レバー
hijō rebā
emergency lever

航空機 kōkūki • aircraft

定期旅客機 teiki-ryokakki • airliner



キャビン kyabin • cabin





熱気球
netsukikyū
hot-air balloon



マイクロライト
maikuroraito
ultralight



グライダー
guraidā
glider



複葉機
fukuyōki
biplane

プロペラ
puropera
propeller



軽飛行機
keihikōki
light aircraft



水上飛行機
suijō hikōki
sea plane



自家用ジェット機
jikayō jettoki
private jet



超音波ジェット機
chōompa jettoki
supersonic jet



ヘリコプター
herikoputā
helicopter

ローターブレード
rōtā burēdo
rotor blade



爆撃機
bakugekiki
bomber



戦闘機
sentōki
fighter plane

ミサイル
misairu
missile

関連用語 kanrenyōgo • vocabulary

パイロット
pairotto
pilot

離陸する
ririku suru
takeoff (v)

着陸する
chakuriku suru
land (v)

エコノミークラス
ekonomī kurasu
economy class

手荷物
tenimotsu
hand luggage

副操縦士
fukusōjūshi
copilot

飛ぶ
tobu
fly (v)

高度
kōdo
altitude

ビジネスクラス
bijinesu kurasu
business class

シートベルト
shīto beruto
seat belt

空港 kūkō • airport



エプロン
epuron
apron

牽引車
ken'insha
baggage trailer

ターミナル
tāminaru
terminal

作業車
sagyō-sha
service vehicle

通路
tsūro
walkway

定期旅客機 teiki ryokakki | airliner

関連用語 kanrenyōgo • vocabulary

滑走路
kassōro
runway

国際便
kokusai bin
international flight

国内便
kokunai bin
domestic flight

乗り継ぎ
noritsugi
connection

便名
binmei
flight number

出入国管理
shutsunyūkoku kanri
immigration

税関
zeikan
customs

超過荷物
chōka nimotsu
excess baggage

カルーセル
karūseru
carousel

警備
keibi
security

レントゲン検査装置
rentogen kensa sōchi
x-ray machine

旅行パンフレット
ryokō panfuretto
travel brochure

休暇
kyūka
vacation

チェックインする
chekkuin suru
check in (v)

管制塔
kanseitō
control tower

飛行機を予約する
hikōki o yoyaku suru
book a flight (v)

手荷物
tenimotsu
hand luggage

荷物
nimotsu
luggage

カート
kâto
cart



チェックインデスク
cheku in desuku
check-in desk



旅券 ryoken | passport

ビザ
biza
visa



入国審査
nyūkoku shinsa
passport control

搭乗券
tōjōken
boarding pass



航空券
kōkūken
ticket



出発ロビー
shuppatsu robī
departure lounge

ゲート番号
gēto bangō
gate number

出発便
shuppatsu bin
departures



案内板
annai-ban
information screen

目的地
mokutekichi
destination

到着便
tōchaku bin
arrivals



免税店
menzeiten
duty-free shop



荷物引き渡し
nimotsu hikiwatashi
baggage claim



タクシー乗り場
takushī noriba
cab stand



レンタカー
rentakā
car rental

船 fune • ship

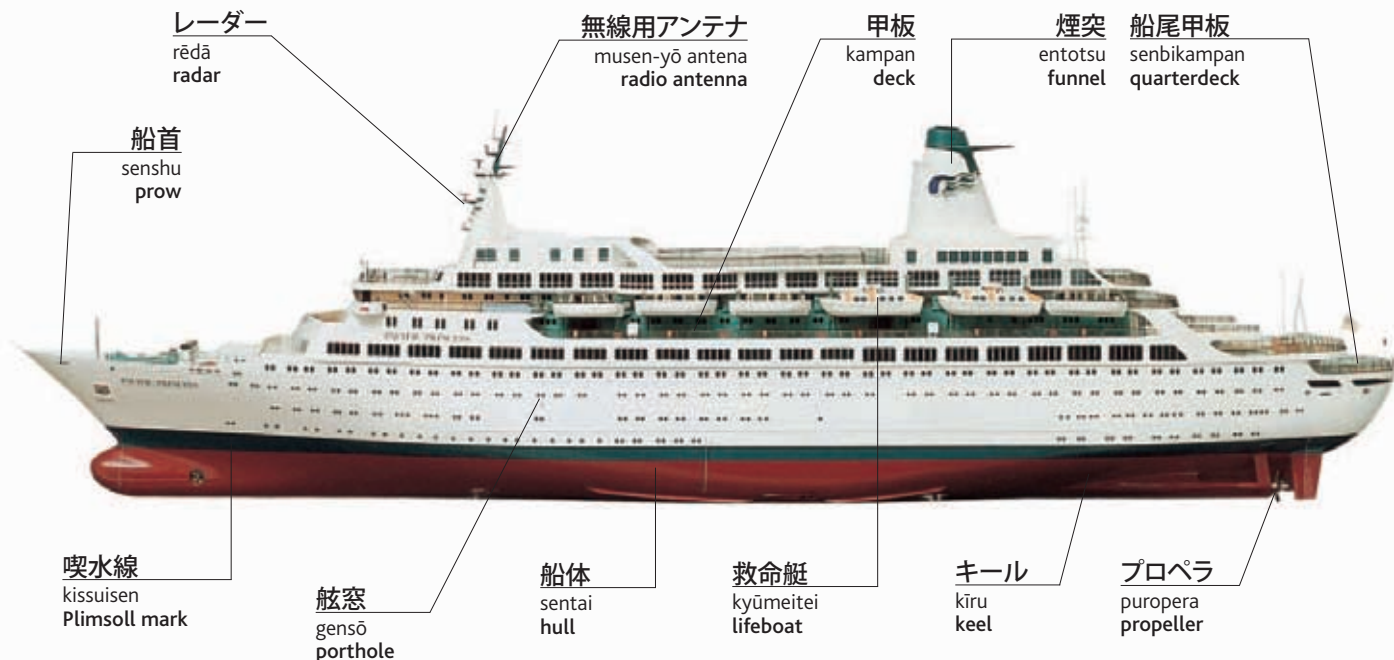

海洋定期船 kaiyō teikisen | ocean liner



船橋
senkyō
bridge



機関室
kikan shitsu
engine room



船室
senshitsu
cabin



調理室
chōri shitsu
galley

関連用語 kanrenyōgo • vocabulary

ドック
dokku
dock

ウィンドラス
windorasu
windlass

港湾
kōwan
port

船長
senchō
captain

舷門
genmon
gangway

高速モーターボート
kōsoku mōtābōto
speedboat

錨
ikari
anchor

ボート
bōto
rowboat

係船柱
keisenchū
bollard

カヌー
kanū
canoe

その他の船舶 sonota no sempaku • other ships



フェリー
ferī
ferry

船外機

sengaiki
outboard motor



ゴムボート
gomubōto
inflatable dinghy



水中翼船
suichūyoku-sen
hydrofoil



ヨット
yotto
yacht



カタマラン
katamaran
catamaran



曳航船
eikō-sen
tugboat



ホバークラフト
hobākurafto
hovercraft



コンテナ船
kontena-sen
container ship

索具

sakugu
rigging



帆船
hansen
sailboat

船倉

sensō
hold



貨物船
kamotsu-sen
freighter



石油タンカー
sekiyu tankā
oil tanker



航空母艦
kōkū bōkan
aircraft carrier



戦艦
senkan
battleship

展望塔

tembōtō
conning tower



潜水艦
sensuikan
submarine

港湾 kōwan • port

倉庫
sōko
warehouse

クレーン
kurēn
crane

フォークリフト
fōkurifuto
fork-lift

出入道路
shutsunyū dōro
access road

税関
zeikan
customs house



ドック
dokku
dock

コンテナ
kontena
container

波止場
hatoba
quay

貨物
kamotsu
cargo

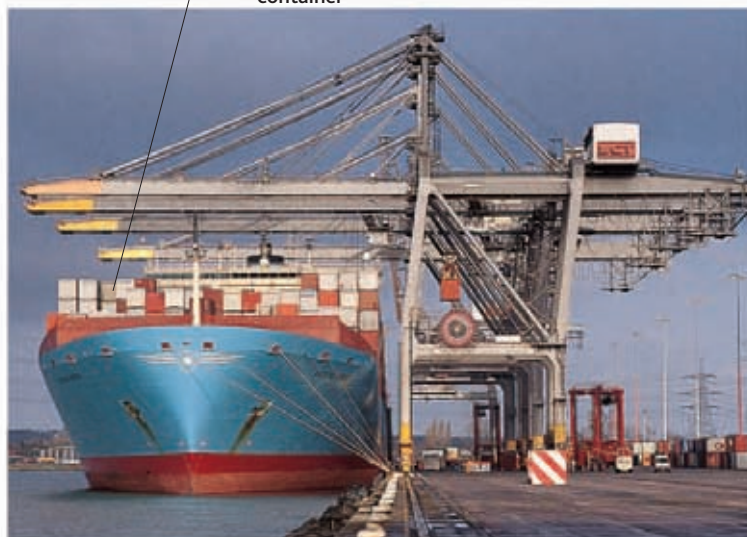

コンテナ港 kontena-kō | container port

フェリー乗り場
ferī noriba
ferry terminal

フェリー
ferī
ferry

切符売場
kippu uriba
ticket office

船客
senkyaku
passenger



船客港 senkyaku-kō | passenger port

網
ami
net

漁船
gyosen
fishing boat

係留索具
keiryū sakugu
mooring



漁港 gyokō | fishing port



マリーナ marina | marina



港 minato | harbor



栈橋 sambashi | pier



防波堤
bōhatei
jetty



造船所
zōsen jo
shipyard



灯台
tōdai
lighthouse

ランプ
rampu
lamp



ブイ
bui
buoy

関連用語 kanrenyōgo • vocabulary

沿岸警備隊
engan keibitai
coastguard

港長
kōchō
harbour master

錨を下ろす
ikari o orosu
drop anchor (v)

乾ドック
kandokku
dry dock

係留する
keiryū suru
moor (v)

波止場につける
hatoba ni tsukeru
dock (v)

乗船する
jōsen suru
board (v)

下船する
gesen suru
disembark (v)

出港する
shukkō suru
set sail (v)



PRESSION

ULTRA
3

DUNLOP
DDH III
4

DUNLOP

TOUR
EDITION
1

ProStaff
4

RAMBLE SPRINGS
GOLF CLUB

TOP-FLITE
HOT XL
4

ProStaff
4

RAM TOUR
1

MAXFLI
1

DISTANCE

TOP-FLITE
STRATA
3

ProStaff



スポーツ supōtsu
sports

アメリカンフットボール amerikan futtobōru

• American football

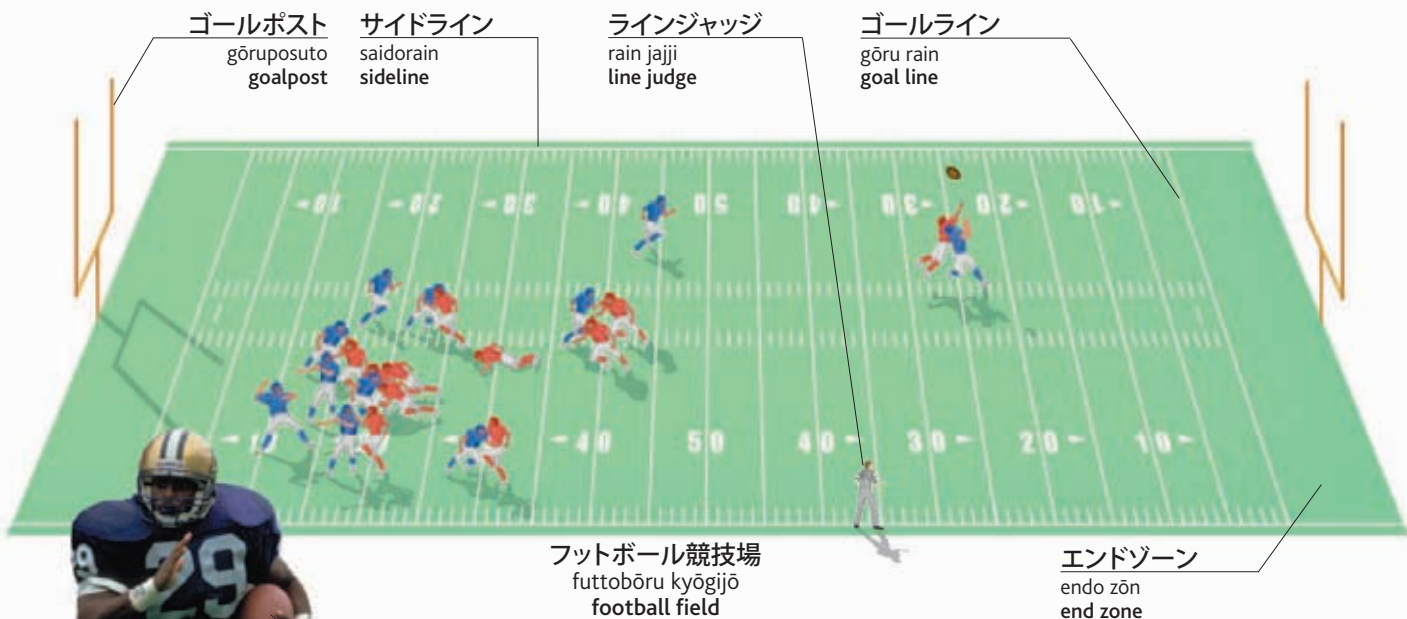

ゴールポスト
gōruposuto
goalpost

サイドライン
saidorain
sideline

ラインジャッジ
rain jajji
line judge

ゴールライン
gōru rain
goal line

フットボール競技場
futtobōru kyōgijō
football field

エンドゾーン
endo zōn
end zone

(フットボール用) ボール
(futtobōru-yō) bōru
football

パッド
paddo
pads

ヘルメット
herumetto
helmet

アメフトシューズ
amefuto shūzu
shoe



タックルする
takkuru suru
tackle (v)



パスする
pasu suru
pass (v)



捕球する
hokyū suru
catch (v)

フットボール選手
futtobōru senshu
football player

関連用語 kanrenyōgo • vocabulary

タイムアウト
taimu auto
time out

チーム
chīmu
team

防御
bōgyo
defense

チアリーダー
chiaridā
cheerleader

得点は何点ですか。
tokuten wa nanten desuka?
What is the score?

ファンブル
famburu
fumble

攻撃
kōgeki
attack

得点
tokuten
score

タッチダウン
tatchidaun
touchdown

どちらが勝っていますか。
dochira ga katte imasuka?
Who is winning?

ラグビー ragubī • rugby

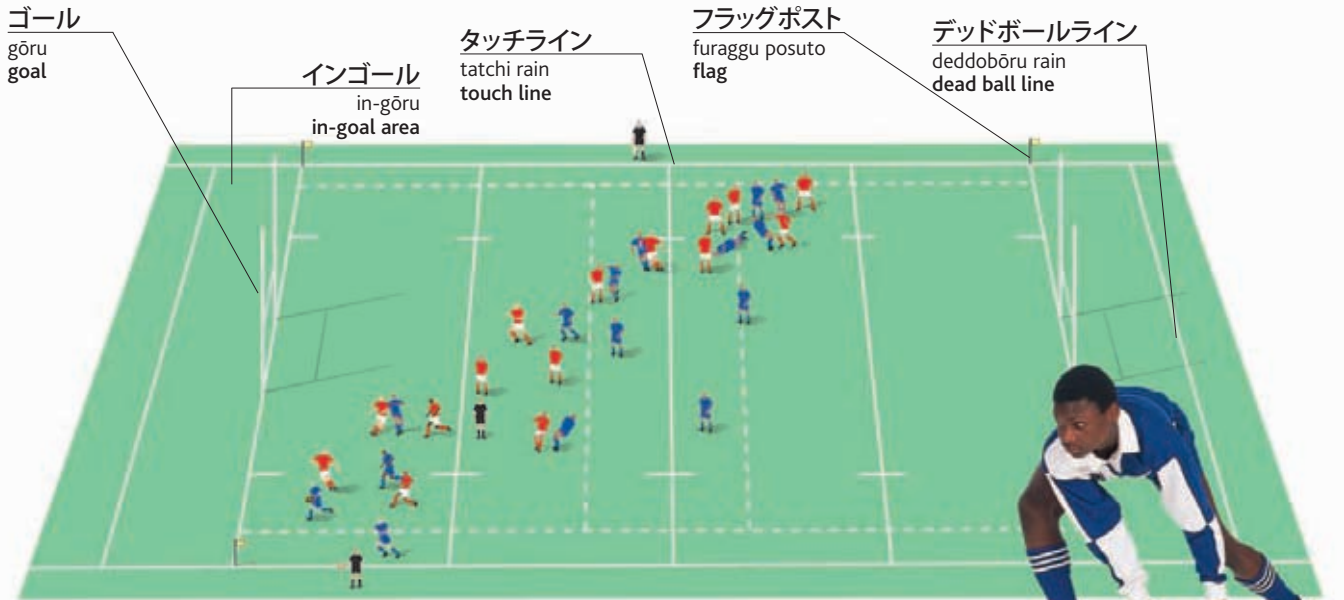

ゴール
gōru
goal

インゴール
in-gōru
in-goal area

タッチライン
tatchi rain
touch line

フラッグポスト
furaggu posuto
flag

デッドボールライン
deddobōru rain
dead ball line

ラグビー場 ragubī-jō | rugby field



ラグビーボール
ragubī bōru
ball



蹴る
keru
kick (v)



パスする
pasu suru
pass (v)



タックルする
takkuru suru
tackle (v)

投げる
nageru
throw (v)



トライ
torai
try

ラグビー着
ragubī-gi
rugby uniform

ラグビー選手
ragubi senshu
player



ラック raku | ruck



スクラム sukuramu | scrum

サッカー sakkā • soccer



サッカーボール
sakkā bōru
soccer ball

ゴールキーパー
gōrukīpā
goalkeeper

サッカー 着
sakkā-gi
soccer uniform

サッカー選手
sakkā senshu
soccer player

フォワード
fowādo
forward

審判
shimpan
referee

センターサークル
sentā sākuru
center circle



ゴールポスト
gōruposuto
goalpost

ネット
netto
net

クロスバー
kurosubā
crossbar



ゴール gōru | goal

サッカー場
sakkā-jō
soccer field



ドリブルする doriburu suru
dribble (v)



ヘディングする
hedingu suru
head (v)



フリーキック furī kikku | free kick

壁
kabe
wall

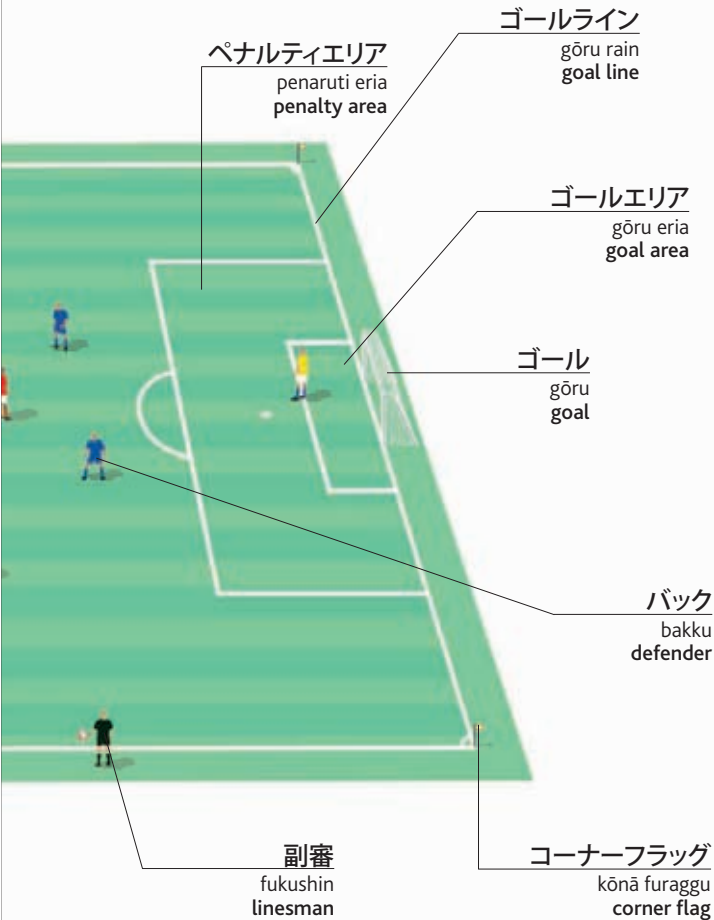

スローイン surō-in
throw-in



蹴る keru | kick (v)



送球する
sōkyū suru
pass (v)



シュートする
shūto suru
shoot (v)



セーブする
sēbu suru
save (v)



タックルする
takkuru suru
tackle (v)

サッカーシューズ
sakkā shūzu
boot

関連用語 kanrenyōgo • vocabulary

競技場
kyōgijō
stadium

ファウル
fauru
foul

イエローカード
ierō kādo
yellow card

連盟
renmei
league

延長時間
enchō jikan
extra time

1点あげる
itten ageru
score a goal (v)

コーナーキック
kōnā kikku
corner

オフサイド
ofu-saido
off-side

引分け
hikiwake
draw

補欠選手
hoketsusenshu
substitute

ペナルティー
penaruti
penalty

レッドカード
reddo kādo
red card

退場する
taijō suru
send off (v)

ハーフタイム
hāfu taimu
half time

代理
dairi
substitution

ホッケー hokkē • hockey

アイスホッケー aisu hokkē • ice hockey



フィールドホッケー fīrudo hokkē • field hockey

ホッケー用スティック
hokkē-yō sutikku
hockey stick



パック
paku
puck

アイスホッケー選手 aisu hokkē senshu
ice hockey player



スケートで滑る
sukēto de suberu
skate (v)

打つ
utsu
hit (v)

クリケット kuriketto • cricket

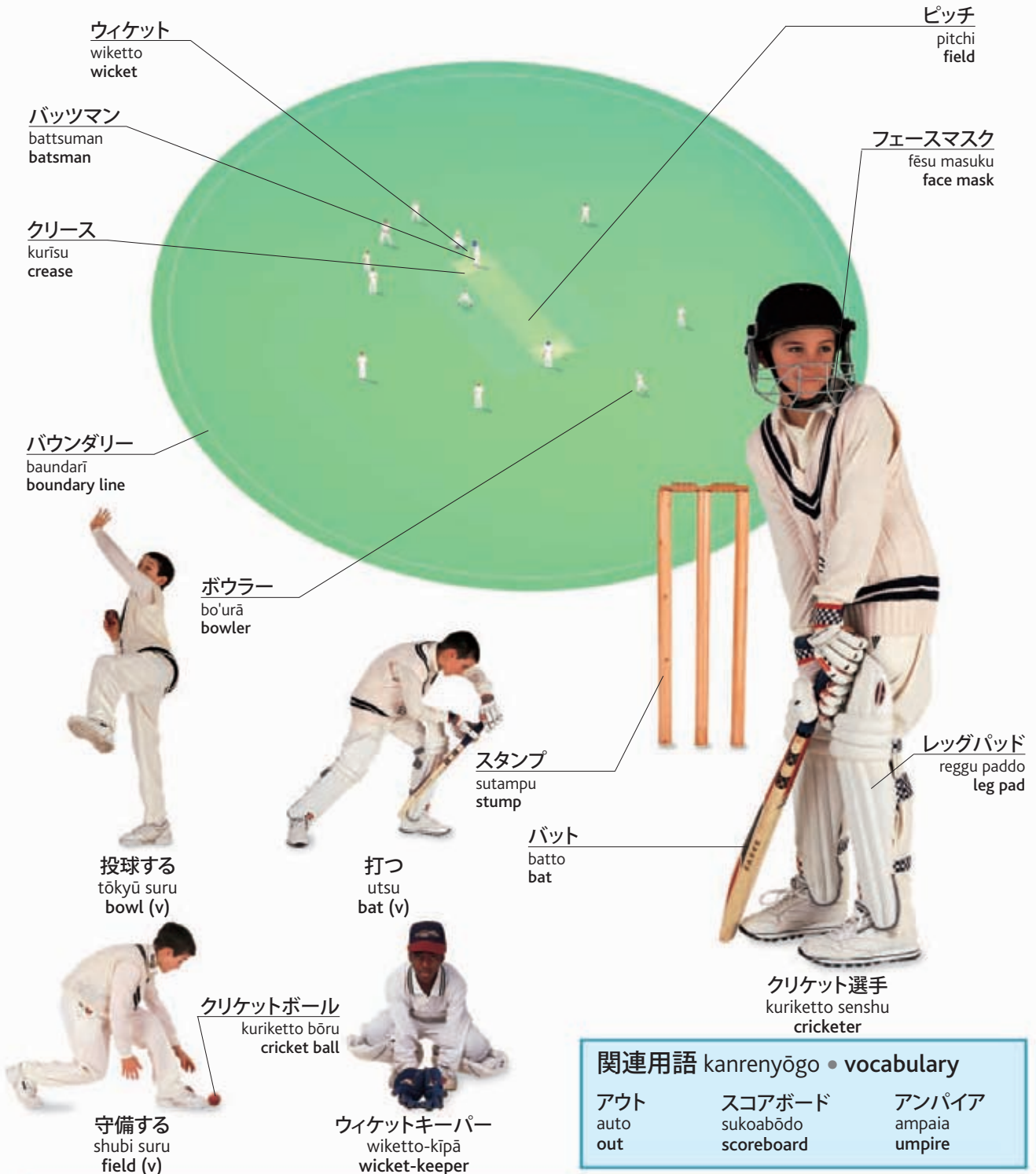

ウィケット
wiketto
wicket

バッツマン
battsuman
batsman

クリース
kurīsu
crease

バウンダリー
baundarī
boundary line

ボウラー
bo'urā
bowler

投球する
tōkyū suru
bowl (v)

打つ
utsu
bat (v)

クリケットボール
kuriketto bōru
cricket ball

守備する
shubi suru
field (v)

ウィケットキーパー
wiketto-kīpā
wicket-keeper

ピッチ
pitchi
field

フェースマスク
fēsu masuku
face mask

スタンプ
sutampu
stump

バット
batto
bat

レッグパッド
reggu paddo
leg pad

クリケット選手
kuriketto senshu
cricketer

関連用語 kanrenyōgo • vocabulary

アウト
auto
out

スコアボード
sukoabōdo
scoreboard

アンパイア
ampaia
umpire

バスケットボール basukettobōru • basketball

サイドライン
saidorain
sideline

審判
shimpan
referee

センターサークル
sentā sākuru
center circle

フリースローライン
furīsurō rain
free-throw line

エンドライン
endorain
endline



ボール
bōru
ball

ゼッケン
zekken
number

バックボード
bakkubōdo
backboard

ゴールリング
gōru ringu
hoop

ゴールネット
gōru netto
net

バスケット
basuketto
basket

コート kōto | court

センターライン
sentārain
centerline

スリーポイントライン
surī-pointo rain
three-point line

関連用語 kanrenyōgo • vocabulary

パス pasu pass
スローイン surō-in throw-in

ファウル fauru foul
ジャンプボール jampu bōru jump ball

リバウンド ribaundo rebound
アウトオブバウンズ auto obu baunzu out of bounds

バスケットボール選手
basukettobōru senshu | basketball player

動作 dōsa • actions



投げる
nageru
throw (v)



受ける
ukeru
catch (v)



シュートする
shūto suru
shoot (v)



ジャンプする
jampu suru
jump (v)



ダンクシュートする
dankushūto suru
dunk (v)



マークする
māku suru
mark (v)



ブロックする
burokku suru
block (v)



バウンドする
baundo suru
bounce (v)



サポーター
sapōtā
knee support

バレーボール barēbōru • volleyball

ブロックする
burokku suru
block (v)

ネット
netto
net

レシーブする
reshību suru
dig (v)



審判
shimpan
referee

コート kōto | court

野球 yakyū • baseball

球場 kyūjō • field

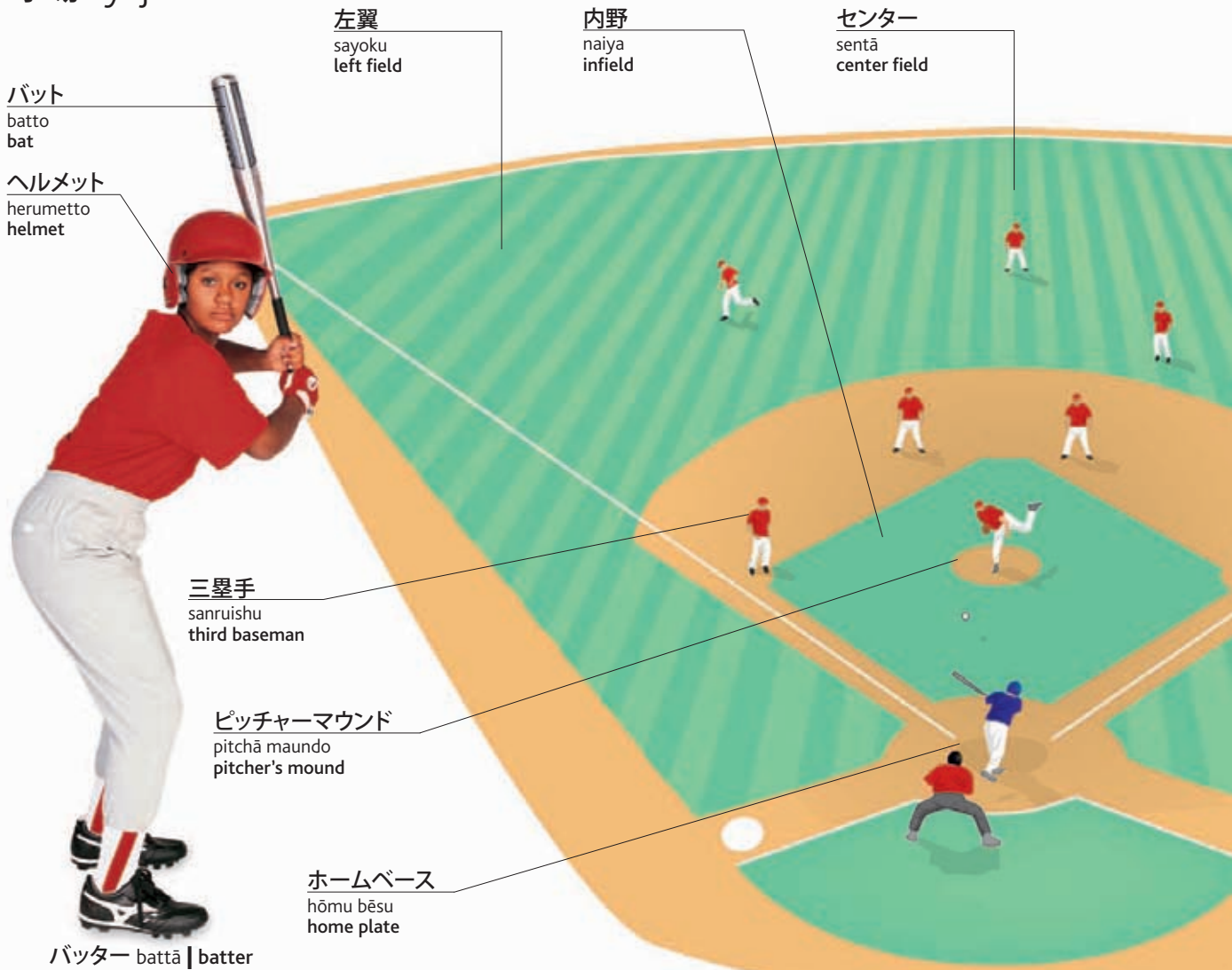

関連用語 kanrenyōgo • vocabulary

イニング iningu inning	セーフ sēfu safe	ファウルボール fauru bōru foul ball
ラン ran run	アウト auto out	ストライク sutoraiku strike



ミット mitto
mitt

ボール
bōru
ball



マスク masuku
mask

動作 dōsa • actions

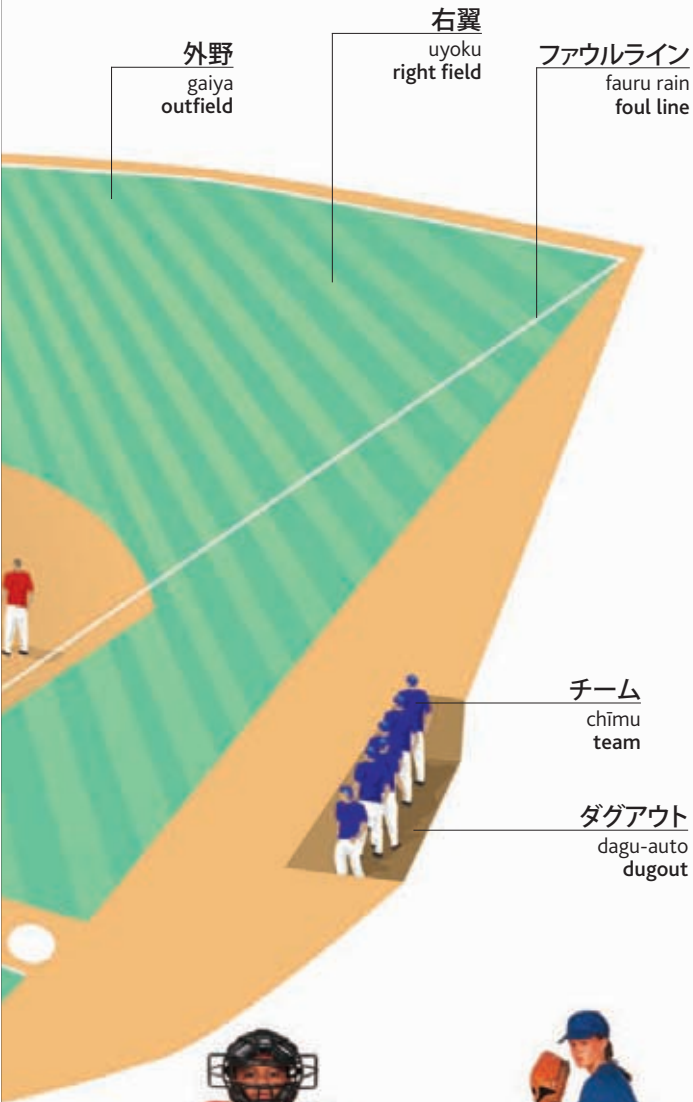

投げる nageru | throw (v)



捕球する hokyū suru | catch (v)



走る
hashiru
run (v)



フィールディングする
firudingu suru | field (v)

スライディングする
suraidingu suru
slide (v)



タッチアウトする
tatchiauto suru
tag (v)

投球する
tōkyū suru
pitch (v)



打つ
utsu
bat (v)

審判
shimpan
umpire

野球をする yakyū o suru | play (v)



キャッチャー kyatchā
catcher



ピッチャー pitchā
pitcher

テニス tennis • tennis

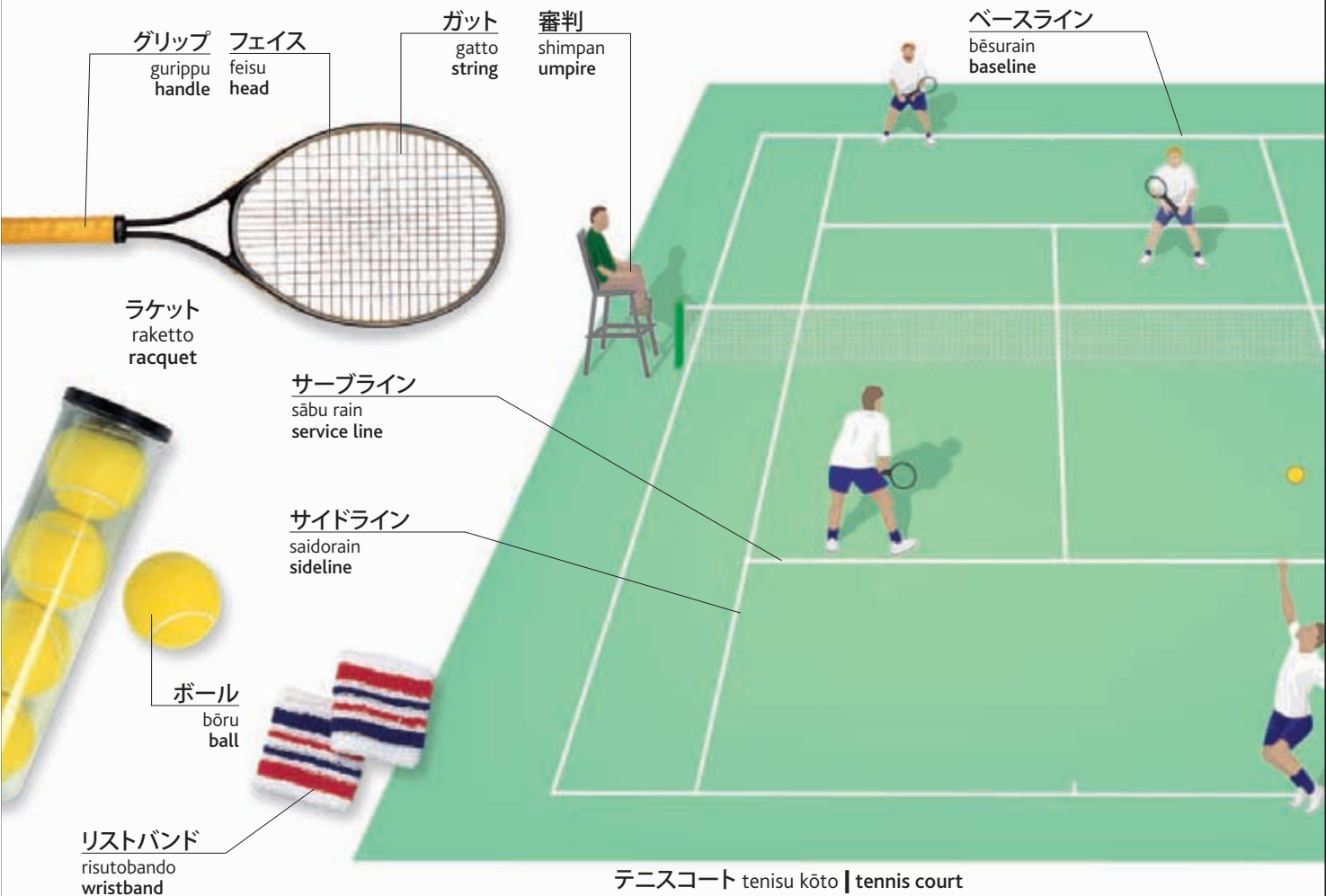

テニスコート tennis kōto | tennis court

関連用語 kanrenyōgo • vocabulary

シングルス
shingurusu
singles

セット
setto
set

ラブ
rabu
love

フォルト
foruto
fault

スライス
suraisu
slice

線審
senshin
linesman

ダブルス
daburusu
doubles

マッチ
matchi
match

デュース
dyūsu
deuce

エース
ēsu
ace

ラリー
rarī
rally

選手権
senshuken
championship

ゲーム
gēmu
game

タイブレーク
taiburēku
tiebreak

アドバンテージ
adobantēji
advantage

ドロブショット
doroppu shotto
dropshot

レット
retto!
let!

スピン
supin
spin



ストローク sutorōku • strokes



ラケットスポーツ raketto supōtsu • racquet games

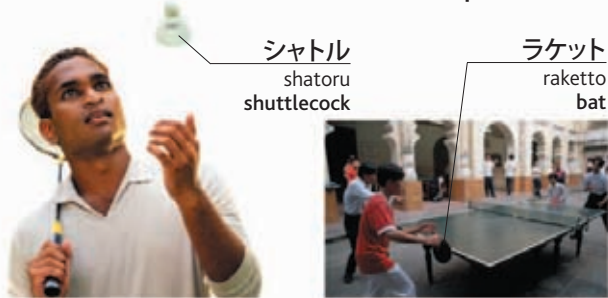

バドミントン
badominton
badminton

卓球
takkyū
table tennis



ゴルフ gorufu • golf



用具 yōgu • equipment



ゴルフクラブ
gorufu kurabu
• golf clubs



動作 dōsa • actions



関連用語 kanrenyōgo • vocabulary

ホールインワン
hōru in wan
hole in one

パー
pā
par

ハンディキャップ
handikyappu
handicap

キャディ
kyadi
caddy

バックスイング
bakkusuingu
backswing

ストローク
sutorōku
stroke

アンダーパー
andā pā
under par

オーバーパー
ōbā pā
over par

トーナメント
tōnamento
tournament

観衆
kanshū
spectators

素振り
suburi
practice swing

プレーの線
purē no sen
line of play

陸上競技 rikujō kyōgi • track and field

レーン
rēn
lane

トラック
torakku
track

ゴール
gōru
finishing line

スタートライン
sutāto rain
starting line

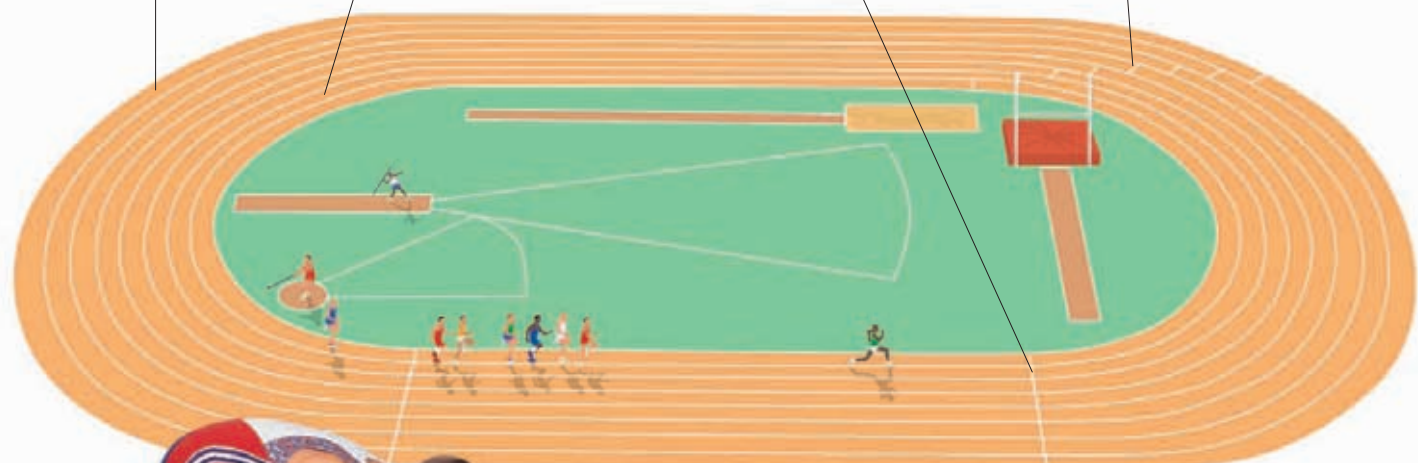

グラウンド
gurando
field

陸上競技者
rikujō kyōgi-sha
athlete



短距離走者
tankyori sōsha
sprinter

スターティングブロック
sutātingu burokku
starting blocks

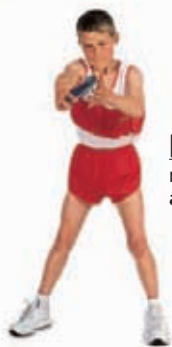

円盤投げ
emban-nage
discus



砲丸投げ
hōgannage
shotput



槍投げ
yarinage
javelin

関連用語 kanrenyōgo • vocabulary

競争
kyōsō
race

記録
kiroku
record

写真判定
shashin hantei
photo finish

棒高跳び
bōtakatobi
pole vault

時間
jikan
time

記録を破る
kiroku o yaburu
break a record (v)

マラソン
marason
marathon

自己最高記録
jiko saikō kiroku
personal best



ストップウォッチ
sutoppuwotchi
stopwatch

バトン
baton
baton



リレー競争
rirē kyōsō
relay race

バー
bā
crossbar



走り高跳び
hashiritakatobi
high jump



走り幅跳び
hashirihabatobi
long jump



ハードル走
hādorūsō
hurdles

体操競技 taisō kyōgi • gymnastics



跳馬
chōba
horse

跳馬 (項目)
chōba (kōmoku)
vault

跳躍板
chōyaku-ban
springboard



宙返り
chūgaeri
somersault



マット
matto
mat

床運動
yuka undō
floor exercises

体操選手
taisō senshu
gymnast



平均台 heikindai | beam

リボン
ribon
ribbon



側転
sokuten
tumble

新体操
shintai shō
rhythmic gymnastics

関連用語 kanrenyōgo • vocabulary

鉄棒
tetsubō
horizontal bar

鞍馬
amba
pommel horse

吊り輪
tsuriwa
rings

メダル
medaru
medals

銀
gin
silver

平行棒
heikōbō
parallel bars

段違い平行棒
danchigai heikōbō
asymmetric bars

表彰台
hyōshō dai
podium

金
kin
gold

銅
dō
bronze

格闘技 kakutōgi • combat sports

相手
aite
opponent

ヘッドガード
heddogādo
guard

ミット
mitto
glove

帯
obi
belt

テコンドー tekondō | tae-kwon-do

面
men
mask

竹刀
shinai
sword

合気道 aikidō | aikido

剣道 kendō | kendo

カンフー kanfū
kung fu



キックボクシング
kikkubokushingu | kickboxing

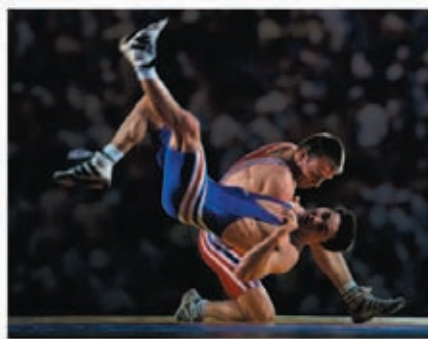

レスリング resuringu | wrestling



ボクシング bokushingu | boxing



空手 karate | karate



柔道 jūdō | judo



技 waza • actions



袈裟固 kesagatame | fall



襟掴み erizukami | hold



投げ nage | throw



抑え osae | pin



蹴り keri | kick



突き tsuki | punch



払い harai | strike



手刀打ち shutō uchi | chop



飛び蹴り tobi-geri | jump



受け uke | block

関連用語 kanrenyōgo • vocabulary

リング
ringu
boxing ring

ラウンド
raundo
round

拳
kobushi
fist

黒帯
kuro obi
black belt

カポエイラ
kapoeira
capoeira

グローブ
gurōbu
boxing gloves

試合
shiai
bout

ノックアウト
nokku auto
knock out

護身
goshin
self defense

相撲
sumō
sumo wrestling

マウスピース
mausu pīsu
mouth guard

練習試合
renshū-jiai
sparring

パンチバッグ
panchi baggu
punch bag

武道
budō
martial arts

太極拳
taijyokuken
tai-chi

水泳 suiei • swimming

水泳用品 suiei yōhin • equipment



アームバンド
āmubando
armband



ゴーグル gōguru | goggles

鼻栓
hana sen
nose clip



スイムボード
suimubōdo | float



水着 mizugi | swimsuit

レーン
rēn
lane

水
mizu
water

スタート台
sutāto dai
starting block



プール pūru | swimming pool

水泳帽
suei-bō
cap

海水パンツ
kaisui pantsu
trunks

水泳選手 suiei senshu | swimmer

飛び板
tobi-ita
springboard

飛び込み選手
tobikomi senshu
diver



飛び込む tobikomu | dive (v)



泳ぐ oyogu | swim (v)



回転 kaiten | turn

泳法 eihō • styles



クロール kurōru | front crawl



平泳ぎ hiraoyogi | breaststroke



背泳ぎ seoyogi | backstroke

かき
kaki
stroke



バタフライ batafurai | butterfly

蹴り
keri
kick

スキューバダイビング sukyūba daibingu • scuba diving

ウェットスーツ
wettosūtsu
wetsuit

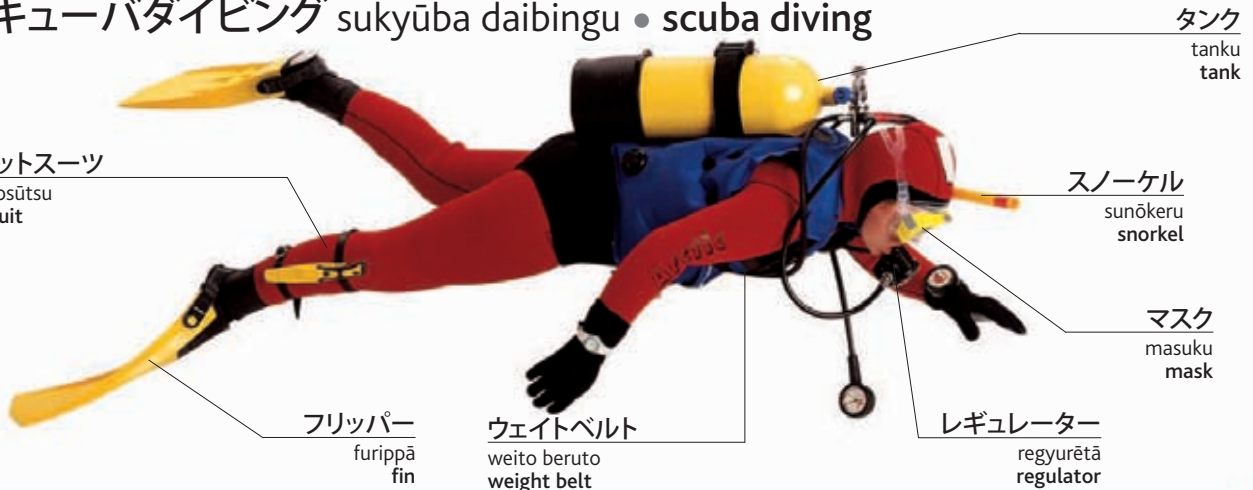

タンク
tanku
tank

スノーケル
sunōkeru
snorkel

マスク
masuku
mask

レギュレーター
regyurētā
regulator

ウェイトベルト
weito beruto
weight belt

フリッパー
furippā
fin

関連用語 kanrenyōgo • vocabulary

飛び込み
tobikomi
dive

立ち泳ぎする
tachioyogi suru
tread water (v)

ロッカー
rokkā
lockers

水球
suikyū
water polo

浅瀬
asase
shallow end

こむら返り
komuragaeri
cramp

高飛び込み
takatobikomi
high dive

飛び込みスタート
tobikomi sutāto
racing dive

救助員
kyūjo-in
lifeguard

深み
fukami
deep end

シンクロナイズドスイミング
shinkuronaizudo suimingu
synchronized swimming

溺れる
oboreru
drown (v)

セーリング sēringu • sailing



コンパス
kompasu
compass



錨
ikari
anchor

ヘッドセール
heddosēru
headsail

クリート
kurīto
cleat

サイドデッキ
saido dekki
side deck

船首
senshu
bow

舵棒
kaji bō
tiller

船体
sentai
hull

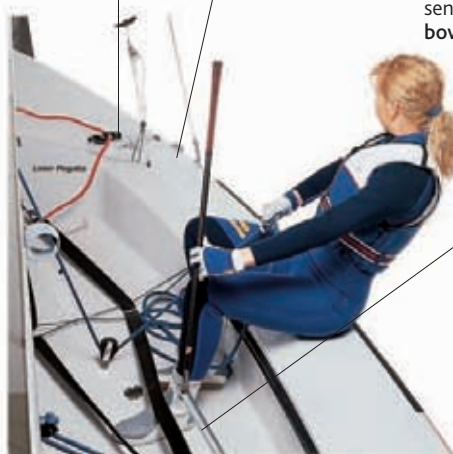

航行する kōkō suru | navigate (v)

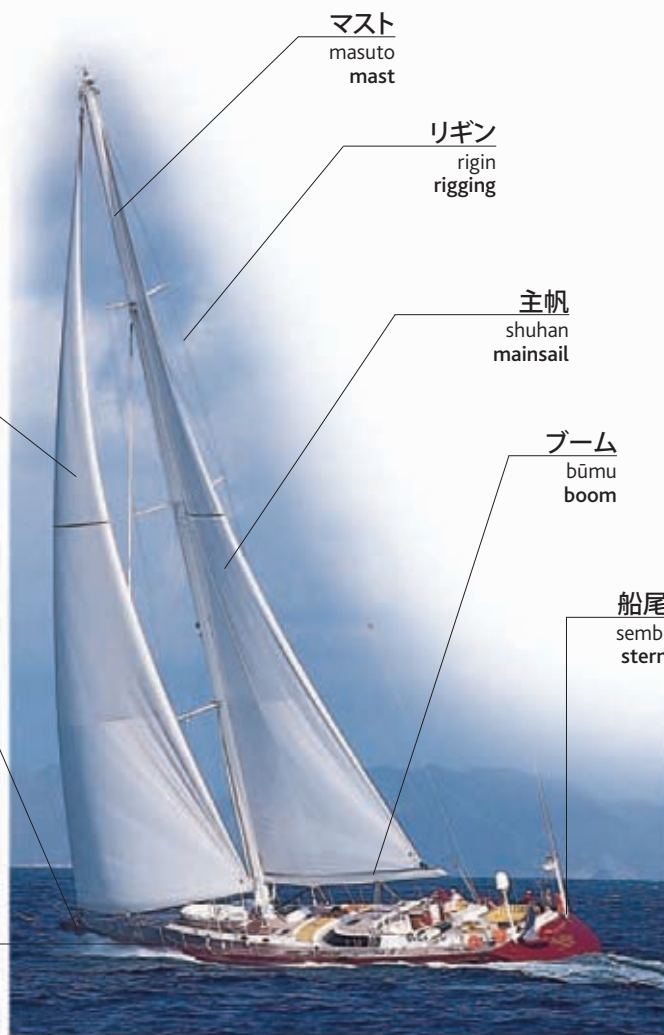

ヨット yotto | yacht

安全用具 anzen yōgu • safety



照明弾
shōmeidan
flare



救命ブイ
kyūmei bui
lifebuoy



救命胴衣
kyūmei dōi
life jacket



救命ボート
kyūmei bōto
life raft

水上スポーツ suijō supōtsu • watersports

漕ぎ手
kogite
rower



漕ぐ kogu | row (v)

オール
ōru
oar

カヤック
kayakku
kayak



カヌー
kanū
canoeing

パドル
padoru
paddle

セール
sēru
sail



ウインドサーフィン uindosāfin
windsurfing

ウインドサーファー
uindosāfā
windsurfer

ボード
bōdo
board

フットストラップ
futtosutorappu
footstrap

サーフボード
sāfubōdo
surfboard



サーフィン
sāfin
surfing

水上スキー板
suijōsukī ita
ski



水上スキー
suijōsukī
waterskiing



高速ボート
kōsoku bōto
speed boating



ラフティング
rafutingu
rafting



ジェットスキー
jettosukī
jet skiing

関連用語 kanrenyōgo • vocabulary

水上スキーヤー
suijōsukīyā
waterskier

乗組員
norikumi'in
crew

風
kaze
wind

寄せ波
yosenami
surf

シート
shīto
sheet

センターボード
sentābōdo
centerboard

サーファー
sāfā
surfer

タッキングする
takkingu suru
tack (v)

波
nami
wave

急流
kyūryū
rapids

舵
kaji
rudder

転覆する
tempuku suru
capsize (v)

乗馬 jōba • horseback riding

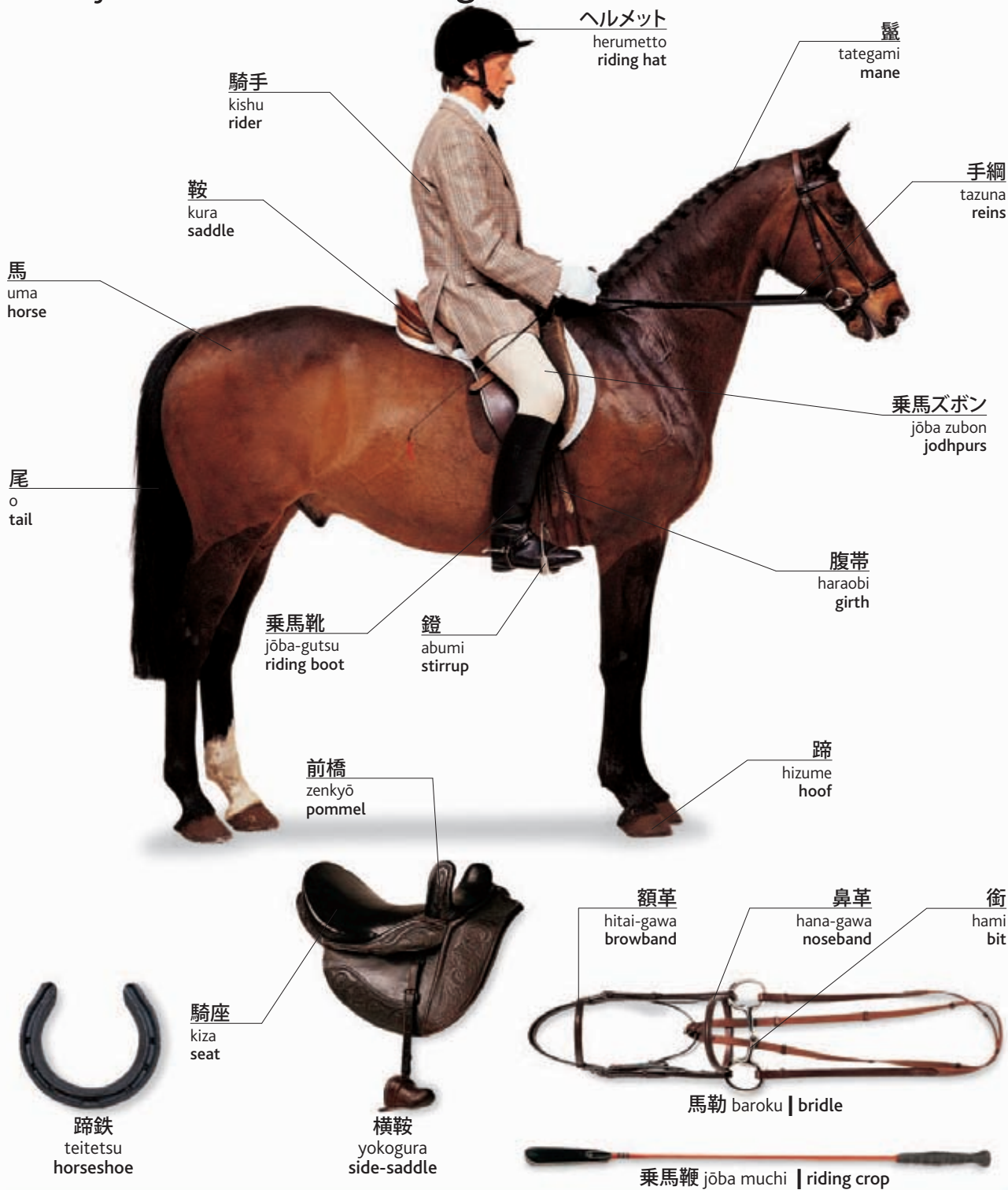

競技 kyōgi • events

競走馬
kyōsōba
racehorse



競馬
keiba
horse race

障害物
shōgaibutsu
fence



障害競走
shōgai kyōsō
steeplechase



繋駕競走
keiga kyōsō
harness race



ロデオ
rodeo
rodeo



障害飛越
shōgai hietsu
showjumping



馬車レース
basha rēsu
carriage race



トレッキング tōrekkingu | trekking



馬場馬術 baba bajutsu | dressage



ポロ poro | polo

関連用語 kanrenyōgo • vocabulary

常歩
namiashi
walk

駆歩
kakeashi
canter

ジャンプ
jampu
jump

端綱
hazuna
halter

パドック
padokku
paddock

平地競走
heichi kyōsō
flat race

速歩
haya'ashi
trot

襲歩
shūho
gallop

馬手
umate
groom

馬屋
umaya
stable

アリーナ
arīna
arena

競馬場
keibajō
racecourse

釣り tsuri • fishing



錘 omori | weight

返し
kaeshi
barb

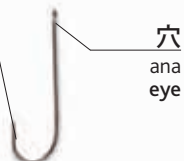

穴
ana
eye

釣り針
tsuribari
fishhook



餌 esa | bait



浮き
uki
float



ルアー
ruā
lure



フライ
furai
fly



手網
tamo
landing net



タックルボックス
takkuru bokkusu
tackle box



フラシ
furashi
keep net

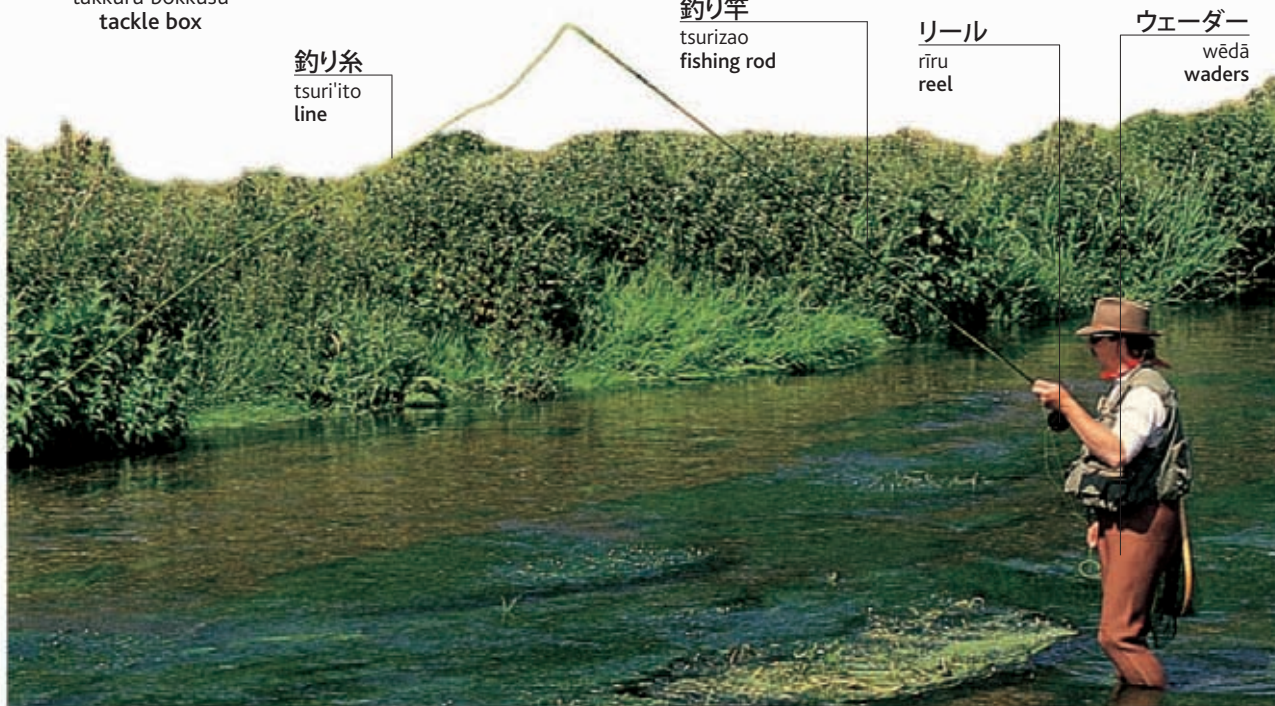

釣り糸
tsuri'ito
line

釣り竿
tsurizao
fishing rod

リール
rīru
reel

ウェーダー
wēdā
waders

釣り人 tsuribito | angler

釣りの種類 tsuri no shurui • types of fishing



淡水釣り
tansui-zuri
freshwater fishing



フライフィッシング
furai fisshingu
fly fishing



スポーツフィッシング
supōtsu fisshingu
sport fishing



深海釣り
shinkai-zuri
deep sea fishing

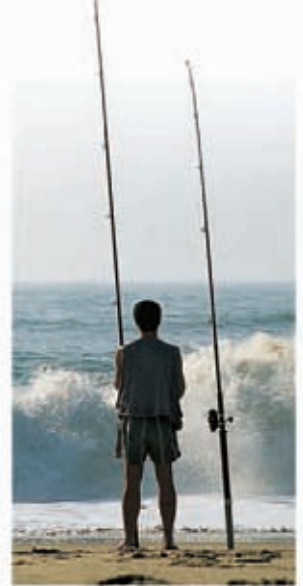

磯釣り
isozuri
surfcasting

動作 dōsa • activities



投げる
nageru
cast (v)



釣る
tsuru
catch (v)



引き寄せる
hikiyoseru
reel in (v)



網打ちする
amiuchi suru
net (v)



放す
hanasu
release (v)

関連用語 kanrenyōgo • vocabulary

誘き寄せる
obikiyoseru
bait (v)

タックル
takkuru
tackle

雨具
amagu
waterproofs

釣り許可証
tsuri kyokashō
fishing permit

魚籠
biku
creel

針にかかる
hari ni kakaru
bite (v)

スプール
supūru
spool

竿
sao
pole

海釣り
umizuri
marine fishing

ヤス漁
yasu ryō
spearfishing

スキー sukī • skiing

スキー場
sukī-jō
ski slope

リフト
rifuto
chairlift

ケーブルカー
kēburu kā
cable car

スキーウェア
sukīwea
ski suit

ストック
sutokku
ski pole

グローブ
gurōbu
glove

ゲレンデ
gerende
ski run

スキー靴
sukī-gutsu
ski boot

安全柵
anzen saku
safety barrier

スキー板
sukī ita
ski

エッジ
ejji
edge

スキーヤー
sukiyā
skier

トップ
toppu
tip



競技 kyōgi • events



滑降
kakkō
downhill skiing



旗門
kimon
gate
回転
kaiten
slalom



ジャンプ
jampu
ski jump



クロスカントリー
kurosu-kantōri
cross-country skiing

ウィンタースポーツ wintā supōtsu • winter sports



アイスクライミング
aisu kuraimingu
ice climbing



アイススケート
aisu sukēto
ice skating



フィギュアスケート
figyuasukēto
figure skating

ゴーグル
gōguru
goggles



スノーボード
sunōbōdo
snowboarding

スケート靴
sukēto-gutsu
skate



ボブスレー
bobusurē
bobsled



リュージュ
ryūju
luge



スノーモービル
sunōmōbiru
snowmobile



そり滑り
sori suberi
sledding

関連用語 kanrenyōgo • vocabulary

アルペンスキー
arupen sukī
alpine skiing

犬ぞり滑り
inu-zori suberi
dog sledding

大回転
daikaiten
giant slalom

スピードスケート
supīdo sukēto
speed skating

ゲレンデ外
gerende-gai
off-piste

バイアスロン
baiasuron
biathlon

カーリング
kāringu
curling

雪崩
nadare
avalanche

他のスポーツ ta no supōtsu • other sports



グライダー
guraidā
glider

ハングライダー
hangu guraidā
hang-glider



ハンググライディング
hangu guraidingu
hang-gliding

グライディング
guraidingu
gliding

パラシュート
parashūto
parachute

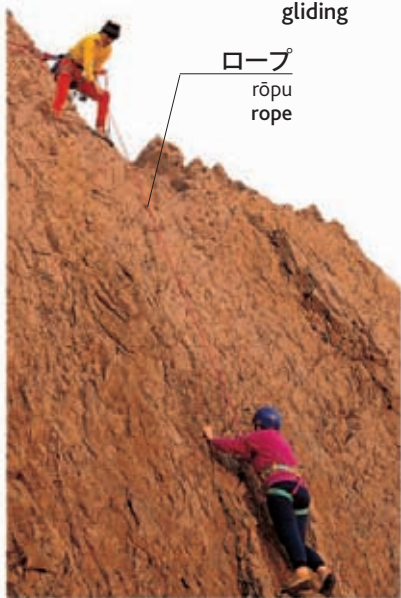

ロープ
rōpu
rope

ロッククライミング
roku kuraimingu
rock climbing



パラシュート降下
parashūto kōka
parachuting



パラグライディング
paraguraidingu
paragliding



スカイダイビング
sukaidaibingu
skydiving



アブザイレン
abuzairen
rappelling



バンジージャンプ
banji jampu
bungee jumping



ラリー
rari
rally driving



レーサー
rēsā
racing driver

自動車レース
jidōsha rēsu
auto racing



モトクロス
motokurosu
motorcross



オートバイレース
ōtobai rēsu
motorcycle racing



スケートボード
sukētobōdo
skateboard

ローラースケート靴
rōrāsukēto-gutsu
rollerskate

スケートボード乗り
sukētobōdo-nori
skateboarding



ローラースケート
rōrāsukēto
roller skating

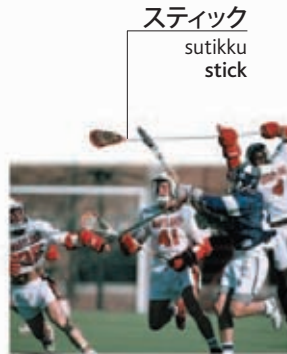

スティック
sutikku
stick

ラクロス
rakurosu
lacrosse

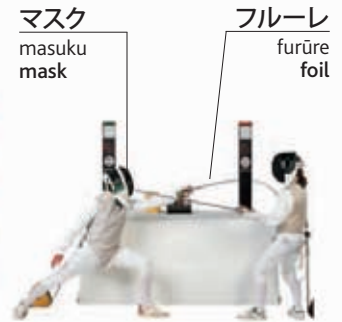

マスク
masuku
mask

フルーレ
furūre
foil

フェンシング
fenshingu
fencing

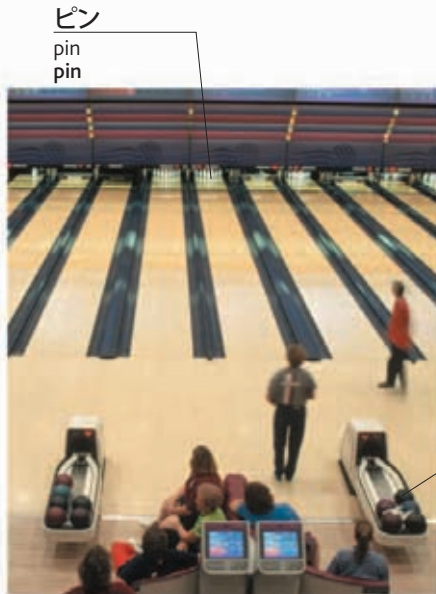

ピン
pin
pin

矢
ya
arrow

矢筒
yazutsu
quiver

ボウリング
bo'uringu
bowling

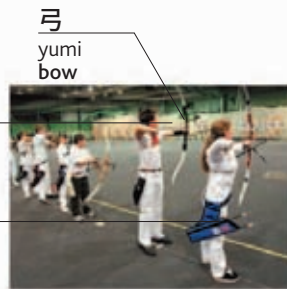

弓
yumi
bow

洋弓
yōkyū
archery



的
mato
target

ターゲット射撃
tāgetto shageki
target shooting



ボール
bōru
bowling ball

プール
pūru
pool



スヌーカー
sunūkā
snooker

フィットネス fittonesu • fitness

エアロバイク
earobaiku
exercise bike

フリーウェイト
furī weito
free weights

バー
bā
bar

フィットネス器具
fittonesu kigu
gym machine

ベンチ
benchi
bench



ローイングマシーン
rōingu mashīn
rowing machine

スポーツジム
supōtsu jimu
gym



トレッドミル
toreddomiru
treadmill



クロストレーナー
kurosu torēnā
cross trainer



パーソナルトレーナー
pāsonaru torēnā
personal trainer



ステッパー
suteppā
step machine

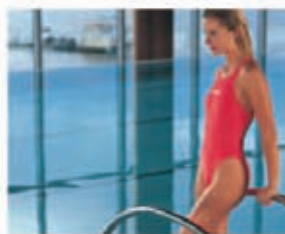

プール
pūru
swimming pool



サウナ
sauna
sauna

運動 undō • exercises



ストレッチ
sutoretchi
stretch



ランジ
ranji
lunge

タイツ
taitsu
tights



腕立て伏せ
udetatefuse
push-up



スクワット
sukuwatto
squat



腹筋運動
fukkin undō
sit-up



アームカール
āmu kāru
bicep curl

ダンベル
danberu
dumb bell



レッグプレス
reggu puresu
leg press



チェストプレス
chesuto puresu
chest press



スニーカー
sunikā
trainers

ウェイトトレーニング
weito torēningu
weight training

バーベル
bāberu
weight bar



ジョギング
jogingu
jogging

ランニングシャツ
ranningu shatsu
vest



エアロビクス
earobikusu
aerobics

関連用語 kanrenyōgo • vocabulary

トレーニングする
torēningu suru
train (v)

その場でジョギングする
sono ba de jogingu suru
run in place (v)

伸ばす
nobasu
extend (v)

ピラティス
piratisu
Pilates

サーキットトレーニング
sākitto torēningu
circuit training

準備運動をする
jumbi undō o suru
warm up (v)

動かす
ugokasu
flex (v)

懸垂する
kensui suru
pull up (v)

ボクササイズ
bokusasaizu
boxercise

縄跳び
nawatobi
skipping



娛樂 goraku
leisure

劇場 gekijō • theater



幕
maku
curtain

袖
sode
wings

セット
setto
set

観客
kankyaku
audience

オーケストラ
ōkesutora
orchestra

舞台 butai | stage

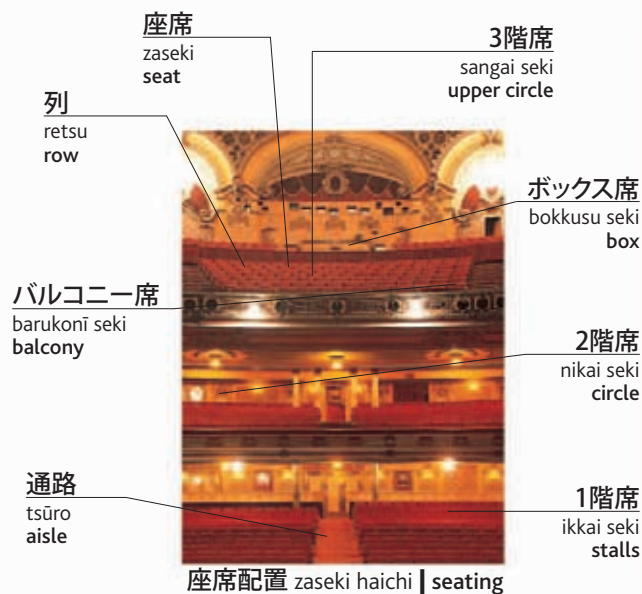

座席
zaseki
seat

3階席
sangai seki
upper circle

列
retsu
row

ボックス席
bokkusu seki
box

バルコニー席
barukonī seki
balcony

2階席
nikai seki
circle

通路
tsūro
aisle

1階席
ikkai seki
stalls

座席配置 zaseki haichi | seating

関連用語 kanrenyōgo • vocabulary

配役
haiyaku
cast

台本
daihon
script

初日
shonichi
first night

俳優
haiyū
actor

背景
haikai
backdrop

休憩時間
kyūkei jikan
interval

女優
joyū
actress

監督
kantoku
director

プログラム
puroguramu
program

劇
geki
play

プロデューサー
purodyūsā
producer

オーケストラピット
ōkesutora pitto
orchestra pit



音楽会 ongakukai | concert



ミュージカル myūjīkaru | musical

衣装
ishō
costume



バレエ barē | ballet

関連用語 kanrenyōgo • vocabulary

案内係
annai-gakari
usher

クラシック音楽
kurashikku ongaku
classical music

楽譜
gakufu
musical score

サウンドトラック
saundotorakku
soundtrack

拍手する
hakushu suru
applaud (v)

アンコール
ankōru
encore

今晚のチケットを2枚ください。
konban no chiketto o ni-mai kudasai.
I'd like two tickets for tonight's
performance.

何時に始まりますか。
nanji ni hajimarimasuka?
What time does it start?



オペラ opera | opera

映画 eiga • cinema

ポップコーン
poppukōn
popcorn



チケット売場
chiketto uriba
box office

ロビー
robī
lobby

ポスター
posutā
poster



映画館
eigakan
cinema hall



映写幕
eishamaku
screen

関連用語 kanrenyōgo • vocabulary

コメディ
komedi
comedy

スリラー
surirā
thriller

ホラー映画
horā eiga
horror movie

西部劇
seibugeki
western

恋愛物語
ren'ai monogatari
romance

SF映画
esu-efu eiga
science fiction movie

冒険
bōken
adventure

アニメ映画
anime eiga
animated movie

オーケストラ ōkesutora • orchestra

弦楽器 gengakki • strings



ピアノ piano | piano

楽譜
gakufu
score

へ音記号
heon kigō
bass clef

ト音記号
to'on kigō
treble clef

音符
ompu
note

五線譜
gosenfu
staff



記譜法 kifuhō | notation

関連用語 kanrenyōgo • vocabulary

序曲
jokyoku
overture

ソナタ
sonata
sonata

休止符
kyūshifu
rest

シャープ
shāpu
sharp

本位記号
hon'i kigō
natural

音階
onkai
scale

交響曲
kōkyōkyoku
symphony

楽器
gakki
instruments

ピッチ
pitchi
pitch

フラット
furatto
flat

小節
shōsetsu
bar

指揮棒
shikibō
baton

木管楽器 mokkan gakki • woodwind



ピッコロ
pikkoro
piccolo



フルート
furūto
flute



オーボエ
ōboe
oboe



イングリッシュホルン
ingurissu horun
English horn



サクソフォン
sakusofon
saxophone



クラリネット
kurarinetto
clarinet



バスクラリネット
basu kurarinetto
bass clarinet



ファゴット
fagotto
bassoon



コントラファゴット
kontora fagotto
double bassoon

打楽器 dagakki • percussion



ケトルドラム
ketorudoramu
kettledrum



銅鑼
dora
gong



ボンゴ
bongo
bongos



スネアドラム
sunea doramu
snare drum



シンバル
shimbaru
cymbals



タンバリン
tambarin
tambourine



ビブラフォン
biburafon
vibraphone



トライアングル
toraianguru
triangle



マラカス
marakasu
maracas

金管楽器 kinkan gakki • brass



トランペット
torampetto
trumpet



トロンボーン
toronbōn
trombone



フレンチホルン
furenchi horun
French horn



チューバ
chūba
tuba

コンサート konsāto • concert



マイク
maiku
microphone

リードシンガー
rīdo shingā
lead singer

ドラマー
doramā
drummer

ギタリスト
gitarisuto
guitarist

ファン
fan
fans

ベーシスト
bēshisuto
bass guitarist

スピーカー
supikā
speaker

ロックコンサート rokkū konsāto | rock concert

楽器 gakki • instruments

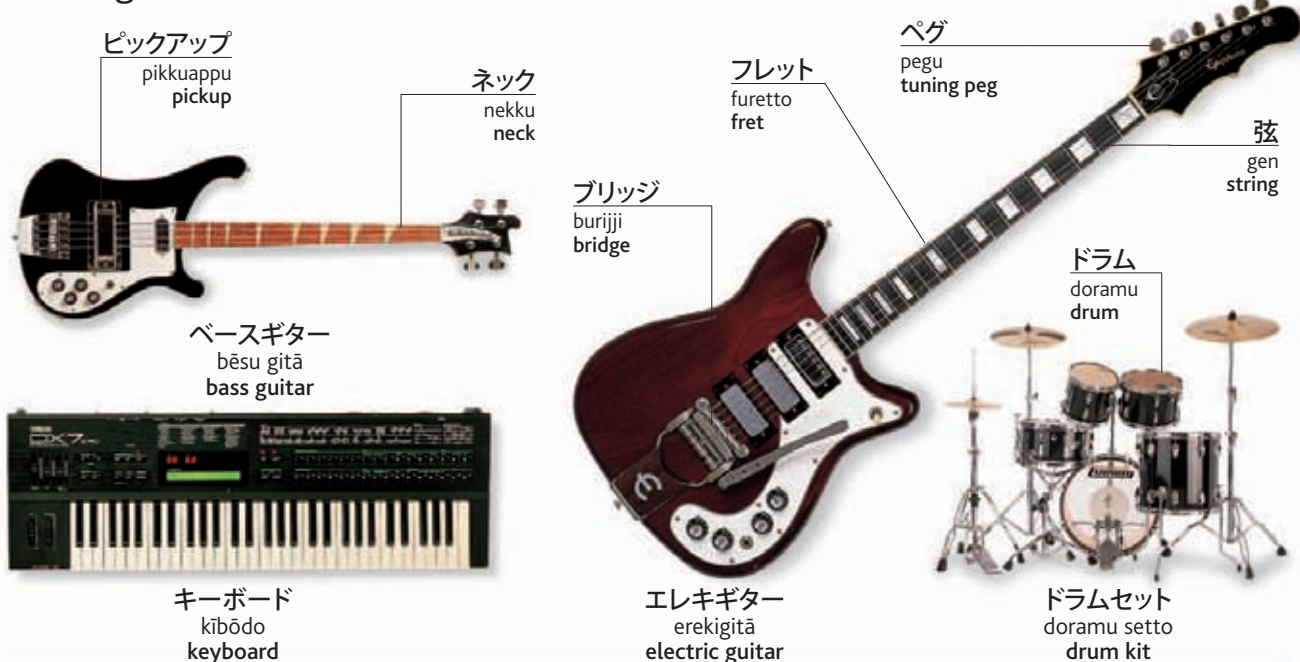

ピックアップ
pikkuappu
pickup

ネック
nekku
neck

フレット
furetto
fret

ペグ
pegu
tuning peg

弦
gen
string

ブリッジ
burijji
bridge

ベースギター
bēsu gitā
bass guitar

ドラム
doramu
drum

キーボード
kibōdo
keyboard

エレキギター
erekigitā
electric guitar

ドラムセット
doramu setto
drum kit

音楽ジャンル ongaku janru • music styles



ジャズ jazu | jazz



ブルース burūsu | blues



パンク panku | punk



フォーク fōku | folk music



ポップス poppusu | pop



ダンス dansu | dance



ラップ rappu | rap



ヘビーメタル hebī metaru
heavy metal



クラシック kurasshikku
classical music

関連用語 kanrenyōgo • vocabulary

歌
uta
song

歌詞
kashi
lyrics

メロディー
merodī
melody

ビート
bīto
beat

レゲエ
rege'e
reggae

カントリー
kantōri
country

スポットライト
supottoraito
spotlight

観光 kankō • sightseeing



観光客
kankō kyaku
tourist

観光名所 kankō meisho | tourist attraction



観光ルート
kankō rūto
itinerary

オープントップ
ōpun toppu
open top

観光バス kankō basu | tour bus

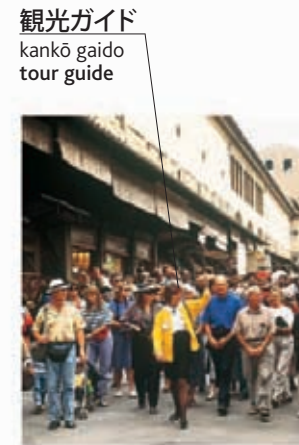

観光ガイド
kankō gaido
tour guide

ガイド付きツアー
gaido-tsuki tsuā
guided tour



小像
shōzō
statuette

土産物
miyagemono
souvenirs

関連用語 kanrenyōgo • vocabulary

開館
kaikan
open

観光案内書
kankō annaisho
guide book

カムコーダー
kamukōdā
camcorder

左
hidari
left

...は、どこですか。
... wa doko desuka?
Where is...?

閉館
heikan
closed

フィルム
firumu
movie

カメラ
kamera
camera

右
migi
right

道に迷ってしまいました。
michi ni mayotte shimaimashita.
I'm lost.

入場料
nyūjō-ryō
entrance fee

電池
denchi
batteries

行き方
ikikata
directions

まっすぐ
massugu
straight ahead

...への行き方を教えてください。
... e no ikikata o oshiete kudasai.
Can you tell me the way to...?

名所 meisho • attractions

絵画
kaiga
painting

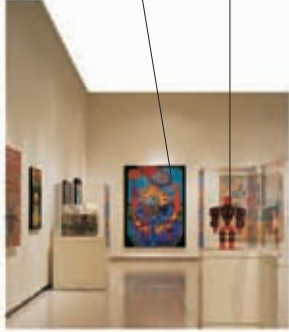

美術館
bijutsukan
art gallery

展示品
tenji-hin
exhibit



記念碑
kinenhi
monument

展覧会
tenrankai
exhibition



博物館
hakubutsukan
museum

旧跡
kyūseki
famous ruin



歴史的建造物
rekishi-teki kenzōbutsu
historic building



カジノ
kajino
casino



庭園
teien
gardens



国立公園
kokuritsu kōen
national park

案内 annai • information

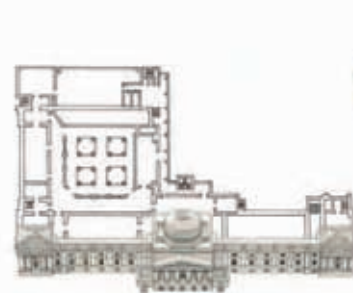

案内図
annai zu
floor plan



地図
chizu
map

時間
jikan
times



時刻表
jikokuhyō
timetable



観光案内所
kankō annai-jo
tourist information

野外活動 yagai katsudō • outdoor activities

歩道
hodō
footpath

日時計
hidokei
sundial

カフェ
kafe
café



公園 kōen | park

芝生
shibafu
grass

ベンチ
benchi
bench

平面幾何学式庭園
heimen kikagaku-shiki teien
formal gardens

ジェットコースター
jetto kōsutā
roller coaster



遊園地
yūenchi
fairground



テーマパーク
tēma pāku
theme park



サファリパーク
safari pāku
safari park



動物園
dōbutsuen
zoo

活動 katsudō • activities



サイクリング
saikuringu
bicycling



ジョギング
jogingu
jogging



スケートボード
sukētobōdo
skateboarding



ローラーブレード
rōrāburēdo
rollerblading

乗馬道
jōba-dō
bridle path



野鳥観察
yachō kansatsu
bird watching



乗馬
jōba
horseback riding



ハイキング
haikingu
hiking

バスケット
basuketto
hamper



ピクニック
pikunikku
picnic

遊び場 asobiba • playground



砂場
sunaba
sandpit



水浴びプール
mizuabi pūru
paddling pool



ブランコ
buranko
swings



シーソー shīsō | seesaw



滑り台 suberidai | slide



ジャングルジム janguru jimu
climbing frame

海辺 umibe • beach

ホテル
hoteru
hotel

ビーチパラソル
bīchi parasoru
beach umbrella

海の家
umi no ie
beach hut

砂
suna
sand

波
nami
wave

海
umi
sea



ビーチバッグ
bīchi baggu
beach bag

ビキニ
bikini
bikini



日光浴をする nikkōyoku o suru | sunbathe (v)



監視塔
kanshitō
lifeguard tower

監視員
kanshi'in
lifeguard



防風フェンス
bōfū fensu
windbreak



遊歩道
yūhodō
promenade



デッキチェア
dekki chea
deck chair



サングラス
sangurasu
sunglasses



日除け帽
hiyoke-bō
sun hat



日焼けローション
hiyake rōshon
suntan lotion



日焼け止め
hiyakedome
sunblock



ビーチボール
bīchi bōru
beach ball



浮き輪
ukiwa
rubber ring

水着
mizugi
swimsuit

シャベル
shaberu
shovel

バケツ
baketsu
bucket

砂の城
suna no shiro
sandcastle

貝殻
kaigara
shell



ビーチタオル
bīchi taoru
beach towel

キャンプ kyampu • camping



トイレ
toire
toilets

ゴミ置場
gomi okiba
waste disposal

シャワー棟
shawā tō
shower block

電源装置
dengen sōchi
electric hook-up

フライシート
furaishīto
flysheet

ペグ
pegu
tent peg

ロープ
rōpu
guy rope

キャンピングトレーラー
kyāmpingu torērā
camper

キャンプ場 kyāmpujō | campsite

関連用語 kanrenyōgo • vocabulary

キャンプする
kyampu suru
camp (v)

サイト
saito
pitch

ピクニックベンチ
pikunikku benchi
picnic bench

炭
sumi
charcoal

管理事務所
kanri jimusho
site manager's office

テントを張る
tento o haru
pitch a tent (v)

ハンモック
hāmmokku
hammock

着火剤
chakka-zai
firelighter

空きサイトあり
aki saito ari
pitches available

ポール
pōru
tent pole

キャンピングカー
kyāmpingu kā
camper van

火をつける
hi o tsukeru
light a fire (v)

空きなし
aki nashi
full

キャンプベッド
kyampu beddo
camp bed

トレーラー
torērā
trailer

キャンプファイヤー
kyāmpufaiyā
campfire



娯楽家電 goraku kaden • home entertainment



ポータブルCDプレーヤー
pōtaburu shī-dī purēyā
personal CD player



ミニディスクレコーダー
mini disuku rekōdā
mini disk recorder



MP3プレーヤー
emu-pī-surī purēyā
MP3 player

DVDディスク
dī-bui-dī disuku
DVD disk



DVDプレーヤー
dī-bui-dī purēyā
DVD player

CDプレーヤー
shī-dī purēyā
CD player

ラジオ
rajio
radio

アンプ
ampu
amplifier

ヘッドホン
heddohon
headphones

スタンド
sutando
stand



オーディオシステム ōdio shisutemu | hi-fi system

レコードプレーヤー
rekōdo purēyā
record player

(ラウド)スピーカー
(raudo) supikā
(loud) speaker



スピーカースタンド
supikā sutando
speaker stand

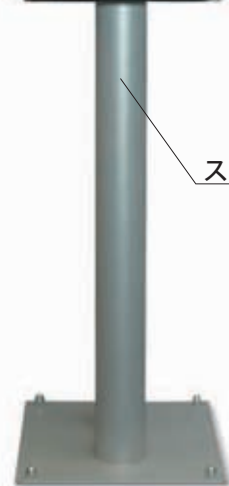



ビデオテープ
bideo tēpu
video tape

ビデオレコーダー
bideo rekōdā
video recorder



画面
gamen
screen

カムコーダー
kamukōdā
camcorder

アイカップ
aikappu
eyecup



衛星アンテナ
eisei antena
satellite dish

ワイド画面テレビ
waido gamen terebi
widescreen television



コントローラー
kontorōrā
controller

コンソール
konsōru
console



テレビゲーム terebi gēmu | video game

早送り
hayaokuri
fast forward

一時停止
ichijiteishi
pause

録画
rokuga
record



音量
onryō
volume

巻き戻し
makimodoshi
rewind

再生
saisei
play

停止
teishi
stop

リモコン rimokon | remote control

関連用語 kanrenyōgo • vocabulary

コンパクトディスク
kompakuto disuku
compact disk

長編映画
chōhen eiga
feature film

番組
bangumi
program

有料チャンネル
yūryō channeru
pay per view channel

テレビを見る
terebi o miru
watch television (v)

カセットテープ
kasetto tēpu
cassette tape

コマーシャル
komāsharu
advertisement

ステレオ
sutereo
stereo

チャンネルを替える
channeru o kaeru
change channel (v)

テレビを消す
terebi o kesu
turn the television off (v)

カセットプレーヤー
kasetto purēyā
cassette player

デジタル
dijitaru
digital

ケーブルテレビ
kēburu terebi
cable television

テレビを点ける
terebi o tsukeru
turn the television
on (v)

ラジオをつける
rajio o tsukeru
tune the radio (v)

写真 shashin • photography

フィルムカウンター
firumu kauntā
frame counter

内蔵フラッシュ
naizō furasshu
flash

露出補正ダイヤル
roshutsu hosei daiyaru
aperture dial

シャッター
shattā
shutter release

シャッター速度摘み
shattā sokudo tsumami
shutter-speed dial



フィルター
firutā
filter



レンズキャップ
renzu kyappu
lens cap

レンズ
renzu
lens



三脚
sankyaku
tripod

一眼レフカメラ ichigan-refu kamera | SLR camera



フラッシュガン
furasshu gan
flash gun



露出計
roshutsukei
light meter



ズームレンズ
zūmu renzu
zoom lens

カメラの種類 kamera no shurui • types of camera



デジタルカメラ
dejitaru kamera
digital camera



APSカメラ
ē-pī-esu kamera
APS camera



インスタントカメラ
insutanto kamera
instant camera



使い捨てカメラ
tsukaisute kamera
disposable camera

写真撮影 shashin satsuei • photograph



スプール
supūru
film spool

フィルム
firumu
film



ピントを合わせる
pinto o awaseru
focus (v)



現像する
genzō suru
develop (v)



ネガ
nega
negative

ランドスケープ
randosukēpu
landscape



写真 shashin | photograph

ポートレート
pōtorēto
portrait



アルバム
arubamu
photo album



写真用額縁
shashin-yō gakubuchi
photo frame

問題 mondai • problems



露出不足
roshutsu-busoku
underexposed



露出オーバー
roshutsu-ōbā
overexposed



ピンぼけ
pimboke
out of focus



赤目
akame
red eye

関連用語 kanrenyōgo • vocabulary

ファインダー
faindā
viewfinder

印画
inga
print

カメラケース
kamera kēsu
camera case

無光沢
mukōtaku
matte

露出
roshutsu
exposure

光沢
kōtaku
gloss

暗室
anshitsu
darkroom

引き伸ばし
hikinobashi
enlargement

メモ리카ード
memori kādo
memory card

印画紙
ingashi
photo paper

このフィルムを現像してください。
kono firumu o genzō shite kudasai.
I'd like this film processed.

ゲーム gēmu • games

チェス盤
chesuban
chessboard

黒
kuro
black

白
shiro
white

クイーン
kuin
queen

キング
kingu
king

ポーン
pōn
pawn

ナイト
naito
knight

ビショップ
bishoppu
bishop

ルーク
rūku
rook

升目
masume
square

チェス
chesu
chess

駒
koma
tile

駒
koma
piece

スクラブル
sukuraburu | scrabble

チェッカー
chekkā
checkers

さいころ
saikoro
dice

駒
koma
counter

モノポリー
monopoli
monopoly

バックギャモン
bakkugyamon | backgammon

盤上ゲーム
banjō gēmu | board games



切手収集 kitte shūshū
stamp collecting



ジグソーパズル jigusō pazuru
jigsaw puzzle

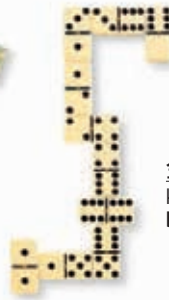

ドミノ domino
dominoes

ダーツボード
datsubōdo
dartboard

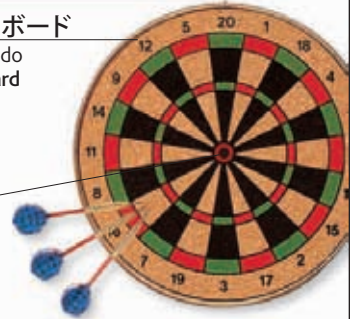

金的
kinteki
bullseye

ダーツ dātsu | darts

ジョーカー
jōkā
joker

ジャック
jakku
jack

クイーン
kuin
queen

キング
kingu
king

エース
ēsu
ace

トランプ torampu | cards



ダイヤ
daiya
diamond

スペード
supēdo
spade

ハート
hāto
heart

クラブ
kurabu
club

切る kiru | shuffle (v)

配る kubaru | deal (v)



関連用語 kanrenyōgo • vocabulary

手
te
move

勝つ
katsu
win (v)

敗者
haisha
loser

点
ten
point

ブリッジ
burijji
bridge

さいころを転がしてください。
saikoro o korogashite kudasai.
Roll the dice.

遊ぶ
asobu
play (v)

勝者
shōsha
winner

ゲーム
gēmu
game

得点
tokuten
score

トランプ一組
torampu hito-kumi
deck of cards

誰の番ですか。
dare no ban desuka?
Whose turn is it?

プレーヤー
purēyā
player

負ける
makeru
lose (v)

賭け
kake
bet

ポーカー
pōkā
poker

スーツ
sūto
suit

貴方の番です。
anata no ban desu.
It's your move.

美術と工芸1 bijutsu to kōgei • arts and crafts 1



画家
gaka
artist

絵
e
painting

イーゼル
īzeru
easel

キャンバス
kyambasu
canvas

絵筆
efude
brush

パレット
paretto
palette

図画 zuga | painting

絵具 enogu • paints



油絵具
abura enogu
oil paints



水彩絵具
suisai enogu
watercolor paint



パステル
pasuteru
pastels



アクリル絵具
akuriru enogu
acrylic paint



ポスターカラー posutā karā
poster paint

色 iro • colours



赤 aka | red



青 ao | blue



黄色 ki'iro
yellow



緑 midori | green



オレンジ色 orenji iro
orange



紫 murasaki
purple



白 shiro | white



黒 kuro | black



灰色 hai'iro | gray



ピンク pinku
pink



茶色 chairo | brown



藍色 ai'iro
indigo

他の工芸 ta no kōgei • other crafts

スケッチブック
suketchi bukku
sketch pad

鉛筆
empitsu
pencil

スケッチ
suketchi
sketch

インク
inku
ink

木炭
mokutan
charcoal

素描 sobyō | drawing



版画 hanga | printing



エッチング etching
engraving

石材
sekizai
stone

木槌
kizuchi
mallet

彫刻刀
chōkokutō
chisel

木材
mokuzai
wood

彫刻
chōkoku
sculpting

木工
mokkō
woodworking



成形道具
seikei dōgu
modeling tool

ロクロ
rokuro
potter's wheel

陶芸 tōgei | pottery

糊
nori
glue

厚紙
atsugami
cardboard

粘土
nendo
clay

コラージュ korāju | collage



ジュエリー制作
juerī seisaku
jewellery making



張子
hariko
papier-mâché



折り紙
origami
origami



模型制作
mokei seisaku
model making

美術と工芸2 bijutsu to kōgei • arts and crafts 2



ミシン mishin | sewing machine



鋏
hasami
scissors



型紙
katagami
pattern



針刺し
harisashi
pincushion

待針
nachibari
pin

裁縫箱 saihō-bako
sewing basket



メジャー
mejā
tape measure



生地
kiji
material



ボビン
bobin
bobbin



糸
ito
thread



受け金
ukegane
eye

受け金
ukegane
eye



指貫
yubinuki
thimble



チャコ
chako
tailor's chalk



ダミー
dami
tailor's dummy



糸を通す
ito o tōsu
thread (v)



縫い目
nuime
stitch

縫う
nu'u
sew (v)



繕う
tsukurō
darn (v)



仮縫いする
karinui suru
tack (v)



切る
kiru
cut (v)



ニードルポイント
nidorupointo
needlepoint



刺繍
shishū
embroidery



かぎ針
kagibari
crochet hook

かぎ針編み
kagibariami
crochet



マクラメ
makurame
macramé



パッチワーク
patchiwāku
patchwork



キルティング
kirutingu
quilting



レース用ボビン
rēsu-yō bobin
lace bobbin

レース編み
rēsuami
lace-making



機
hata
loom

機織り
hataori
weaving



編み針
amibari
knitting needle

編み物 amimono | knitting



毛糸
keito
wool

かせ kase | skein

関連用語 kanrenyōgo •
vocabulary

ほどく
hodoku
unpick (v)

ナイロン
nairon
nylon

布地
nunoji
fabric

絹
kinu
silk

綿
men
cotton

デザイナー
dezainā
designer

リネン
rinen
linen

ファッション
fashon
fashion

ポリエステル
poriesuteru
polyester

ファスナー
fasunā
zip





環境 kankyō
environment



宇宙空間 uchūkūkan • space

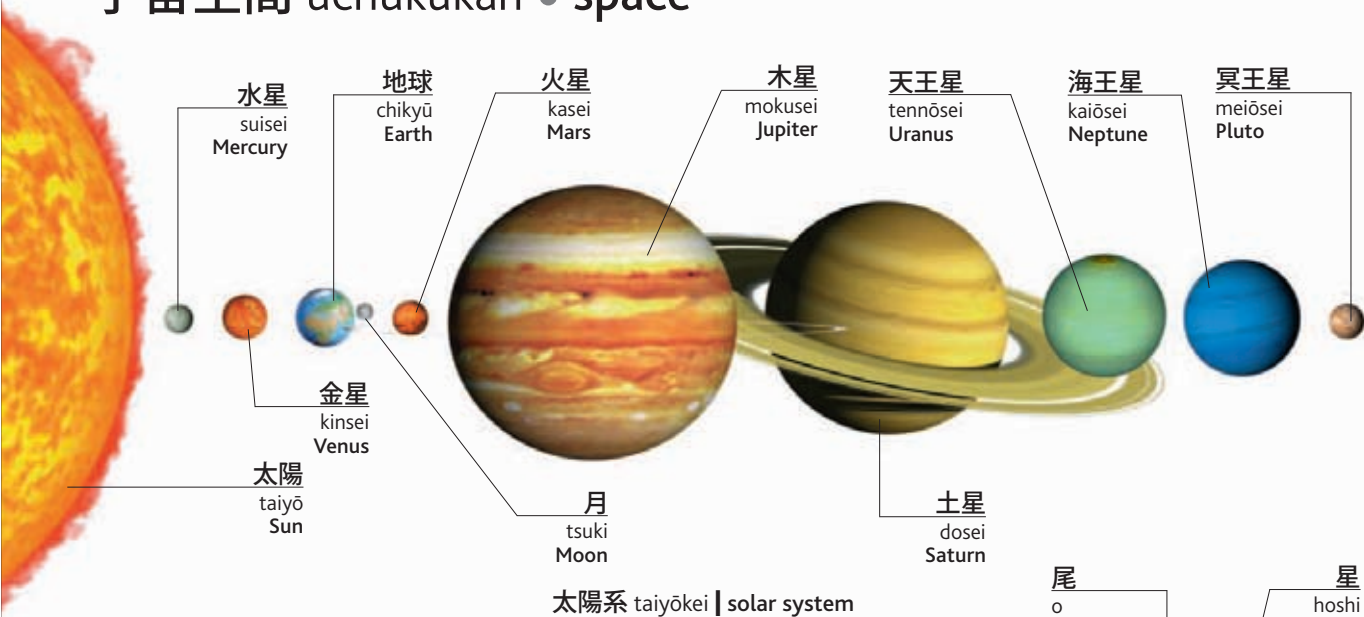

銀河系
gingakei
galaxy

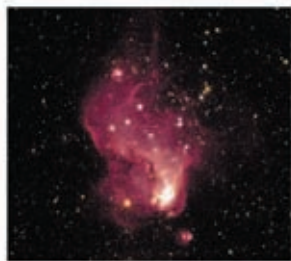

星雲
seiun
nebula



小惑星
shōwakusei
asteroid



彗星
suisei
comet

関連用語 kanrenyōgo • vocabulary

宇宙 uchū universe	ブラックホール burakku hōru black hole	満月 mangetsu full moon
軌道 kidō orbit	惑星 wakusei planet	新月 shingetsu new moon
重力 jūryoku gravity	流星 ryūsei meteor	三日月 mikazuki crescent moon



食 shoku | eclipse

宇宙探検 uchū tanken • space exploration

スペースシャトル
supēsu shatoru
space shuttle

ブースター
būsutā
booster



発射
hassha
launch

宇宙服
uchūfuku
space suit



宇宙飛行士 uchūhikōshi
astronaut

スラスタ
surasutā
thruster

発射台
hasshadai
launch pad

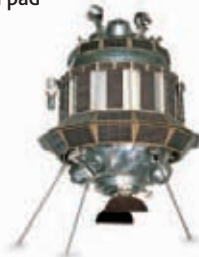

人工衛星
jinkōeisei
satellite

レーダー
rēdā
radar

乗船口
jōsen-guchi
crew hatch

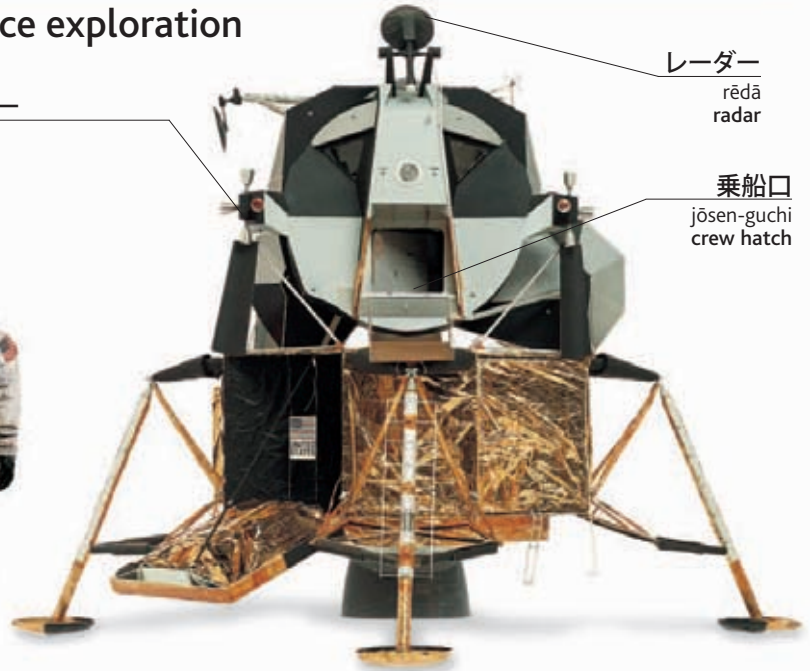

月着陸船 tsukichakurikusen | lunar module



宇宙ステーション
uchū sutēshon
space station

天文学 tenmongaku • astronomy



星座
seiza
constellation



双眼鏡
sōgankyō
binoculars

天体望遠鏡
tentaibōenkyō
telescope

三脚
sankyaku
tripod

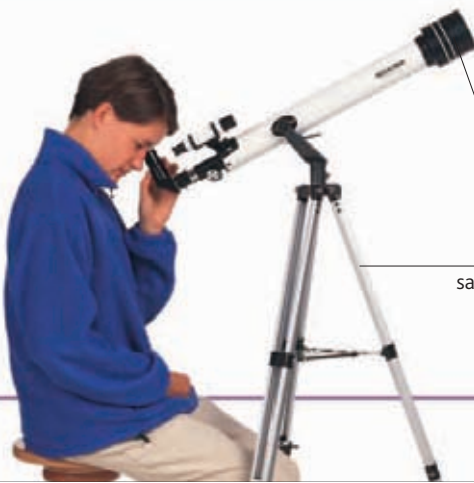

地球 chikyū • Earth

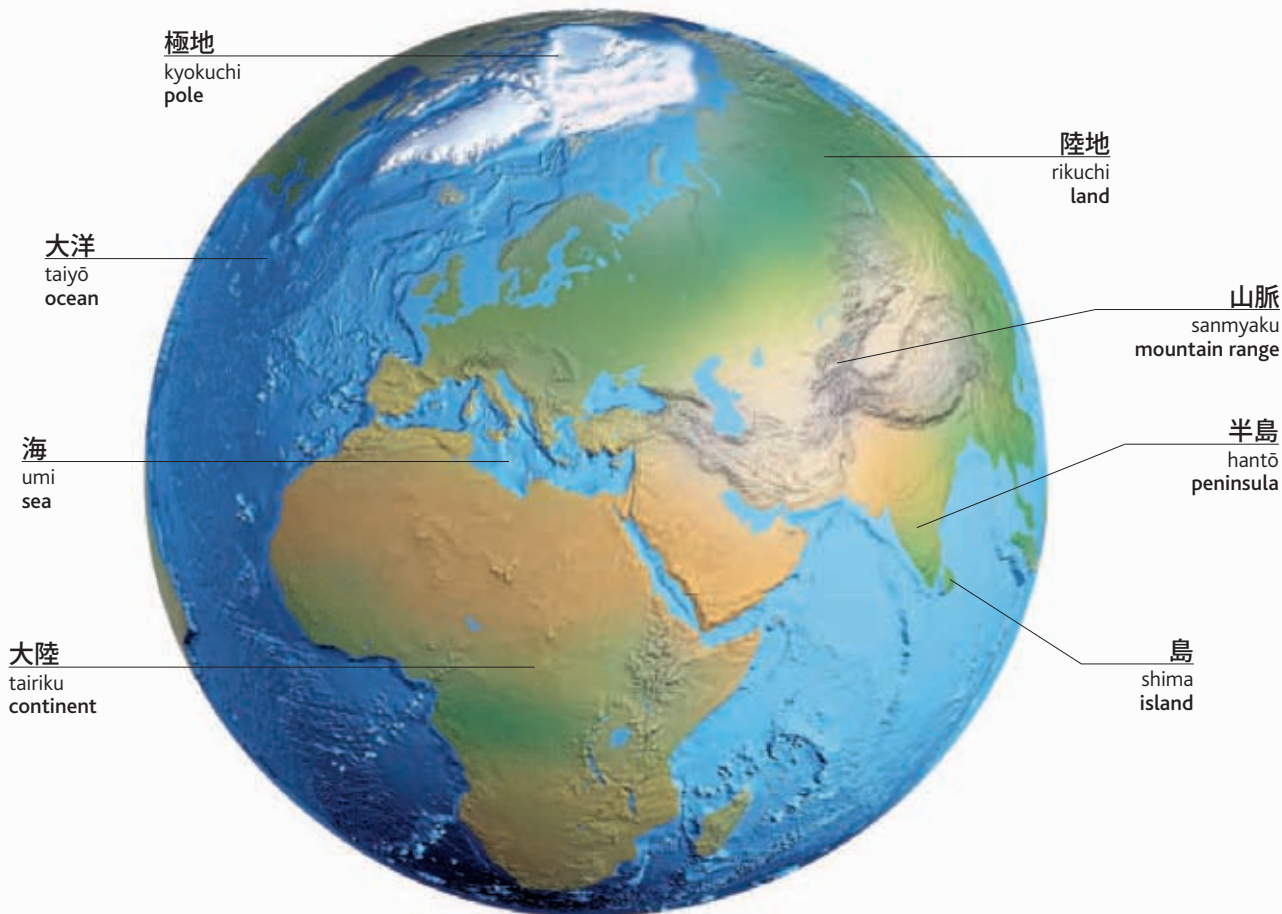

惑星 wakusei | planet

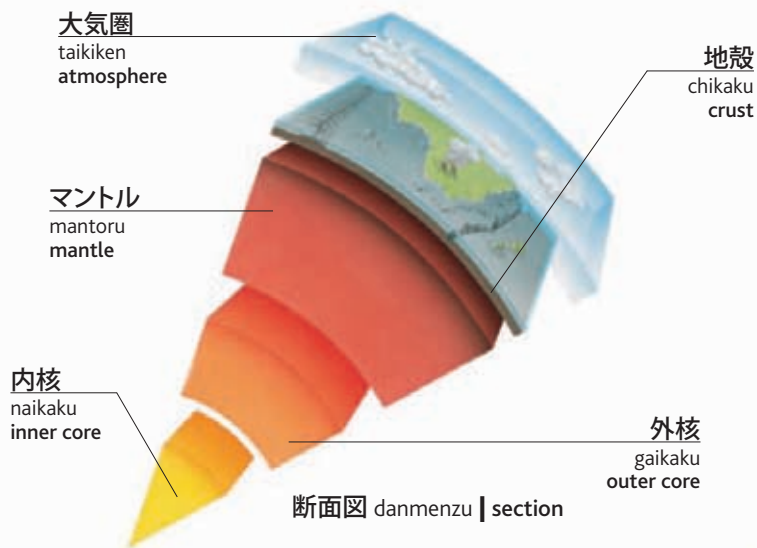

北極圏
hokkyokuken
Arctic Circle

北回帰線
kita kaikisen
Tropic of Cancer

熱帯
nettai
tropics

南回帰線
minami kaikisen
Tropic of Capricorn

溶岩
yōgan
lava

火山灰
kazambai
ash

マグマ溜まり
maguma damari
chamber

火山 kazan | volcano

火道
kadō
vent

マグマ
maguma
magma

噴火口 funkakō | crater

地帯 chitai | zones



北極
hokkyoku
North pole

北半球
kita hankyū
Northern Hemisphere

経度
keido
longitude

緯度
ido
latitude

南半球
minami hankyū
Southern Hemisphere

赤道
sekidō
equator

関連用語
kanrenyōgo •
vocabulary

地震
jishin
earthquake

プレート
purēto
plate

噴火する
funka suru
erupt (v)

微震
bishin
tremor



地勢 chisei • landscape

山
yama
mountain

斜面
shamen
slope

川岸
kawagishi
bank

川
kawa
river

急流
kyūryū
rapids

岩
iwa
rocks



氷河
hyōga
glacier



谷間 tanima | valley



丘陵
kyūryō
hill



台地
daichi
plateau



溪谷
keikoku
gorge



洞窟
dōkutsu
cave



平野 heiya | plain



砂漠 sabaku | desert



森林 shinrin | forest



林地 rinchi | wood



雨林
urin
rain forest



湿地
shitchi
swamp



草地
kusachi
meadow



草原
sōgen
grassland



滝
taki
waterfall



溪流
keiryū
stream



湖
mizu'umi
lake



間欠泉
kanketsusen
geyser



海岸
kaigan
coast



崖
gake
cliff



珊瑚礁
sangoshō
coral reef



河口
kakō
estuary

気象 kishō • weather

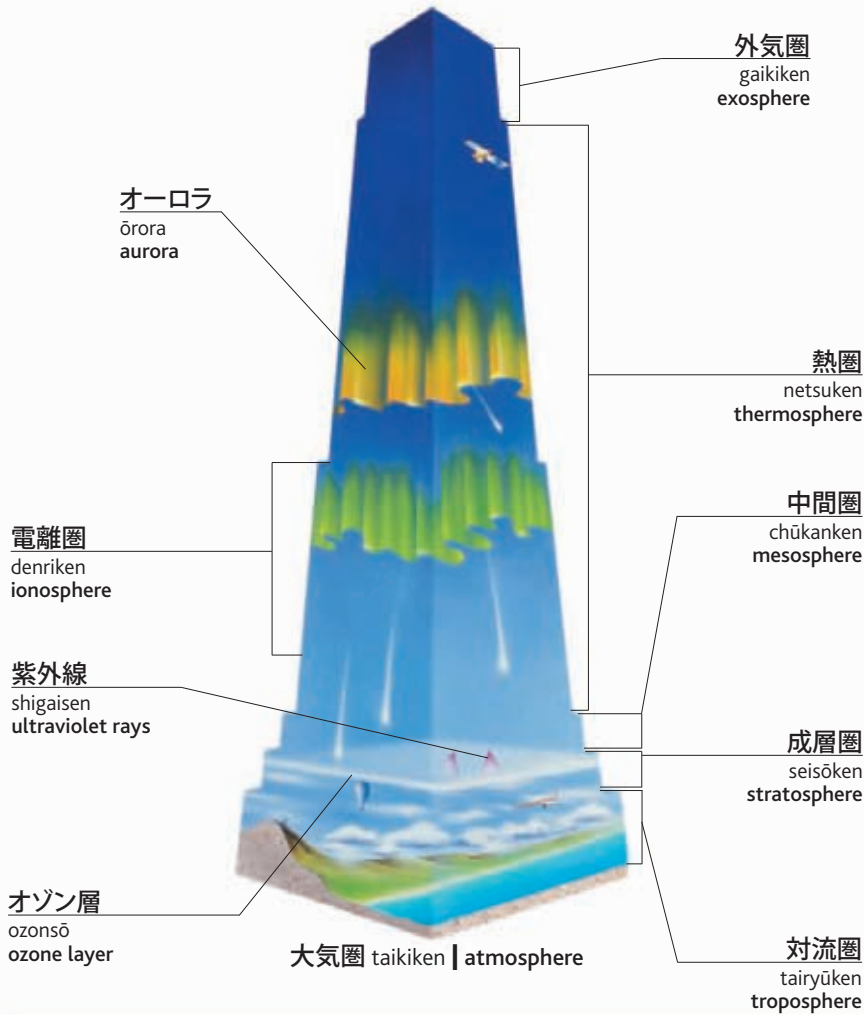

晴天 seiten | sunshine



風 kaze | wind

関連用語 kanrenyōgo • vocabulary

霰
mizore
sleet

晴れ
hare
sunny

寒い
samui
cold

雨がちな
ame-gachi na
wet

強風
kyōfū
gale

暑い/寒いです。
atsui/samui desu.
I'm hot/cold.

雹
hyō
hail

曇り
kumori
cloudy

暖かい
ataatai
warm

湿気が多い
shikke no ōi
humid

気温
kion
temperature

雨が降っています。
ame ga futte imasu.
It's raining.

雷
kaminari
thunder

暑い
atsui
hot

乾燥した
kansō
shita
dry

風の強い
kaze no
tsuyoi
windy

台風
taifū
typhoon

... 度です。
... do desu.
It's ... degrees.



雲 kumo | cloud



雨 ame | rain



稲妻
inazuma
lightning

嵐 arashi | storm



靄 moya | mist



霧 kiri | fog



虹 niji | rainbow



雪 yuki | snow



霜 shimo | frost



氷 kōri | ice



氷柱
tsurara
icicle

氷結 hyōketsu | freeze



ハリケーン harikēn
hurricane



旋風 tsumujikaze
tornado



モンスーン monsun
monsoon



洪水 kōzui | flood

岩石 ganseki • rocks

火成岩 kaseigan • igneous



花崗岩
kakōgan
granite



黒曜石
kokuyōseki
obsidian



玄武岩
gembagan
basalt



軽石
karuishi
pumice

堆積岩 taisekigan • sedimentary



砂岩
sagan
sandstone



石灰岩
sekkaigan
limestone



白亜
hakua
chalk



燧石
suiseki
flint



礫岩
rekigan
conglomerate



石炭
sekitan
coal

変成岩 henseigan • metamorphic



粘板岩
nembangan
slate



片岩
hengan
schist



片麻岩
henmagan
gneiss



大理石
dairiseki
marble

宝石 hōseki • gems

ルビー
rubī
ruby



アクアマリン
akuamarin
aquamarine



アメジスト
amejisuto
amethyst



ダイヤモンド
daiyamondo
diamond



翡翠
hisui
jade



ジェット
jetto
jet



エメラルド
emerarudo
emerald



オパール
opāru
opal



サファイア
safaiia
sapphire



ムーンストーン
mūnsutōn
moonstone



ガーネット
gānetto
garnet



トパーズ
topāzu
topaz



トルマリン
torumarin
tourmaline



鉱石 kōseki • minerals



石英
sekiei
quartz



雲母
unmo
mica



硫黄
iō
sulfur



ヘマタイト
hemataito
hematite



方解石
hōkaiseki
calcite



孔雀石
kujakuseki
malachite



トルコ石
torukoishi
turquoise



縞瑪瑙
shimamenō
onyx



瑪瑙
menō
agate



黒鉛
kokuen
graphite

金属 kinzoku • metals



金
kin
gold



銀
gin
silver



プラチナ
purachina
platinum



ニッケル
nikkeru
nickel



鉄
tetsu
iron



銅
dō
copper



錫
suzu
tin

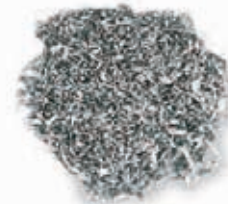

アルミニウム
aruminiumu
aluminum



水銀
suigin
mercury



亜鉛
aen
zinc

動物1 dōbutsu • animals 1

哺乳類 honyūruī • mammals



兎
usagi
rabbit



ハムスター
hamusutā
hamster

髭
hige
whiskers



二十日鼠
hatsukanezumi
mouse



尾
o
tail

鼠
nezumi
rat



針鼠
harinezumi
hedgehog



栗鼠
risu
squirrel



蝙蝠
kōmori
bat



狸
tanuki
raccoon



狐
kitsune
fox



狼
ōkami
wolf

子犬
koinu
puppy



犬
inu
dog

子猫
koneko
kitten



猫
neko
cat

子海豹
ko-azarashi
pup



獺
kawauso
otter



海豹
azarashi
seal



海驢
ashika
sea lion

ひれ足
hire ashi
flipper



海象
seiuchi
walrus

噴気孔
funkikō
blowhole



鯨
kujira
whale



海豚
iruka
dolphin



鹿
shika
deer

枝角
eda tsuno
antler

鬃
tategami
mane

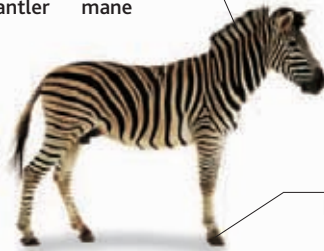

縞馬
shimauma
zebra

蹄
hizume
hoof



麒麟
kirin
giraffe



こぶ
kobu
hump

駱駝
rakuda
camel



河馬
kaba
hippopotamus

鼻
hana
trunk

牙
kiba
tusk



象
zō
elephant

角
tsuno
horn



犀
sai
rhinoceros



虎
tora
tiger

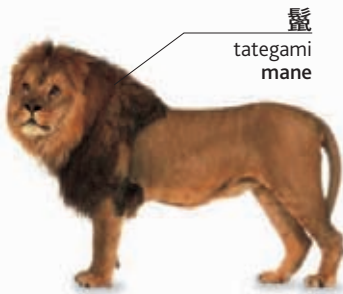

ライオン
raion
lion

鬃
tategami
mane



猿
saru
monkey



ゴリラ
gorira
gorilla



コアラ
koara
koala



カンガルー
kangarū
kangaroo

袋
fukuro
pouch



熊
kuma
bear

爪
tsume
claw



北極熊
hokkyokuguma
polar bear

パンダ
panda
panda



動物2 dōbutsu • animals 2

鳥類 chōrui • birds



カナリヤ
kanariya
canary



雀
suzume
sparrow



蜂鳥
hachidori
hummingbird



燕
tsubame
swallow



烏
karasu
crow



鳩
hato
pigeon



啄木鳥
kitsutsuki
woodpecker



隼
hayabusa
falcon



梟
fukurō
owl



鷗
kamome
gull

鷲
washi
eagle



ペリカン
perikan
pelican



フラミンゴ
furamingo
flamingo



鶴
kōnotori
stork



鶴
tsuru
crane



ペンギン
pengin
penguin



駝鳥
dachō
ostrich



鶯鳥 gachō | goose



白鳥 hakuchō swan



孔雀 kujaku peacock



雉 kiji pheasant



七面鳥 shichimenchō turkey



鸚哥 inko cockatoo

嘴 kuchibashi bill

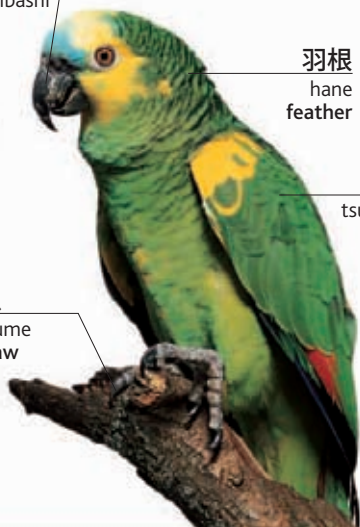

羽根 hane feather

翼 tsubasa wing

爪 tsume claw

鸚鵡 ōmu parrot

爬虫類 hachūruī • reptiles

鱗 uroko scales



アリゲーター arigētā alligator



蜥蜴 tokage lizard

イグアナ iguana iguana



亀 kame turtle



陸亀 riku-game tortoise

甲羅 kōra shell

蛇 hebi snake



鼻 hana snout



クロコダイル kurokodairu crocodile

動物3 dōbutsu • animals 3

両生類 ryōseirui • amphibians



蛙
kaeru
frog



蟾蛙
hikigaeru
toad



おたまじゃくし
otamajakushi
tadpole



山椒魚
sanshō'uo
salamander

魚類 gyorui • fish



鰻
unagi
eel

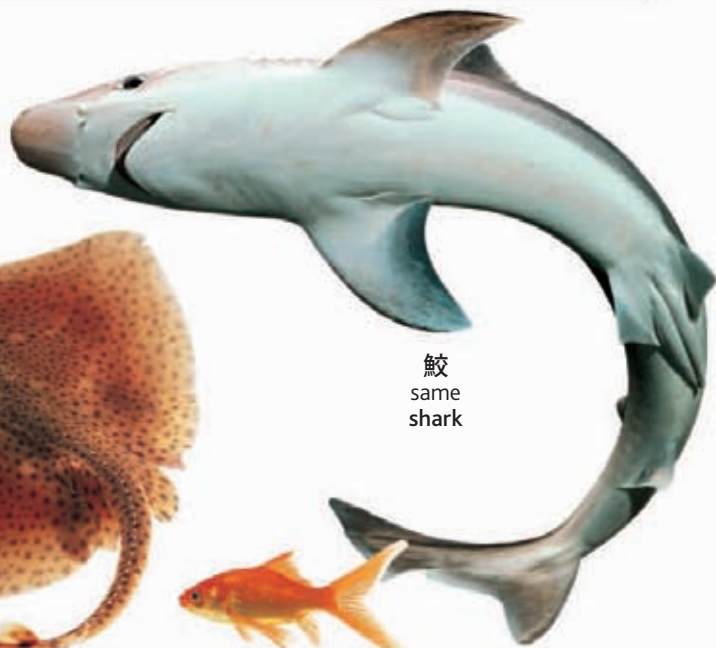

鮫
same
shark



竜の落とし子
tatsu-no-otoshigo
seahorse



雁木鱈
gangiei
skate

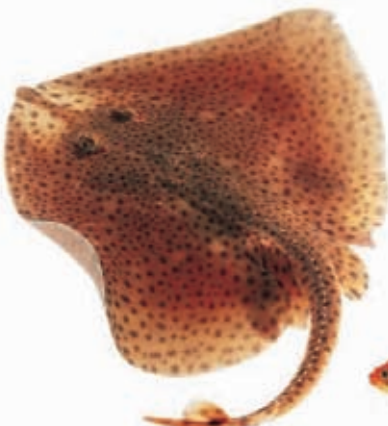

海鰻魚
ei
ray



金魚
kingyo
goldfish



女梶木 mekajiki | swordfish

背鰭
sebire
dorsal fin

胸鰭
munabire
pectoral fin

尾
o
tail

鰓
era
gill

鱗
uroko
scale

鯉 koi | koi carp

無脊椎動物 musekitsui dōbutsu • invertebrates



蟻
ari
ant



白蟻
shiroari
termite



蜜蜂
mitsubachi
bee



蜂
hachi
wasp



甲虫
kabutomushi
beetle



ゴキブリ
gokiburi
cockroach



蛾
ga
moth



蝶
chō
butterfly

触角
shokkaku
antenna



繭
mayu
cocoon



芋虫
imomushi
caterpillar



蟋蟀 kōrogi | cricket



蝗
inago
grasshopper



螳螂
kamakiri
praying mantis



毒針
dokubari
sting



百足
mukade
centipede



蜻蛉
tombo
dragonfly



蠅
hae
fly



蚊
ka
mosquito



天道虫
tentōmushi
ladybug



蜘蛛
kumo
spider



蛞蝓
namekuji
slug



蝸牛
katatsumuri
snail



蚯蚓 mimizu | worm



海星
hitode
starfish



紫貽貝
murasaki igai
mussel



蟹 kani | crab



ロブスター robusutā
lobster



蛸 tako | octopus



烏賊 ika | squid



水母 kurage | jellyfish

植物 shokubutsu • plants

木 ki • tree

枝
eda
branch

根
ne
root

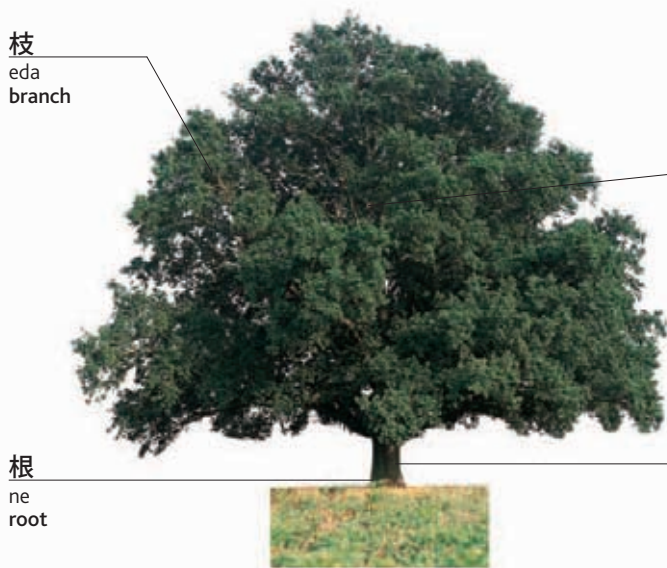

樅 kashi | oak



唐松
karamatsu
larch



ブナ
buna
beech



白樺
shirakaba
birch



楓
kaede
maple



榆
nire
elm



リンデン
rinden
linden



柊
hi'iragi
holly



葉
ha
leaf

小枝
koeda
twig

樹皮
juhi
bark

幹
miki
trunk



柳
yanagi
willow



ポプラ
popura
poplar



ユーカリ
yūkari
eucalyptus



松
matsu
pine



ヒマラヤ杉
himarayasugi
cedar



実
mi
berry

椰子
yashi
palm

顕花植物 kenkashokubutsu • flowering plant

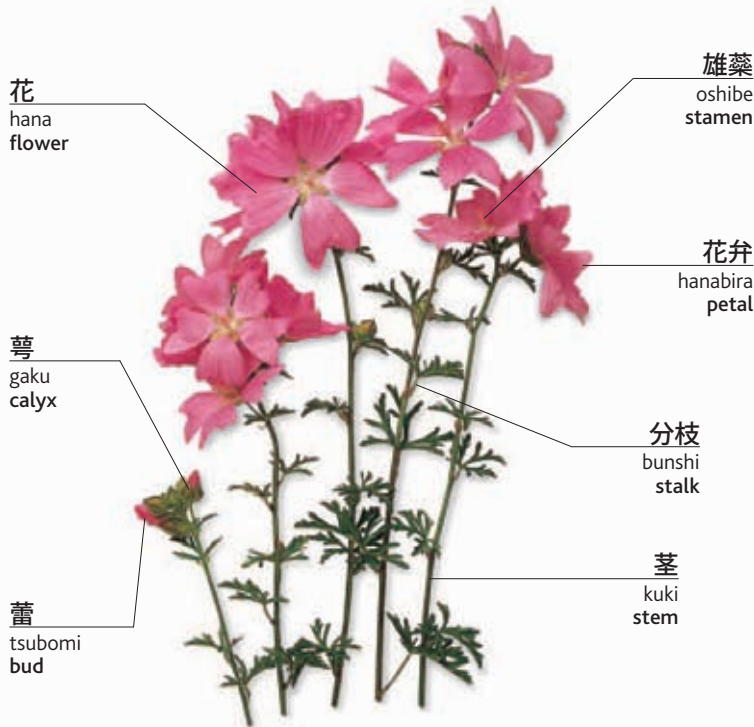

金鳳花
kimpōge
buttercup



雛菊
hinagiku
daisy



薊
azami
thistle



蒲公英
tampopo
dandelion



ヒース
hīsu
heather



芥子
keshi
poppy



狐の手袋
kitsune-no-tebukuro
foxglove



忍冬
suikazura
honeysuckle



向日葵
himawari
sunflower



クローバー
kurōbā
clover



釣鐘水仙
tsurigane suisen
bluebells



桜草
sakurasō
primrose



ルーピン
rūpin
lupins



刺草
irakusa
nettle

市街 shigai • town

通り
tōri
street

縁石
fuchi'ishi
curb

街角
machikado
street corner

商店
shōten
store



交差点
kōsaten
intersection

一方通行
ippōtsūkō
one-way street

歩道
hodō
pavement

オフィスビル
ofisu biru
office building

マンション
manshon
apartment
building

路地
roji
alley

駐車場
chūshajō
parking lot

道路標識
dōro hyōshiki
street sign

ポラード
borādo
traffic post

街灯
gaitō
street light

建物 tatemono • buildings



市庁舎
shichōsha
town hall



図書館
toshokan
library



映画館
eigakan
movie theater



劇場
gekijō
theater



大学
daigaku
university



摩天楼
matenrō
skyscraper

区域 kuiki • areas



工業団地
kōgyōdanchi
industrial complex



都市
toshi
city



学校
gakkō
school



郊外
kōgai
suburb



村
mura
village

関連用語 kanrenyōgo • vocabulary

歩行者天国
hokōsha-tengoku
pedestrian zone

脇道
wakimichi
side street

マンホール
manhōru
manhole

排水溝
haisuikō
gutter

教会
kyōkai
church

大通り
ōdōri
avenue

広場
hiroba
square

バス停
basutei
bus stop

工場
kōjō
factory

下水道
gesuidō
drain

建築 kenchiku • architecture

建物と構造 tatemono to kōzō • buildings and structures



摩天楼
matenrō
skyscraper



城
shiro
castle



教会
kyōkai
church

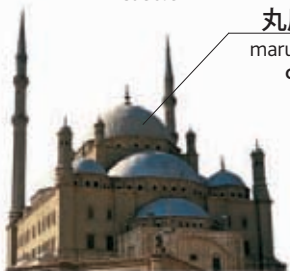

モスク
mosuku
mosque



寺院
ji'in
temple



シナゴーク
shinagōgu
synagogue



ダム
damu
dam



橋
hashi
bridge

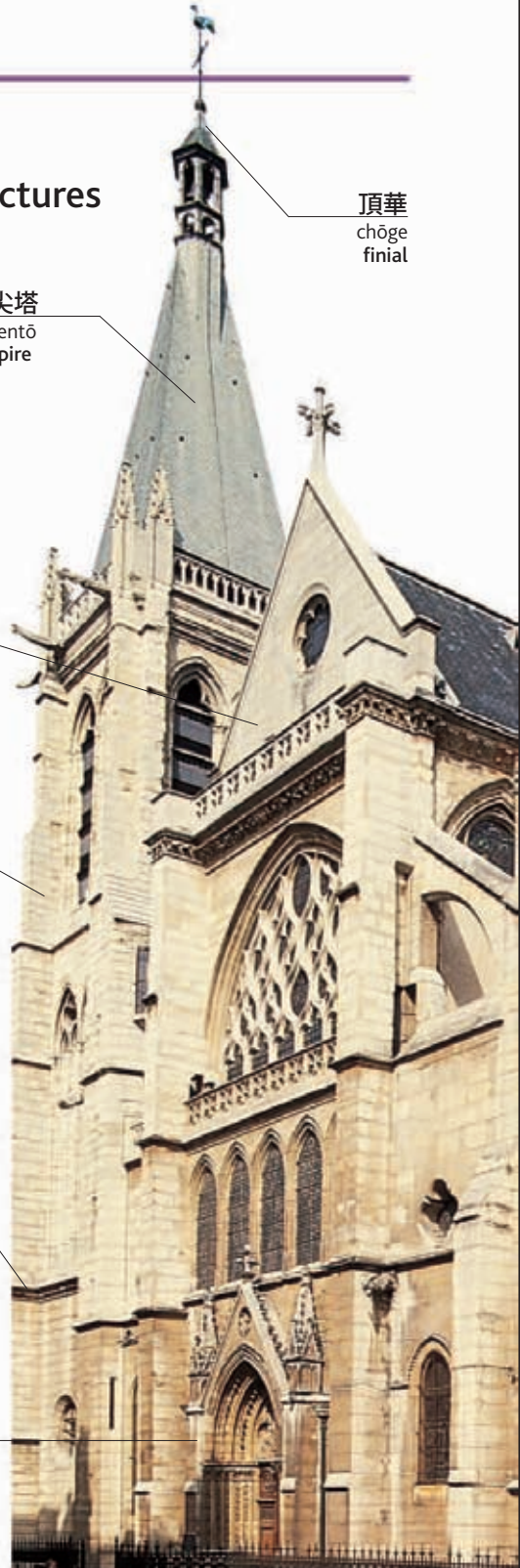

大聖堂 daiseidō | cathedral

頂華
chōge
finial

小塔 尖塔
shōtō sentō
turret spire

濠
hori
moat

破風
hafu
gable

丸屋根
maruyane
dome

塔
tō
tower

アーチ形屋根
āchi-gata yane
vault

コーニス
kōnisu
cornice

柱
hashira
pillar

建築様式 kenchiku yōshiki • styles



ゴシック goshikku | gothic

アーキトレーブ
ākitorēbu
architrave



ルネサンス
runesansu
Renaissance



バロック
barokku
baroque



アーチ
āchi
arch

フリーズ
furizu
frieze

聖歌隊席
seikatai seki
choir



ロココ
rokoko
rococo

ペディメント
pedimento
pediment



控え壁
hikaekabe
buttress

新古典主義
shinkotenshugi
neoclassical



アールヌーボー
āru nūbō
art nouveau



アールデコ
āru deko
art deco

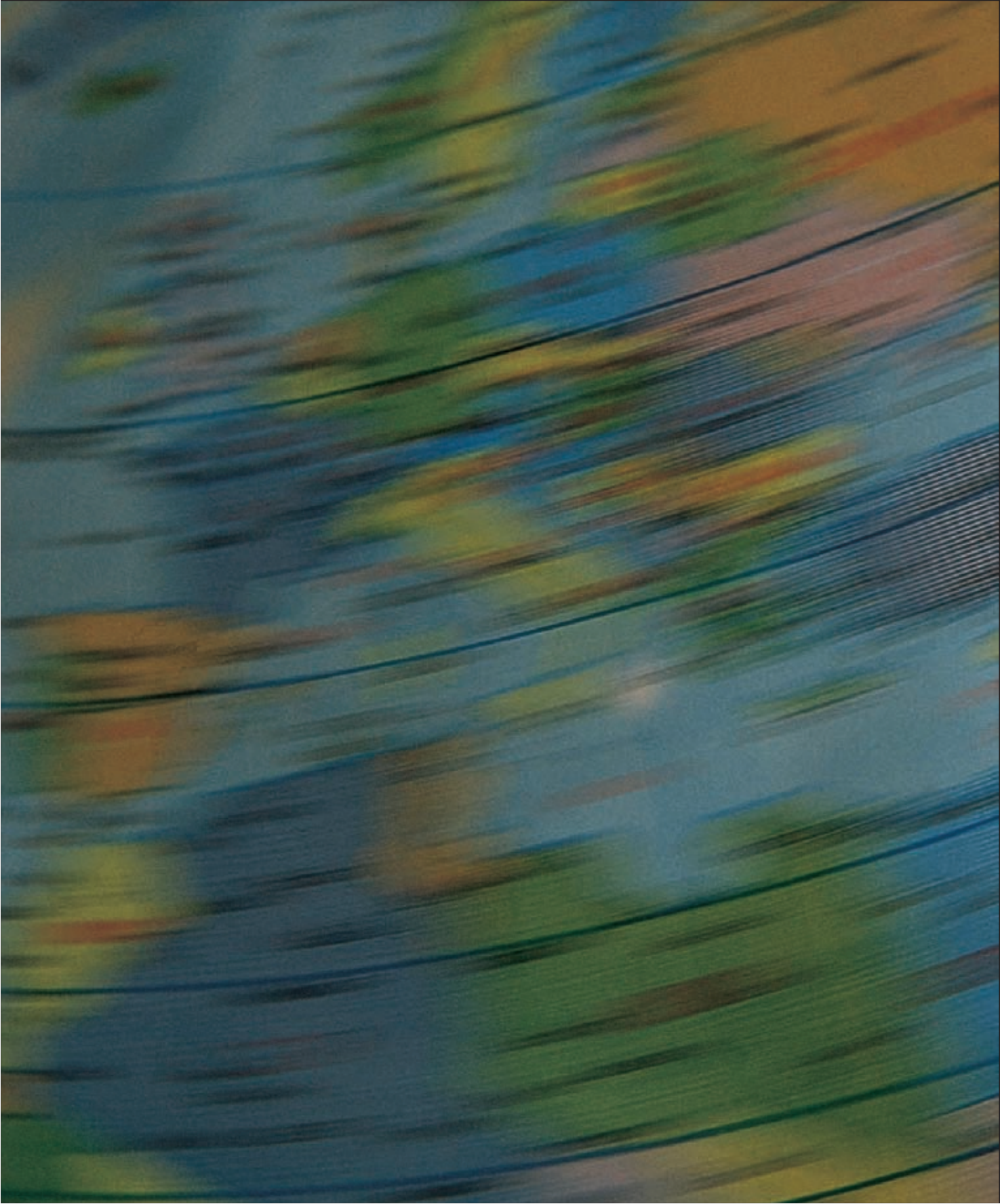

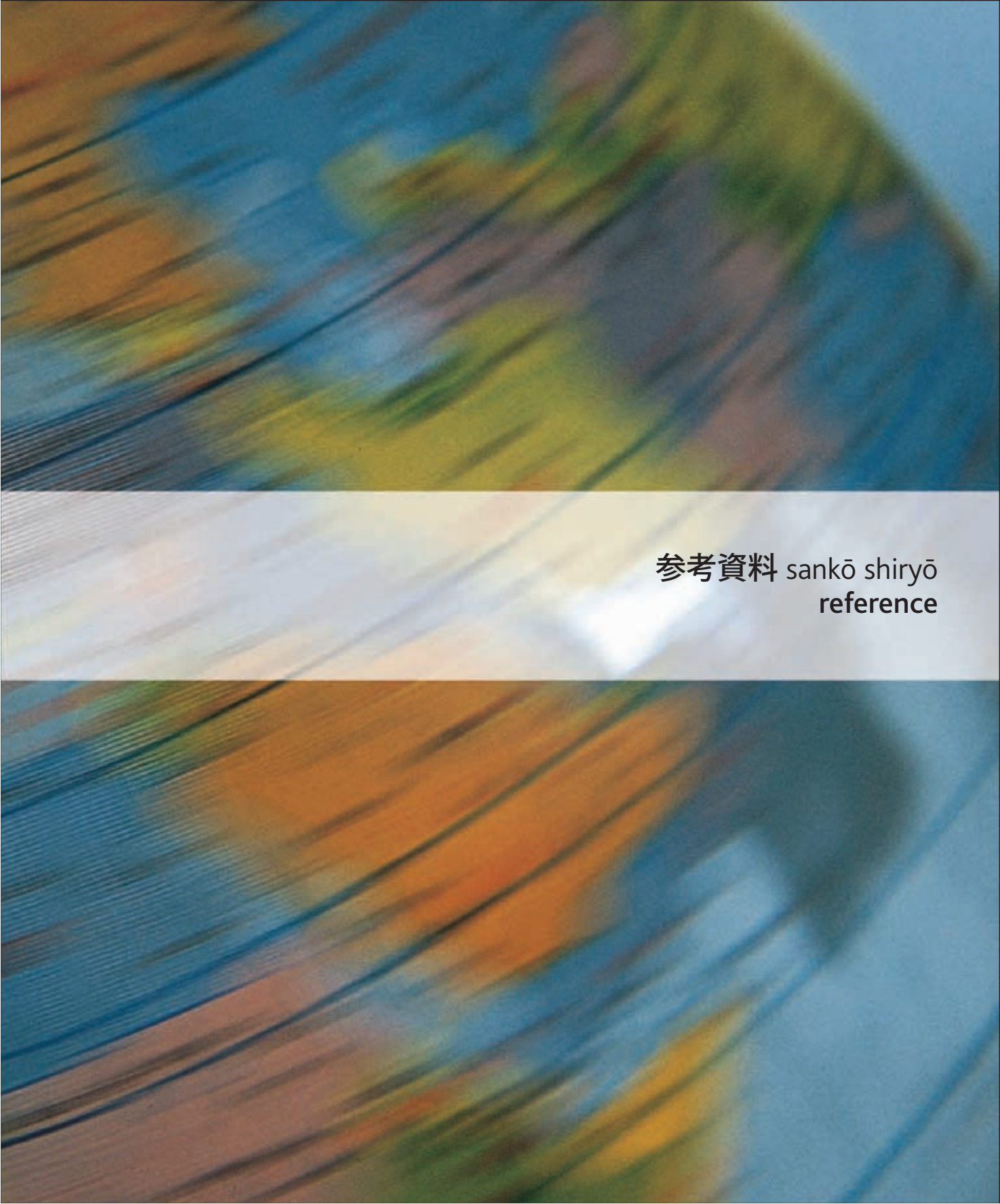

参考資料 sankō shiryō
reference

時間 jikan • time

長針
chōshin
minute hand

短針
tanshin
hour hand



時計
tokei
clock

関連用語 kanrenyōgo • vocabulary

秒 byō second	現在 genzai now	15分 jūgo-fun a quarter of an hour
分 fun minute	後 nochi later	20分 nijūppun twenty minutes
時 ji hour	30分 sanjūppun half an hour	40分 yonjūppun forty minutes

今、何時ですか。
ima nanji desuka?
What time is it?

3時です。
san-ji desu.
It's three o'clock.



1時5分
ichi-ji go-fun
five past one



1時10分
ichi-ji jūppun
ten past one



1時15分
ichi-ji jūgo-fun
quarter past one



1時20分
ichi-ji nijūppun
twenty past one



1時25分
ichi-ji nijūgo-fun
twenty five past one

秒針
byōshin
second hand



1時半
ichi-ji han
one thirty



1時35分
ichi-ji sanjūgo-fun
twenty five to two



1時40分前
ichi-ji yonjūppun
twenty to two



2時15分前
ni-ji jūgo-fun mae
quarter to two



2時10分前
ni-ji jūppun mae
ten to two



2時5分前
ni-ji go-fun mae
five to two



2時
ni-ji
two o'clock

日中と夜 nitchū to yoru • night and day



真夜中 mayonaka | midnight



日の出 hinode | sunrise



夜明け yoake | dawn



朝 asa | morning



日没
nichibotsu
sunset



正午
shōgo
midday



夕暮れ yūgure | dusk



晩 ban | evening



午後 gogo | afternoon

関連用語 kanrenyōgo • vocabulary

早い
hayai
early

早いですね。
hayai desune.
You're early.

時間通りに来てください。
jikan-dōri ni kite kudasai.
Please be on time.

何時に終わりますか。
nanji ni owarimasuka?
What time does it finish?

時間通り
jikan-dōri
on time

遅刻です。
chikoku desu.
You're late.

また後で。
mata ato de.
I'll see you later.

遅くなってきました。
osokunatte kimashita.
It's getting late.

遅い
osoi
late

もうすぐ到着します。
mōsugu tōchaku shimasu.
I'll be there soon.

何時に始まりますか。
nanji ni hajimarimasuka?
What time does it start?

時間は、どのくらいかかりますか。
jikan wa donokurai kakarimasuka?
How long will it last?

カレンダー karendā • calendar

月
tsuki
month

年
toshi
year

一月
ichigatsu
January

2010



曜日
yōbi
day

月曜日
getsuyōbi
Monday

火曜日
kayōbi
Tuesday

水曜日
suiyōbi
Wednesday

木曜日
mokuyōbi
Thursday

金曜日
kin'yōbi
Friday

土曜日
doyōbi
Saturday

日曜日
nichiyōbi
Sunday

週日
shūjitsu
work day

1	2	3	4	5	6	7
8	9	10	11	12	13	14
15	16	17	18	19	20	21

週
shū
week

日にち
hinichi
date

昨日
kinō
yesterday

今日
kyō
today

明日
ashita
tomorrow

週末
shūmatsu
weekend

関連用語 kanrenyōgo • vocabulary

一月
ichigatsu
January

三月
sangatsu
March

五月
gogatsu
May

七月
shichigatsu
July

九月
kugatsu
September

十一月
jūichigatsu
November

二月
nigatsu
February

四月
shigatsu
April

六月
rokugatsu
June

八月
hachigatsu
August

十月
jūgatsu
October

十二月
jūnigatsu
December

年 toshi • years

1900 一九〇〇年 sen kyūhyaku nen • nineteen hundred

1901 一九〇一年 sen kyūhyaku ichi nen • nineteen hundred and one

1910 一九一〇年 sen kyūhyaku jū nen • nineteen ten

2000 二〇〇〇年 nisen nen • two thousand

2001 二〇〇一年 nisen ichi nen • two thousand and one

季節 kisetsu • seasons

春
haru
spring夏
natsu
summer秋
aki
autumn冬
fuyu
winter

関連用語 kanrenyōgo • vocabulary

世紀
seiki
century今週
konshū
this week明後日
asatte
the day after tomorrow今日は何日ですか。
kyō wa nannichi desuka?
What's the date today?十年間
jūnenkan
decade先週
senshū
last week毎週
maishū
weekly2002年2月17日です。
nisen ni nen nigatsu jūshichi nichi desu.
It's February seventeenth, two
thousand and two.千年間
sennenkan
millennium来週
raishū
next week毎月
maitzuki
monthly二週間
nishūkan
fortnight一昨日
ototoi
the day before yesterday毎年
maitoshi
annual

数字 sūji • numbers

0	零 rei • zero	20	二十 nijū • twenty
1	一 ichi • one	21	二十一 nijūichi • twenty-one
2	二 ni • two	22	二十二 nijūni • twenty-two
3	三 san • three	30	三十 sanjū • thirty
4	四 shi/yon • four	40	四十 shijū/yonjū • forty
5	五 go • five	50	五十 gojū • fifty
6	六 roku • six	60	六十 rokjū • sixty
7	七 shichi/nana • seven	70	七十 shichijū/nanajū • seventy
8	八 hachi • eight	80	八十 hachijū • eighty
9	九 ku/kyū • nine	90	九十 kyūjū • ninety
10	十 jū • ten	100	百 hyaku • one hundred
11	十一 jūichi • eleven	110	百十 hyakujū • one hundred and ten
12	十二 jūni • twelve	200	二百 nihyaku • two hundred
13	十三 jūsan • thirteen	300	三百 sambyaku • three hundred
14	十四 jūshi/jūyon • fourteen	400	四百 yonhyaku • four hundred
15	十五 jūgo • fifteen	500	五百 gohyaku • five hundred
16	十六 jūroku • sixteen	600	六百 roppyaku • six hundred
17	十七 jūshichi/jūnana • seventeen	700	七百 nanahyaku • seven hundred
18	十八 jūhachi • eighteen	800	八百 happyaku • eight hundred
19	十九 jūku/jūkyū • nineteen	900	九百 kyūhyaku • nine hundred

1,000	千 sen • one thousand
10,000	一万 ichiman • ten thousand
20,000	二万 niman • twenty thousand
50,000	五万 goman • fifty thousand
55,500	五万五千五百 goman gosen gohyaku • fifty-five thousand five hundred
100,000	十万 jūman • one hundred thousand
1,000,000	百万 hyakuman • one million
1,000,000,000	十億 jūoku • one billion

一番目
ichi banme
first

二番目
ni banme
second

三番目
san banme
third



四番目 yon banme • fourth

五番目 go banme • fifth

六番目 roku banme • sixth

七番目 nana banme • seventh

八番目 hachi banme • eighth

九番目 kyū banme • ninth

十番目 jū banme • tenth

十一番目 jūichi banme •
eleventh

十二番目 jūni banme •
twelfth

十三番目 jūsan banme •
thirteenth

十四番目 jūyon banme •
fourteenth

十五番目 jūgo banme •
fifteenth

十六番目 jūroku banme •
sixteenth

十七番目 jūnana banme •
seventeenth

十八番目 jūhachi banme •
eighteenth

十九番目 jūkyū banme •
nineteenth

二十番目 nijū banme •
twentieth

二十一番目 nijūichi banme •
twenty-first

二十二番目 nijūni banme •
twenty-second

二十三番目 nijūsan banme •
twenty-third

三十番目 sanjū banme •
thirtieth

四十番目 yonjū banme •
fortieth

五十番目 gojū banme •
fiftieth

六十番目 rokjū banme •
sixtieth

七十番目 nanajū banme •
seventieth

八十番目 hachijū banme •
eightieth

九十番目 kyūjū banme •
ninetieth

百番目 hyaku banme •
one hundredth

計量 keiryō • weights and measures

面積 menseki • area

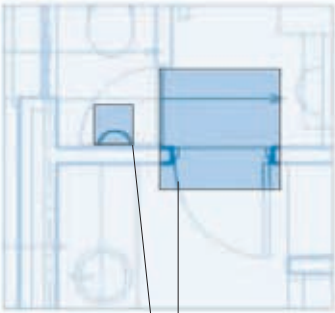

平方フィート
heihō fito
square foot

平方メートル
heihō mētoru
square meter

距離 kyori • distance



キロメートル
kiromētoru
kilometer

マイル
mairu
mile

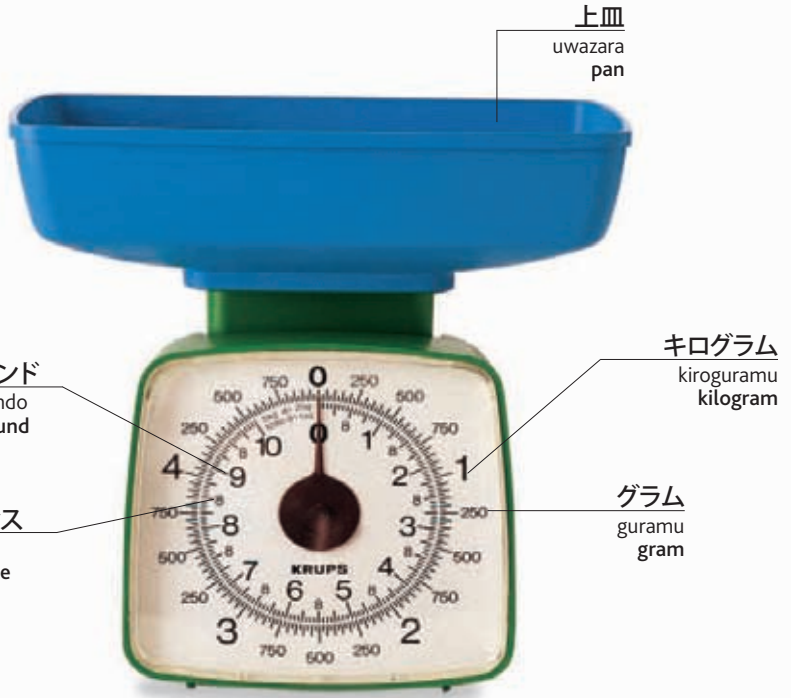

上皿
uwazara
pan

ポンド
pondo
pound

キログラム
kiroguramu
kilogram

オンス
onsu
ounce

グラム
guramu
gram

秤 hakari | scales

関連用語 kanrenyōgo • vocabulary

ヤード
yādo
yard

トン
ton
ton

測る
hakaru
measure (v)

メートル
mētoru
meter

ミリグラム
miriguramu
milligram

量る
hakaru
weigh (v)

長さ nagasa • length

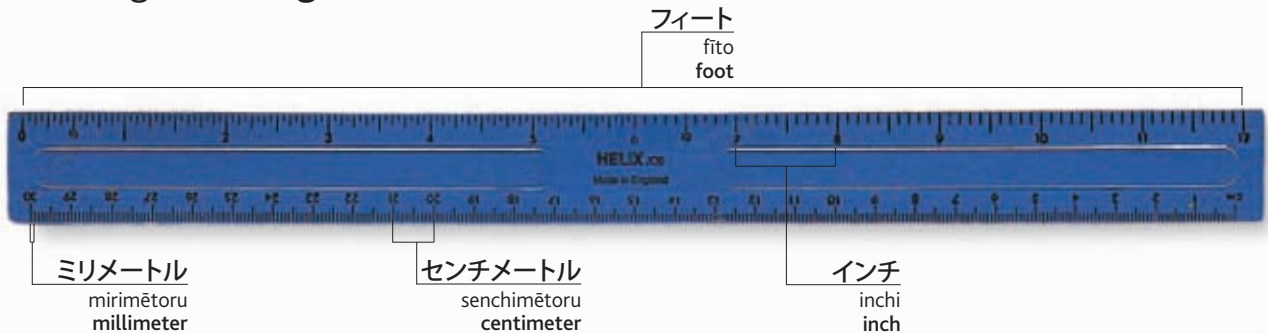

フィート
fito
foot

ミリメートル
mirimētoru
millimeter

センチメートル
senchimētoru
centimeter

インチ
inchi
inch

容量 yōryō • capacity

0.5リットル
rei ten go rittoru
half-liter

パイント
painto
pint

容積
yōseki
volume

ミリリットル
miririttoru
milliliter



計量カップ keiryō kappu | measuring cup



液体計量器 ekitai keiryōki
liquid measure

関連用語
kanrenyōgo •
vocabulary

ガロン
garan
gallon

クォート
kuōto
quart

リットル
ritturu
liter

容器 yōki • container



紙パック
kami pakku
carton



包み
tsutsumi
package



瓶
bin
bottle



袋
fukuro
bag



カップ形容器
kappu-gata yōki | tub



広口瓶 hirokuchi bin | jar



缶
kan
can

缶詰容器 kanzume yōki | tin



霧吹き kirifuki | liquid dispenser



棒
bō
bar



チューブ
chūbu
tube



ロール
rōru
roll



パック
pakku
pack



スプレー缶
supurē kan
spray can

世界地図 sekai chizu • world map

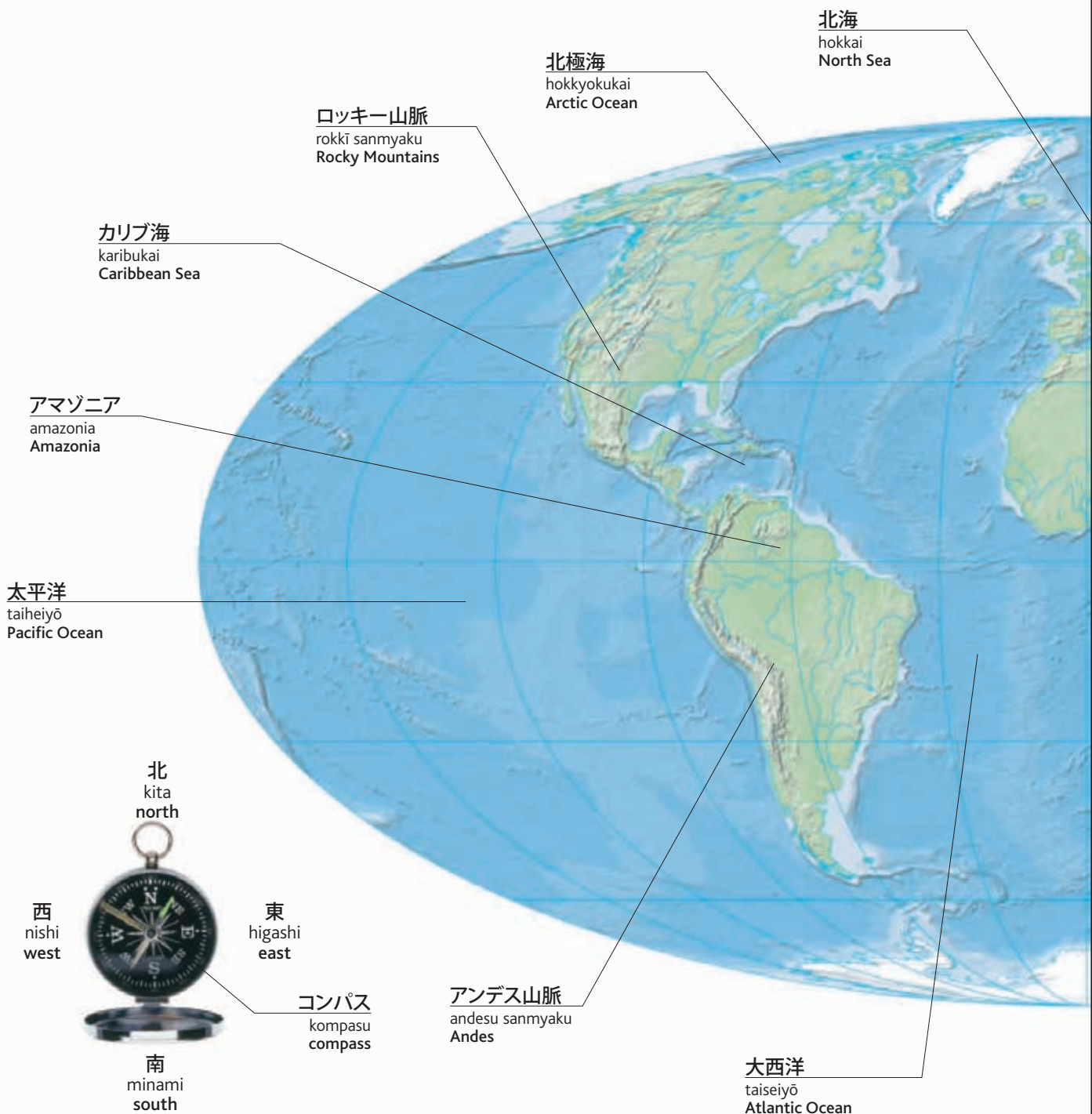

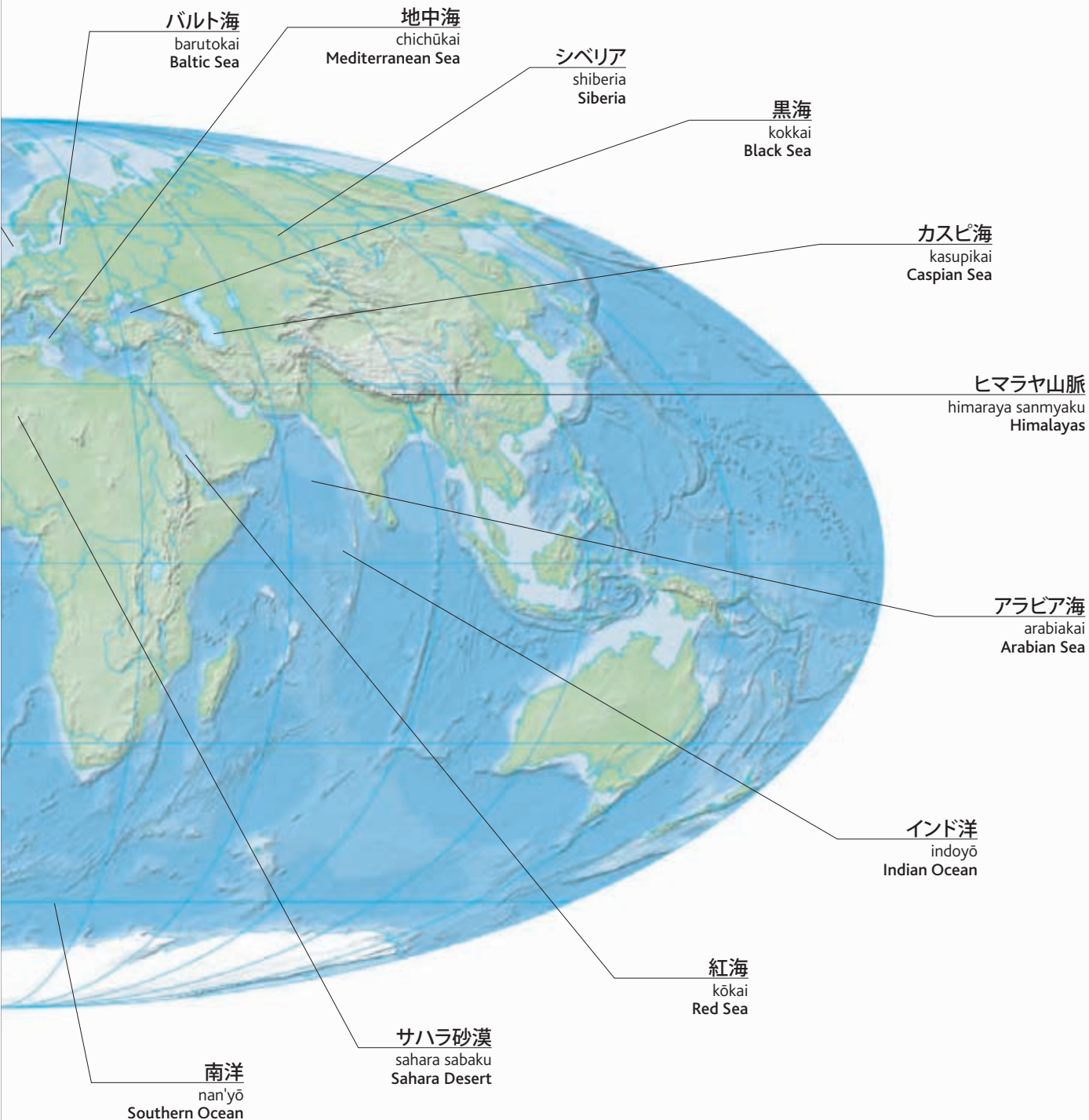

北米と中米 hokubei to chūbei • North and Central America



- 1 アラスカ arasuka • Alaska
- 2 カナダ kanada • Canada
- 3 グリーンランド gurīnrando • Greenland
- 4 アメリカ合衆国 amerika gasshūkoku • United States of America
- 5 メキシコ mekishiko • Mexico
- 6 グアテマラ guatemala • Guatemala
- 7 ベリーズ berīzu • Belize
- 8 エルサルバドル erusarubadoru • El Salvador
- 9 ホンジュラス honjurasu • Honduras
- 10 ニカラグア nikaragua • Nicaragua
- 11 コスタリカ kosutarika • Costa Rica
- 12 パナマ panama • Panama
- 13 キューバ kyūba • Cuba
- 14 バハマ bahama • Bahamas
- 15 ジャマイカ jamaika • Jamaica
- 16 ハイチ haichi • Haiti
- 17 ドミニカ共和国 dominika kyōwakoku • Dominican Republic
- 18 プエルトリコ puerutoriko • Puerto Rico
- 19 バルバドス barubadosu • Barbados
- 20 トリニダード・トバゴ torinidādo tobago • Trinidad and Tobago
- 21 セントクリストファー・ネーヴィス sentokurisutofā nēvisu • St. Kitts and Nevis

- 22 アンティグア・バーブーダ antigua bābūda • Antigua and Barbuda
- 23 ドミニカ dominika • Dominica
- 24 セントルシア sentorushia • St. Lucia
- 24 セントビンセント及びグレナディーン諸島 sentobinsento oyobi gurenadin shotō • St. Vincent and The Grenadines
- 26 グレナダ gurenada • Grenada

南米 nambei • South America



- 1 ベネズエラ benezuera • Venezuela
- 2 コロンビア korombia • Colombia
- 3 エクアドル ekuadoru • Ecuador
- 4 ペルー perū • Peru
- 5 ガラパゴス諸島 garapagosu shotō • Galapagos Islands
- 6 ギアナ giana • Guyana
- 7 スリナム surinamu • Suriname
- 8 仏領ギアナ futsuryō giana • French Guiana
- 9 ブラジル burajiru • Brazil
- 10 ボリビア boribia • Bolivia
- 11 チリ chiri • Chile
- 12 アルゼンチン aruzenchin • Argentina
- 13 パラグアイ paraguai • Paraguay
- 14 ウルグアイ uruguai • Uruguay
- 15 フォークランド諸島 fōkurando shotō • Falkland Islands

関連用語 kanrenyōgo • vocabulary

国 kuni country	地方 chihō province	地帯 chitai zone
国家 kokka nation	領土 ryōdo territory	地区 chiku district
大陸 tairiku continent	植民地 shokuminchi colony	地域 chi'iki region
州 shū state	公国 kōkoku principality	首都 shuto capital

ヨーロッパ yōroppa • Europe

- | | | |
|--|---|--|
| 1 アイルランド airurando • Ireland | 30 バチカン市国 bachikan shikoku • Vatican City | 41 セルビア serubia • Serbia |
| 2 英国 eikoku • United Kingdom | 31 シチリア shichiria • Sicily | 42 ボスニア・ヘルツェゴビナ bosunia herutsegobina • Bosnia and Herzegovina |
| 3 ポルトガル porutogaru • Portugal | 32 マルタ maruta • Malta | 43 アルバニア arubania • Albania |
| 4 スペイン supein • Spain | 33 スロベニア surobenia • Slovenia | 44 マケドニア makedonia • Macedonia |
| 5 バレアレス諸島 barearesu shotō • Balearic Islands | 34 クロアチア kuroachia • Croatia | 45 ブルガリア burugaria • Bulgaria |
| 6 アンドラ andora • Andorra | 35 ハンガリー hangarī • Hungary | 46 ギリシャ girisha • Greece |
| 7 フランス furansu • France | 36 スロバキア surobakia • Slovakia | 47 コソボ kosobo • Kosovo |
| 8 ベルギー berugī • Belgium | 37 ウクライナ ukuraina • Ukraine | 48 モンテネグロ monteneguro • Montenegro |
| 9 オランダ oranda • Netherlands | 38 ベラルーシ berarūshi • Belarus | |
| 10 ルクセンブルク rukusemburuku • Luxembourg | 39 モルドバ morudoba • Moldova | |
| 11 ドイツ doitsu • Germany | 40 ルーマニア rūmania • Romania | |
| 12 デンマーク denmāku • Denmark | | |
| 13 ノルウェー noruwē • Norway | | |
| 14 スウェーデン suwēden • Sweden | | |
| 15 フィンランド finrando • Finland | | |
| 16 エストニア esutonia • Estonia | | |
| 17 ラトビア ratobia • Latvia | | |
| 18 リトアニア ritoania • Lithuania | | |
| 19 カリーニングラード karīningurādo • Kaliningrad | | |
| 20 ポーランド pōrando • Poland | | |
| 21 チェコ共和国 cheko kyōwakoku • Czech Republic | | |
| 22 オーストリア ōsutoria • Austria | | |
| 23 リヒテンシュタイン rihitenshutain • Liechtenstein | | |
| 24 スイス suisu • Switzerland | | |
| 25 イタリア itaria • Italy | | |
| 26 モナコ monako • Monaco | | |
| 27 コルシカ korushika • Corsica | | |
| 28 サルディニア sarudinia • Sardinia | | |
| 29 サンマリノ sanmarino • San Marino | | |



アフリカ afurika • Africa

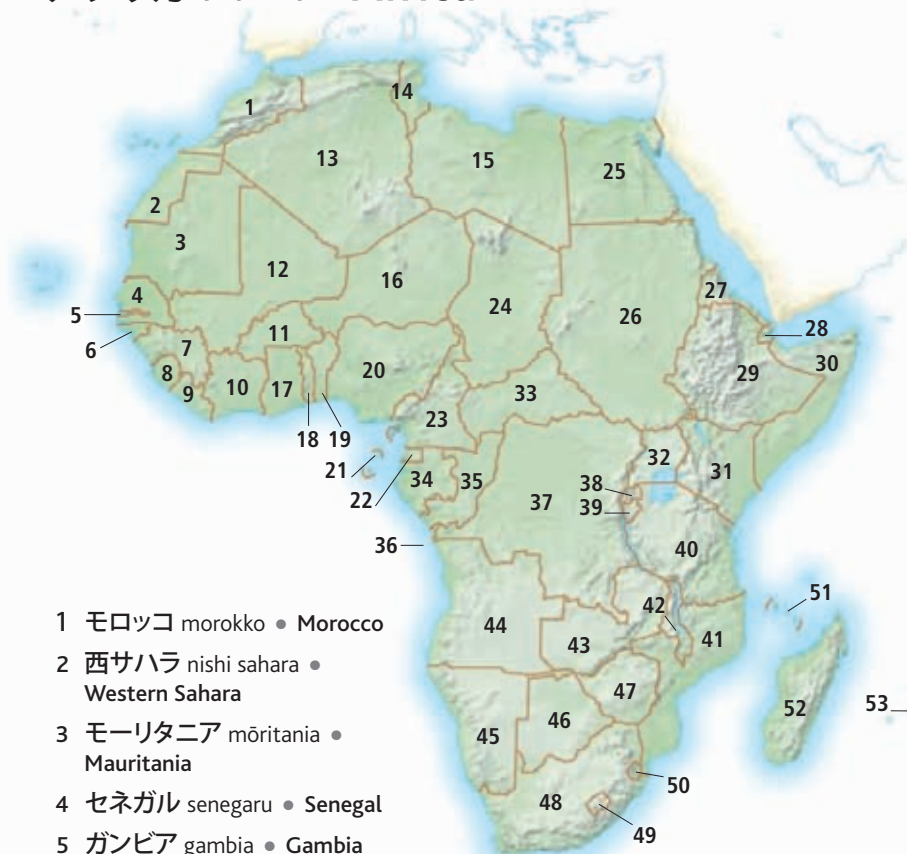

- 1 モロッコ morokko • Morocco
- 2 西サハラ nishi sahara • Western Sahara
- 3 モーリタニア mōritania • Mauritania
- 4 セネガル senegaruru • Senegal
- 5 ガンビア gambia • Gambia
- 6 ギニアビサウ giniabisau • Guinea-Bissau
- 7 ギニア ginia • Guinea
- 8 シエラレオネ shierareone • Sierra Leone
- 9 リベリア riberia • Liberia
- 10 コートジボワール kōtojobowāru • Ivory Coast
- 11 ブルキナファソ burukinafaso • Burkina Faso
- 12 マリ mari • Mali
- 13 アルジェリア arujeria • Algeria
- 14 チュニジア chunijia • Tunisia
- 15 リビア ribia • Libya
- 16 ニジェール nijēru • Niger
- 17 ガーナ gāna • Ghana
- 18 トーゴ tōgo • Togo

- 19 ベニン benin • Benin
- 20 ナイジェリア naijeria • Nigeria
- 21 サントメ・プリンシペ santome purinshipe • Sao Tome and Principe
- 22 赤道ギニア sekidō ginia • Equatorial Guinea
- 23 カメルーン kamerūn • Cameroon
- 24 チャド chado • Chad
- 25 エジプト ejiputo • Egypt
- 26 スーダン sūdān • Sudan
- 27 エリトリア eritoria • Eritrea
- 28 ジブチ jipuchi • Djibouti
- 29 エチオピア echiopia • Ethiopia
- 30 ソマリア somaria • Somalia

- 31 ケニア kenia • Kenya
- 32 ウガンダ uganda • Uganda
- 33 中央アフリカ共和国 chūō afurika kyōwakoku • Central African Republic
- 34 ガボン gabon • Gabon
- 35 コンゴ kongo • Congo
- 36 カビンダ kabinda • Cabinda
- 37 コンゴ民主共和国 kongo minshu kyōwakoku • Democratic Republic of the Congo
- 38 ルワンダ ruwanda • Rwanda
- 39 ブルンジ burunji • Burundi
- 40 モザンビーク mizambiku • Mozambique
- 41 タンザニア tanzania • Tanzania
- 42 マラウィ marawi • Malawi
- 43 ザンビア zambia • Zambia
- 44 アンゴラ angora • Angola
- 45 ナミビア namibia • Namibia
- 46 ボツワナ botsuwana • Botswana
- 47 ジンバブエ jimbabue • Zimbabwe
- 48 南アフリカ minami afurika • South Africa
- 49 レソト resoto • Lesotho
- 50 スワジランド suwajirando • Swaziland
- 51 コモロ komoro • Comoros
- 52 マダガスカル madagasukaru • Madagascar
- 53 モーリシャス mōrishasu • Mauritius

アジア ajia • Asia

- 1 トルコ toruko • Turkey
- 2 キプロス kipurosu • Cyprus
- 3 ロシア連邦 roshia rempō • Russian Federation
- 4 グルジア gurujia • Georgia
- 5 アルメニア arumenia • Armenia
- 6 アゼルバイジャン azerubaijan • Azerbaijan
- 7 イラン iran • Iran
- 8 イラク iraku • Iraq
- 9 シリア shiria • Syria
- 10 レバノン rebanon • Lebanon
- 11 イスラエル isuraeru • Israel
- 12 ヨルダン yorudan • Jordan
- 13 サウジアラビア saujiarabia • Saudi Arabia
- 14 クウェート kuwēto • Kuwait
- 15 バーレーン bārēn • Bahrain
- 16 カタール katāru • Qatar
- 17 アラブ首長国連邦 arabu shuchō-koku rempō • United Arab Emirates
- 18 オマーン omān • Oman
- 19 イエメン iemen • Yemen
- 20 カザフスタン kazafusutan • Kazakhstan
- 21 ウズベキスタン uzubekisutan • Uzbekistan
- 22 トルクメニスタン torukumenisutan • Turkmenistan
- 23 アフガニスタン afuganisutan • Afghanistan
- 24 タジキスタン tajikisutan • Tajikistan
- 25 キルギスタン kirigisutan • Kyrgyzstan
- 26 パキスタン pakisutan • Pakistan
- 27 インド indo • India
- 28 モルディブ morudibu • Maldives
- 29 スリランカ suriranka • Sri Lanka
- 30 中国 chūgoku • China
- 31 モンゴル mongoru • Mongolia
- 32 北朝鮮 kita chōsen • North Korea
- 33 韓国 kankoku • South Korea
- 34 日本 nihon • Japan
- 35 ネパール nepāru • Nepal



- 36 ブータン būtan • Bhutan
- 37 バングラデシュ banguradeshu • Bangladesh
- 38 ビルマ(ミャンマー) biruma (myanmā) • Myanmar
- 39 タイ tai • Thailand
- 40 ラオス raosu • Laos
- 41 ベトナム betonamu • Viet Nam
- 42 カンボジア kambojia • Cambodia

オーストラレーシア
ōsutorarēshia • Australasia

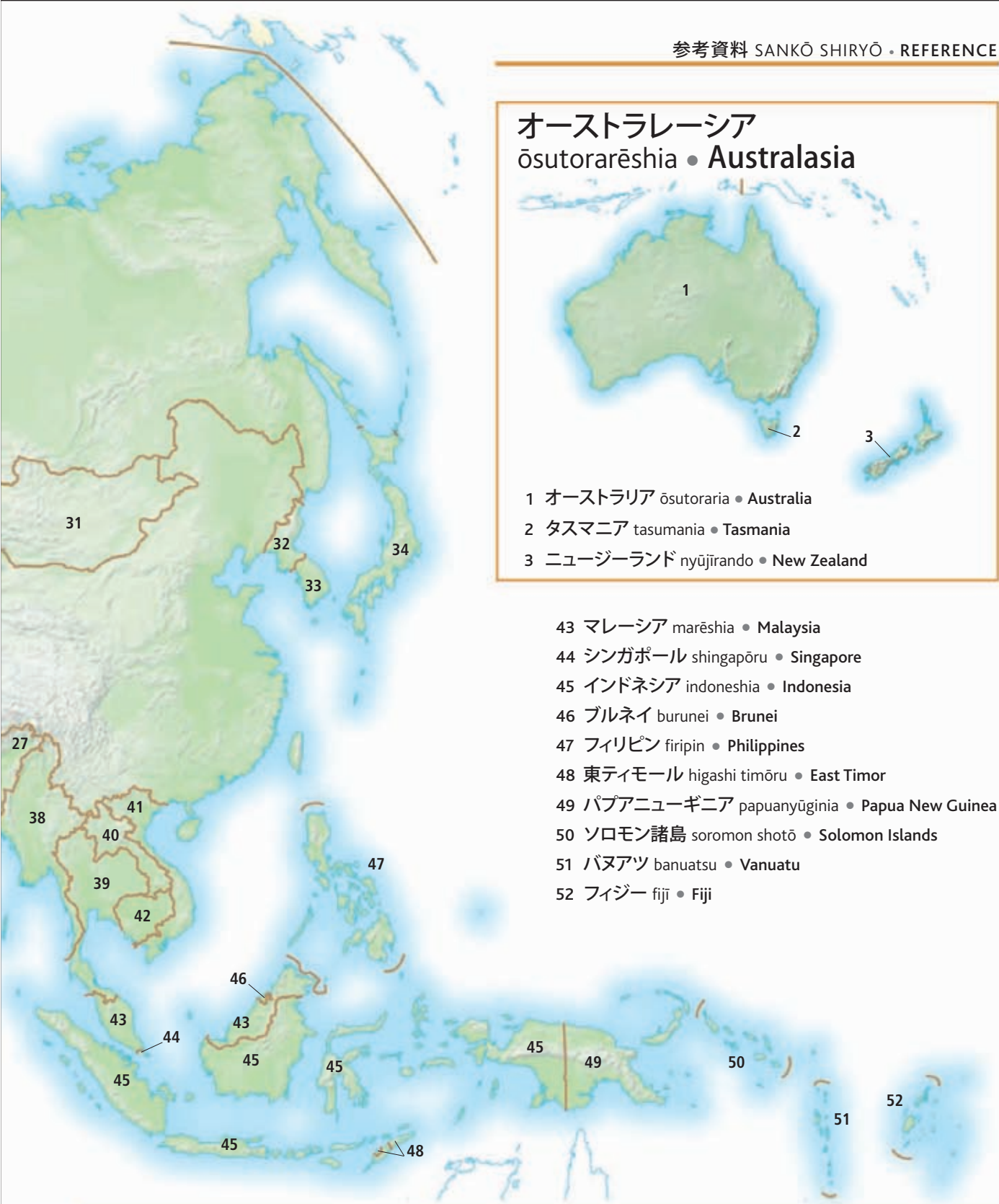

- 43 マレーシア marēshia • Malaysia
- 44 シンガポール shingapōru • Singapore
- 45 インドネシア indoneshia • Indonesia
- 46 ブルネイ burunei • Brunei
- 47 フィリピン firipin • Philippines
- 48 東ティモール higashi timōru • East Timor
- 49 パプアニューギニア papuanyūginia • Papua New Guinea
- 50 ソロモン諸島 soromon shotō • Solomon Islands
- 51 バヌアツ banuatsu • Vanuatu
- 52 フィジー fiji • Fiji

不変化詞と反義語 fuhenkashi to hangigo • particles and antonyms

...へ
... e
to ...

...の上方
... no jōhō
over ...

...の前
... no mae
in front of ...

...の上へ
... no ue e
onto ...

中
naka
in

真上
maue
above

内側
uchigawa
inside

上へ
ue e
up

...で
... de
at ...

...を通過して
... o tōtte
through ...

...の上
... no ue
on top of ...

...の間
... no aida
between ...

近い
chikai
near

ここ
koko
here

...から
... kara
from ...

...の下方
... no kahō
under ...

...の後ろ
... no ushiro
behind ...

...の中へ
... no naka e
into ...

外
soto
out

真下
mashita
below

外側
sotogawa
outside

下へ
shita e
down

...の向こう
... no mukō
beyond ...

...を回って
... o mawatte
around ...

...の側
... no soba
beside ...

...の向かい側
... no mukaigawa
opposite ...

遠い
tōi
far

あそこ
asoko
there

...から離れて
... kara hanarete
away from...

...に沿って
... ni sotto
along ...

...と一緒に
... to issho ni
with ...

...以前
... izen
before ...

...までに
... made ni
by ...

早い
hayai
early

今
ima
now

いつも
itsumo
always

頻繁に
himpan ni
often

昨日
kinō
yesterday

最初
saisho
first

あらゆる
arayuru
every

およそ
oyoso
about

少し
sukoshi
a little

...に向かって
... ni mukatte
toward ...

...を横切って
... o yokogitte
across ...

...なしで
... nashi de
without ...

...以後
... igo
after ...

...まで
... made
until ...

遅い
osoi
late

後ほど
nochihodo
later

決して...ない
kesshite ... nai
never

稀に
mare ni
rarely

明日
ashita
tomorrow

最後
saigo
last

いくつかの
ikutsuka no
some

丁度
chōdo
exactly

沢山
takusan
a lot

大きい ōkī large	小さい chīsai small	熱い atsui hot	冷たい tsumetai cold
幅の広い haba no hiroi wide	幅の狭い haba no semai narrow	開いた hiraita open	閉まった shimatta closed
背の高い se no takai tall	背の低い se no hikui short	満ちた michita full	空の kara no empty
高い takai high	低い hikui low	新しい atarashī new	古い furui old
厚い atsui thick	薄い usui thin	明るい akarui bright	暗い kurai dark
軽い karui light	重い omoi heavy	簡単な kantan na easy	難しい muzukashī difficult
硬い katai hard	柔らかい yawarakai soft	空き aki free	使用中 shiyō-chū occupied
湿った shimetta wet	乾いた kawaita dry	強い tsuyoi strong	弱い yowai weak
良い yoi good	悪い warui bad	太い futoi fat	細い hosoi thin
速い hayai fast	ゆっくりした yukkurishita slow	若い wakai young	老いた oita old
正しい tadashī correct	誤った ayamatta wrong	より良い yori yoi better	もっと悪い motto warui worse
きれいな kirei na clean	汚い kitanai dirty	黒 kuro black	白 shiro white
美しい utsukushī beautiful	醜い minikui ugly	面白い omoshiroi interesting	つまらない tsumaranai boring
高価な kōka na expensive	安い yasui cheap	病気の byōki no sick	健康な kenkō na well
静かな shizuka na quiet	うるさい urusai noisy	始め hajime beginning	終わり owari end

便利な表現 benri na hyōgen • useful phrases

基本的表現
kihonteki hyōgen
• essential phrases

はい
hai
Yes

いいえ
īe
No

多分
tabun
Maybe

どうぞ
dōzo
Please

ありがとう
arigatō
Thank you

どういたしまして
dō itashimashite
You're welcome

すみません
sumimasen
Excuse me

ごめんなさい
gomen nasai
I'm sorry

...しないでください
... shinaide kudasai
Don't ...

オーケー
ōkē
OK

それで結構です
sorede kekkō desu
That's fine

そうです
sōdesu
That's correct

違います
chigaimasu
That's wrong

挨拶 aisatsu •
greetings

もしもし
moshimoshi
Hello (*on telephone*)

さようなら
sayōnara
Goodbye

おはようございます
ohayō gozaimasu
Good morning

こんにちは
konnichiwa
Good afternoon

こんばんは
kombanwa
Good evening

おやすみなさい
oyasuminasai
Good night

お元気ですか
o-genki desuka
How are you?

私は...です
watashi wa ... desu
My name is...

お名前は何ですか
o-namae wa nan desuka?
What is your name?

彼/彼女のお名前は
kare/kanojo no o-namae wa?
What is his/her name?

...をご紹介します
... o go-shōkai shimasu
May I introduce...

こちらは...です
kochira wa ... desu
This is...

初めまして
hajimemashite
Pleased to meet you

また後で
mata ato de
See you later

標識 hyōshiki • signs

観光案内所
kankō annai-jo
Tourist information

入口
iriguchi
Entrance

出口
deguchi
Exit

非常口
hijōguchi
Emergency exit

押す
osu
Push

危険
kiken
Danger

禁煙
kin'en
No smoking

故障中
koshōchū
Out of order

開館時間
kaikan jikan
Opening times

入場無料
nyūjō muryō
Free admission

全日営業
zennichi eigyō
Open all day

割引料金
waribiki ryōkin
Reduced price

特売
tokubai
Sale

ノックしてください
nokku shite kudasai
Knock before entering

芝生立ち入り禁止
shibafu tachi'iri kinshi
Keep off the grass

援助 enjo • help

助けてください
tasukete kudasai
Please help me

分かりません
wakarimasen
I don't understand

知りません
shirimasen
I don't know

英語/日本語を話せますか
eigo/nihongo o
hanasemasuka?
Do you speak English/
Japanese?

英語を話せませ
eigo hanasemasu
I speak English

スペイン語を話せませ
suepingo o hanasemasu
I speak Spanish

もっとゆっくり言ってくだ
さい
motto yukkuri itte kudasai
Please speak more slowly

書いてください
kaite kudasai
Please write it down for me

...をなくしました
... o nakushimashita
I have lost...

道案内 michi annai •
directions

道に迷いました
michi ni mayoimashita
I am lost

...はどこですか
... wa doko desuka?
Where is the...?

最寄りの...はどこですか
moyori no ... wa doko
desuka?
Where is the nearest...?

お手洗いはどこですか
o-tearai wa doko desuka?
Where are the toilets?

右です
migi desu
To the right

左です
hidari desu
To the left

まっすぐです
massugu desu
Straight ahead

...は、どのくらい離れてい
ますか
... wa donokurai hanarete
imasuka
How far is...?

...への行き方を教えてく
ださい
... e no ikikata o oshiete
kudasai
How do I get to...?

道路標識 dōro hyōshiki
• road signs

注意
chūi
Caution

進入禁止
shinnyū kinshi
No entry

スピード落せ
supīdo otose
Slow down

迂回路
ukairo
Diversion

右側通行
migigawa tsūkō
Keep to the right

高速道路
kōsokudōro
Motorway

駐車禁止
chūsha kinshi
No parking

通行禁止
tsūkō kinshi
No through road

道路工事中
dōro kōji-chū
Roadworks

一方通行
ippōtsūkō
One-way street

譲れ
yuzure
Give way

止まれ
tomare
Stop

屈折あり
kussetsu ari
Dangerous bend

宿泊 shukuhaku •
accomodation

予約してあります
yoyaku shite arimasu
I have a reservation

朝食は何時ですか
chōshoku wa nanji
desuka
What time is breakfast?

食堂はどこですか
shokudō wa doko desuka?
Where is the dining room?

私の部屋は...号室です
watashi no heya wa
...-gōshitsu desu
My room number is...

...時に戻ります
... ji ni modorimasu
I'll be back at...o'clock

飲食 inshoku •
eating and drinking

乾杯!
kampai
Cheers!

美味しい/不味いです
oishi/mazui desu
It's delicious/awful

お酒は飲みません
o-sake wa nomemasen
I don't drink

煙草は吸いません
tabako wa suimasen
I don't smoke

肉は食べません
niku wa tabemasen
I don't eat meat

もう結構です
mō kekkō desu
No more for me, thank you

もう少し、いただけますか
mō sukoshi itadakemasuka?
May I have some more?

会計をお願いします
kaiei o onegaishimasu
Please give us the bill

領収書をください
ryōshūsho o kudasai
Please give us a receipt

禁煙席
kin'en seki
No-smoking area

健康 kenkō •
health

体調が優れません
taichō ga suguremasen
I don't feel well

気分が悪いです
kibun ga warui desu
I feel sick

最寄りの医者電話番号
は何ですか
moyori no isha no
denwabangō wa nan desuka?
What is the telephone
number of the nearest
doctor?

ここが痛いです
koko ga itai desu
It hurts here

熱があります
netsu ga arimasu
I have a temperature

妊娠...ヶ月です
ninshin ...-kagetsu desu
I'm...months pregnant

...の処方箋をください
... no shohōsen o kudasai
I need a prescription for...

普段は...を飲みます
fudan wa ... o nomimasu
I normally take ...

...にアレルギーがあります
... ni arerugi ga arimasu
I'm allergic to ...

大丈夫ですか
daijōbu desuka?
Will he/she be all right?

日本語索引 | nihongo sakuin • Japanese index

A

abaraniku 119
 abokado 128
 abumi 242
 abura 142
 abura enogu 274
 abura hada 41
 abura shitsu 39
 abura-zuke 143
 aburami 119
 abuzairen 248
 āchi 85, 301
 āchi-gata yane 300
 adobantēji 230
 aen 289
 aen mekki 79
 afuganisutan 318
 afurika 317
 afutāsankea 108
 afutāshēbu 73
 ageru 67
 ageta 159
 ago 14
 agurifurūtsu 126
 ahiru no tamago 137
 ai yū dī 21
 ai'iro 274
 aian 233
 aiburow- burashi 40
 aiburow-penshiru 10
 aikappu 269
 aikidō 236
 aikon 177
 airainā 40
 airon 76
 airon o kakeru 76
 airondai 76
 airurando 316
 aisatsu 322
 aishadō 40
 aishingu 141
 aisu baketsu 150
 aisu hokkē 224
 aisu kōhī 148
 aisu kuraimingu 147
 aisu sukēto 247
 aisu tī 149
 aisu hokkē senshu 224
 aisu hokkē-yō rinku 224
 aisu kurūrimu 137, 149
 aisu kurūrimu sukūpu 68
 aite 236
 ajia 318
 aka 274
 aka (wain) 145
 aka chikori 123
 aka rentiru 131
 aka tōgarashi 124
 akachairo 39
 akachan 30
 akachan-yō taijūkei 53
 akage 39

akame 271
 akami niku 118
 akarui 321
 akashia 110
 aki 31, 307, 321
 akiresuken 16
 akiru 25
 ākitorēbu 301
 akuamarin 288
 akubi suru 25
 akuriru enogu 274
 akuseru 200
 akusesari 36
 akusuru 205
 ama 184
 amadoi 58
 amagu 245, 267
 amai 124, 127, 155
 amakawa 15
 amazonia 312
 amba 235
 ame 287
 ame-gachi na 286
 amefuto shūzu 220
 amejisuto 288
 amerika gasshūkoku 314
 amerikan futtobōru 220
 ameya 113
 ami 217
 amiagegutsu 37
 amibari 277
 amidana 209
 amimono 277
 amiuchi suru 245
 āmondo 129, 151
 āmondo oiru 134
 ampaia 225
 ampea 60
 ampu 268
 āmu kāru 251
 āmu resuto 200
 āmubando 238
 āmuchoe 63
 ana 244
 ana o akeru 79
 ana'ake panchi 173
 ana'aki supūn 68
 andā pā 233
 andesu sanmyaku 312
 andora 316
 angora 317
 anime 178
 anime eiga 255
 ankō 120
 ankōru 255
 annai 261
 annai zu 261
 annai-ban 213
 annai-gakari 255
 anorakku 31, 33
 anshitsu 271
 anshō bangō 96

antigua bābūda 314
 anzempin 47
 anzen gōguru 167
 anzen saku 246
 anzen yōgu 240
 anzen yōhin 75
 anzu 126
 ao 274
 aoi 129
 apurikēshon 176
 arabiakai 313
 arabiki mugī 130
 arabu shuchō-koku rempō 318
 arakaruto 152
 araseitō 110
 arashi 287
 arasuka 314
 arau 38, 77
 arayuru 320
 arenjimento 111
 arerugi 44
 ari 295
 arigatō 322
 arigētā 293
 arīna 243
 aromaterapī 55
 āru deko 301
 āru nūbō 301
 arubamu 271
 arubania 316
 arurarufa 184
 arujeria 317
 arukōru inryō 145
 arumenia 318
 aruminiumu 289
 arupen sukī 247
 aruzenchin 315
 asa 305
 asari 121
 asase 239
 asatsuki 133
 asatte 307
 ashi 12, 13, 15, 64, 119
 ashi no kō 15
 ashi no kō no uchigawa 15
 ashi no koyubi 15
 ashi no oyayubi 15
 ashi no tsume 15
 ashiba 186
 ashika 290
 ashikubi 13, 15
 ashisutanto 24
 ashita 306, 320
 ashiura 15
 ashiyubi 15
 asobi 75
 asobiba 263
 asobu 273
 asoko 320
 atakkingu zōn 224
 atama 12, 19, 80
 atarashī 130, 321

atataakai 286
 atataakai nomimono 144
 atatamenaosu 154
 ātichōku 124
 atopisei hifuen 44
 atoriumu 104
 atsu-giri 121
 atsugami 275
 atsui 286, 321
 atsuryoku barubu 61
 auto 225, 228
 auto obu baunzu 226
 autorigā 187
 awa 148
 awadateki 68
 awadateru 67
 awaseru 179
 ayamatta 321
 ayame 110
 ayuruvēda 55
 aza 46
 azami 297
 azarashi 290
 aze 183
 azerbaijan 318
 azuki 131

B

bā 150, 235, 250
 bā sutsūru 150
 baba bajutsu 243
 bābekyū 267
 bāberu 251
 baburu basu 73
 bachikan shikoku 316
 badominton 231
 bāgā miru 154
 bagetto 138
 baggu 37
 bahama 314
 baiauron 247
 baiku uea 205
 baiorin 256
 baishin'in 180
 baishin'in seki 180
 baito 176
 baizā 205
 bajiriko 133
 bajji 94
 baketsu 77, 82, 265
 bakku 223
 bakku mirā 198
 bakku suru 195
 bakkubōdo 226
 bakkugyamon 272
 bakkuhando 231
 bakkuru 36
 bakkusuingu 233
 bākōdo 106
 bākōdo yomitori sōchi 106
 bakuga inryō 144
 bakugekiki 211

bampā 198
 ban 305
 banana 128
 bandoēdo 47
 banebakari 166
 bangō annai 99
 bangumi 269
 bangumi seisaku 178
 banguradeshu 318
 banira 132
 banji jampu 248
 banjō gēmu 272
 bankā 232
 bansōkō 47
 banuatsu 319
 banzu 155
 bappu 139
 bara 89, 110
 barē 255
 barearesu shotō 316
 barēbōru 227
 barokku 301
 baroku 242
 barubadosu 314
 barubu 207
 barukoni seki 254
 barumitsubā 26
 barusamiko su 135
 barutokai 313
 basha rēsu 243
 bashsi 50
 basu 196
 basu kurarinetto 257
 basu machiai-jo 197
 basu matto 72
 basu no untenshu 190
 basu tāminaru 197
 basu taoru 73
 basu-tei 197
 basuketto 95, 226, 263
 basukettobōru 226
 basukettobōru senshu 226
 basuku 35
 basurōbu 73
 basutei 299
 batā 137, 156
 batafurai 239
 batāmīruku 137
 batānatto sukuwasshu 125
 bāten 150, 191
 baton 235
 battā 228
 batterī 202
 batto 225, 228
 battsuman 225
 baundari 225
 baundo suru 227
 bayonetto-shiki 60
 bebi basu 74
 bebi gēto 75
 bebi kea 74
 bebi monitā 75

- bebī rūmu 104
 bebī suringu 75
 bebī yōhin 107
 bebī-yō magu kappu 75
 bebībēdo 74
 bebīgurō 30
 bebīkā 75
 bebīsākuru 75
 beddo 70, 71
 beddo bampā 74
 beddo sukāto 71
 beddokabā 70
 beddomēkingu suru 71
 beddosaido rampu 70
 beddosaido tēburu 70
 bēguru 139
 beji bāgā 155
 bēkingu torei 69
 bēkon 118, 157
 benchi 250, 262
 beneshan buraindo 63
 benezuera 315
 bengoshi 180, 190
 benin 317
 benki 61, 72
 bentō 154
 benza 61, 72
 beranda 59
 berarūshi 316
 berīzu 314
 bero 37
 beru 197
 bēru 35
 berugi 316
 beruto 32, 36
 beruto kombea 106
 bēshisuto 258
 bēsu 99
 bēsu gitā 258
 bēsuirain 230
 besuto 33, 35
 betonamu 318
 biburafon 257
 bīchi baggu 264
 bīchi bōru 265
 bīchi parasoru 264
 bīchi taoru 265
 bide 72
 bideo denwa 99
 bideo rekōdā 269
 bideo tēpu 269
 bihin 38
 bijimesu'ūman 175
 bijinesu 175
 bijinesu kurasu 211
 bijinesu pātonā 24
 bijinesu ranchi 175
 bijinesuman 175
 bijutsu 162
 bijutsu daigaku 169
 bijutsu to kōgei 274
 bijutsukan 261
 bijutsushi 169
 bīkā 167
 bikini 264
 bikotsu 17
 biku 245
 bin 134, 135, 311
 biniru tai 89
 bankan hada 41
 binmei 212
 binzume furūtsu 135
 binzume shokuhin 134
 biora 256
 bīru 145, 151
 biruma (myanmā) 318
 bishin 283
 bishō 25
 bishoppu 272
 bisuketto 141
 bitā 145
 bitamin-zai 108
 bito 259
 bitōrūto 125
 biyō 40
 biyōin 115
 biyoku 210
 biyōshi 188
 biza 213
 bō 311
 bō-tsuki kyandī 113
 bōrā 225
 bobin 276
 bobu 39
 bobusurē 247
 bodi rōshon 73
 bōdo 241
 bōfū fensu 265
 bōfuzai 83
 bōgyo 220
 bōhan beru 58
 bōhatei 217
 bōifurendo 24
 boirā 61
 bōken 255
 bokuksu seki 254
 bōkō 20, 94
 bokusasaizu 251
 bokusāshōtsu 33
 bokushingu 236
 bokusō-chi 182
 bokuyō nōjō 183
 bongo 257
 bonnetto 198
 borādō 298
 borē 231
 boribia 315
 bōringu 249
 bōru 65, 75, 112, 220, 224,
 226, 228, 230, 249
 bōrubōi 231
 bōsai ono 95
 bōshi 36
 boshikyū 15
 bosunia herutsegobina 316
 bōtakatobi 234
 botan 32, 111
 botanhōru 32
 botchangari 39
 bōto 214
 botoru 61
 botsuwana 317
 budō 127, 237
 budō abura 134
 budō no ki 183
 budōen 183
 bui 217
 buinekku 33
 būke 35, 111
 būkegaruni 132
 bumben 52
 bumbetsu yunitto 61
 bumbo 165
 bumbōgu 105
 būmu 240
 būmumaiku 179
 buna 296
 bundoki 165
 bungaku 162, 169
 bunki-tai 194
 bunrui-dana 100
 bunryō 151
 bunshi 165, 297
 bunsū 165
 bunzen bānā 166
 burajā 35
 burajiru 315
 burajirunattsu 129
 burakku hōru 280
 burakku kōhi 148
 burakku pudingu 157
 burakkuberi 127
 burakkukaranto 127
 burandē 145
 buranko 263
 burashi 40, 77
 burashi o kakeru 38
 burausu 34
 burauza 177
 bureddo naifu 68
 burēdo 66
 burēki 200, 204, 206
 burēki furūdo tanku 202
 burēki o kakeru 207
 burēki paddo 207
 burēki pedaru 205
 burēki rebā 207
 buresuretto 36
 burezā 33
 burī chizu 142
 burīfu 33
 burīfukēsu 37
 burījji 258, 273
 buriosshu 157
 burō suru 38
 burōchi 36
 burōkā 97
 burokkori 123
 burokku suru 227
 burondo 39
 burū chizu 136
 burūberī 127
 burugaria 316
 burukinafaso 317
 burunei 319
 burunetto 39
 burunji 317
 burūsu 259
 būsutā 281
 buta 185
 butagoya 185
 butai 254
 būtan 318
 butaniku 118
 būti 30
 butikku 115
 butsuri 162
 butsurigaku 169
 buyō gakuin 169
 byō 304
 byōin 48
 byōki 44
 byōki no 321
 byōri-ka 49
 byōshin 304
 byōshitsu 48
 byuffe 152
 C
 cha 184
 chado 317
 chairu 274
 chairudo shito 198, 207
 chakka-zai 266
 chakku 78
 chako 276
 chakuriku sōchi 210
 chakuriku suru 211
 chan 23
 channeru 178
 channeru o kaeru 269
 chatsune 135
 chawan 64
 chedā chizu 142
 chekkā 272
 chekkuauto 106
 chekkuin suru 212
 cheko kyōwakoku 316
 chekuin desuku 213
 chēn 36, 206
 chero 256
 chesu 272
 chesuban 272
 chesuto puresu 251
 chi'iki 315
 chiaridā 220
 chibusa 12
 chichi 22
 chichi o shiboru 183
 chichūkai 313
 chihō 315
 chijin 24
 chikai 320
 chikaku 282
 chikashitsu 58
 chikatetsu 208
 chikatetsu rosenzu 209
 chiketto uriba 255
 chikin bāgā 155
 chikin nagetto 155
 chikori 122
 chiku 315
 chikubi 12, 75
 chikusha 185
 chikyū 280, 282
 chīmu 220, 229
 chindei 85
 chingensai 123
 chinjutsu-sho 180
 chinsei-zai 109
 chippu 152
 chippubōdo 79
 chippushotto o utsu 233
 chiri 162
 chiritori 77
 chisai 321
 chisei 284
 chissoku suru 47
 chitai 283, 315
 chitsu 20
 chizu 195, 261
 chizu 136, 156
 chō 295
 chōba 235
 chōdo 320
 chōge 300
 chōha 179
 chōhen eiga 269
 chōhōkei 164
 chōji 125
 chōka hikidashi 96
 chōka nimotsu 212
 chokin 96
 chokkei 164
 chokobā 113
 chōkoku 275
 chōkokuka 191
 chōkokutō 275
 chokorēto 113
 chokorēto chippusu 141
 chokorēto kēki 140
 chokorēto mirukusēki 149
 chokorēto o kabueta 140
 chokorēto supureddo 135
 chōku 162
 chokuchō 21
 chokuryū denryū 60
 chokusen 165
 chōkyori basu 196
 chōnekutai 36
 chōmpa (kensa) 52
 chōmpa jettoki 211
 choppu 119
 chōri 67
 chōri niku 143
 chōri shitsu 214
 chōri yōgu 68
 chōri-zumi niku 118
 chōridai 66
 chorisō 143
 chōruui 292
 chōryū 130
 chōsa 94
 chōsei taku 179
 chōshin 304
 chōshinki 45
 chōshoku 64, 156
 chōshoku byuffe 156
 chōshoku no tēburu 156
 chōshoku torei 101
 chōshoku-tsuki 101
 chosui tanku 61
 chōten 164
 chōyaku-ban 235
 chōzai shitsu 108

chūba 257
 chūbei 314
 chūbu 207, 311
 chuchu 191
 chūdoku 46
 chūgaeri 235
 chūgoku 318
 chūha 179
 chūi 323
 chūka nabe 69
 chūkanken 286
 chūko hambaiten 115
 chūmon suru 153
 chunijia 317
 chūō afurika kyōwakoku 317
 chūō bunri-tai 194
 chūō enzan shori sōchi 176
 chūō shasen 194
 chūrippu 111
 chūsha 48
 chūsha kinshi 323
 chūsha suru 195
 chūsha-bari 109
 chūshajō 298
 chūshaki 109, 167
 chūshin 164
 chūshoku 64
 chūshukotsu 17
 chūsokkotsu 17

D

daburu 151
 daburu beddo 71
 daburu kurīmu 137
 daburu rūmu 100
 daburusu 230
 dachō 292
 daenkei 164
 daffurukōto 31
 dagakki 257
 dagu-auto 229
 daichi 284
 daichō 18
 daidenkin 16
 daidokoro 66
 daidokoro yōhin 105
 daigaku 168, 299
 daigakuin 169
 daigakusei 169
 daihon 254
 daikaiten 247
 daikei 164
 daiku 188
 daimeie 168
 dainamo 207
 dainingu rūmu 64
 daiō 127
 dairi 223
 dairiseki 288
 daiseidō 300
 daitai ryōhō 54
 daitaikotsu 17
 daiuikyō 133
 daiya 273
 daiyamondo 288
 daizu 131
 damī 276

dampukā 187
 damu 300
 danberu 251
 danchigai heikōbō 235
 dankushūto suru 227
 danmenzu 282
 danro 63
 dansā 191
 danseie 12, 13, 21, 23
 danseie fuku 32
 danshi seito 162
 dansu 259
 dasshubōdo 201
 dassui suru 76
 dassuiki 76
 dasutā 77
 dāto baiku 205
 dātsu 273
 dātsubōdo 273
 daunrōdo suru 177
 de 320
 debitto kādo 96
 deddōbōru rain 221
 deguchi 322
 deguchi rampu 194
 dejitaru kamera 270
 dekki 85
 dekki chea 265
 dempō 98
 den'atsu 60
 denchi 167, 260
 denchi paku 78
 dengem 60
 dengem kēburu 176
 dengem sōchi 266
 denki doriru 78
 denki kamisori 73
 denki kigu 66
 denki seihin 105, 307
 denki setsubi 60
 denki yakan 66
 denkikō 188
 denkimōfu 71
 denkyū 60
 denmāku 316
 denriken 286
 denyoku 60
 denyokuryō-kei 60
 densen 60
 densha 208
 denshimēru 177
 denshirenji 66
 denshitechō 175
 dentaku 165
 dentaru furosu 50, 72
 dentaru furosu de sōji suru 50
 denwa 99, 172
 denwa ni deru 99
 denwa suru 99
 deodoranto 73, 108
 depāto 105
 derikatessen 107, 142
 desukutoppu 177
 desukutoppu ōganaizā 172
 dezainā 191, 277
 dezāto 153

dezāto wagon 152
 di-bui-di disuku 268
 di-bui-di purēyā 268
 difendingu zōn 224
 dijitaru 269
 dijon masutādo 135
 diru 133
 disuku 176
 disuku jokki 179
 diwāri 27
 dizeru 199
 dizeru kikansha 208
 dō 235, 289
 doa 196, 198, 210
 doa handoru 200
 doa mirā 198
 doa rokku 200
 doachēn 59
 doanokkā 59
 dōbā karei 120
 dōbutsu 290, 292, 294
 dōbutsuen 262
 dōbutsugaku 169
 dōgu 187
 dōgubako 80
 doitsu 316
 dojō 85
 dokku 214, 216
 dōkō 51
 dokubari 295
 dokusho risuto 168
 dokusho-tō 210
 dōkutsu 284
 dokyumentarī 178
 dokyumento fairu 173
 dōmā 58
 dominika 314
 dominika kyōwakoku 314
 domino 273
 dōmyaku 19
 donabe 69
 donaru 25
 donguri kabocha 125
 dora 257
 dorai furawā 111
 dorai furūtsu 129, 156
 doraibā 80
 doraibā bitto 80
 doraibāshotto o utsu 233
 doramā 258
 doramu 258
 doramu setto 258
 doreshshingu o kaketa 159
 doriburu suru 222
 doriru 50
 doriru bitto 78, 80
 dōro 194
 dōro hyōshiki 195, 298, 323
 dōro kōji 187, 195
 dōro kōji-chū 323
 doroppu shotto 230
 doroyoke 205
 dōru hausu 75
 dōryō 24
 doseie 280
 dōtsuki noko 81
 doyōbi 306

dōzo 322
 dyūsu 230

E

e 36, 62, 187, 274, 320
 ē tī emu 97
 ē-pī-esu kamera 270
 ea firutā 202, 204
 eā mattoresu 267
 eabaggu 201
 eakon 200
 earobaiku 250
 earobikusu 251
 echiofia 317
 eda 296
 eda tsuno 291
 edage 39
 edamu chizu 142
 edawake suru 91
 efude 274
 egaku 162
 eggu kappu 65, 137
 ehagaki 112
 ei 294
 eiga 255
 eiga no setto 179
 eigakan 255, 299
 eigyō bu 175
 eihō 239
 eikō-sen 215
 eikoku 316
 eiseie antena 269
 eishamaku 255
 eijiputo 317
 eijii 246
 eki 208
 ekika 127
 ekitai keiryōki 311
 ekitai senzai 77
 ekitai-gusuri 109
 ekonomī kurasu 211
 ekuadoru 315
 ekubo 15
 ekuiti 97
 ekurea 140
 emarushon 83
 emban-nage 234
 embosu kabegami 83
 emerarudo 288
 empitsu 163, 275
 empitsu-kezuri 163
 emu di efu 79
 emu-pī-suri purēyā 268
 enamerushitsu 50
 enchō jikan 223
 enchō kōdo 78
 enchō suru 168
 enchū 164
 endaibu 123
 endo zōn 220
 endōmame 122
 endorain 226
 engan-keibitai 217
 engeie 90
 engeie sentā 115
 engeie yōhin 88
 engeie-yō tebukuro 89

enjin 202, 204, 208, 210
 enjo 322
 enkeie 164
 enkin ryōyō 51
 enko 164
 enogu 274
 enshi 51
 ensūhō 164
 ensui 164
 entotsu 58, 214
 epuron 30, 50, 69, 212
 era 294
 erēbētā 59, 100, 104
 erekigita 258
 eri 32
 eritoria 317
 erizukami 237
 erusarubadoru 314
 esa 244
 esa o ataeu 183
 esharotto 125
 ēsu 230, 273
 esu-efu eiga 255
 esukarētā 104
 esuppresso 148
 esute 41
 esutonia 316
 etchingu 275
 etsuran shitsu 168
 etsuran suru 177

F

faitto 257
 faindā 271
 fairingu kyabinetto 172
 fairu 172, 177
 faiyā sukurin 63
 fakkusu 172
 fam beruto 203
 famburu 220
 fan 202, 258
 fandēshon 40
 fanhitā 60
 fashon 277
 fasunā 277
 fāsuto fūdo 154
 fauru 223, 226
 fauru bōru 228
 fauru rain 229
 feaweie 232
 feijoa 128
 feisu 230
 fenshingu 249
 fenuguriku 132
 ferī 215, 216
 ferī noriba 216
 fēsharu 41
 fēsu kurīmu 73
 fēsu masuku 225
 fēsu paku 41
 fēsu-ofu sākuru 224
 figyuasukēto 247
 fiji 319
 finrando 316
 firamento 60
 firipin 319
 firos pesutorī 140

- firudinguru suru 229
 firudo hokkē 224
 firumu 260, 271
 firumu kauntā 270
 firutā 270
 firutā kōhi 148
 fīto 310
 fittonesu 250
 fittonesu kigu 250
 fō doa 200
 foahando 231
 fōku 65, 88, 153, 207
 fōku 259
 fōku rifuto 186
 fōkurando shotō 315
 fōkurifuto 216
 fōmaru-na teien 84
 fonto 177
 foruda 177
 foruto 230
 fowādo 222
 fuan 25
 fuchi'ishi 298
 fudansō 123
 fudebako 163
 fūdo 31, 75
 fūdopurososā 66
 fudōsan-ya 115, 189
 fuhenkashi 320
 fujin fuku 105
 fujin-ka 49
 fujinka-i 52
 fukami 239
 fuke 39
 fukikesu 141
 fukkatsusai 27
 fukkin 16
 fukkin undō 251
 fukku 187
 fuku 77
 fukuboku 47
 fukurahagi 13
 fukurashiko-iri komugiko
 139
 fukureru 139
 fukuro 291, 311
 fukurō 292
 fukusayō 109
 fukusha suru 172
 fukushin 223
 fukusōjūshi 211
 fukutsū 44
 fukuyōki 211
 fukyoku 167
 fuminshō 71
 fun 304
 fune 214
 funinshō 20
 funka suru 283
 funkakō 283
 funkikō 290
 funmatsu senzai 77
 funmu suru 91
 funnyū 137
 funōshō 20
 funsui 85
 furaggu 232
- furaggu posuto 221
 furai 244
 furai fīshingu 245
 furaido chikin 155
 furaido poteto 154
 furaigaeshi 68
 furaipan 69
 furaishito 266
 furajore mame 131
 furamingo 292
 furan 142
 furansu 316
 furashi 244
 furasshu gan 270
 furasoku 166
 furatto 216
 furatto uddo bitto 80
 furattobureddo 139
 furēku 132
 furēmu 51, 206, 267
 furenchi horun 257
 furenchi puritsu 39
 furenchi tōsuto 157
 furette 258
 furi kikki 222
 furi weito 250
 furijia 110
 furippā 239
 furippu chāto 174
 furisu 74
 furisurō rain 226
 furizu 301
 furo ni hairu 72
 furonto 100
 furonto garasu 198
 furonto garasu senjōeki 199
 furonto-gakari 100
 furorentin 141
 furōzun yōguruto 137
 furui 89, 321
 furui ni kakeru 91, 138
 furūre 249
 furūto 257
 furūtsu gamu 113
 furūtsu kēki 140
 furūtsu pan 139
 furūtsu sarada 157
 furūtsu taruto 140
 furūtsu yōguruto 157
 fusa 122, 126
 fūsui 55
 fusuma 130
 futa 61, 66, 69
 futago 23
 fūtō 98, 173
 futoi 321
 futomomo 12
 futon 71
 futōzai 199
 futsū 39, 99
 futsuryō giana 315
 futsūyokin kōza 96
 futtobōdo 71
 futtobōru kyōgijō 220
 futtobōru senshu 220
 futtosutorappu 241
 fuyu 31, 307
- G**
 ga 295
 gābera 110
 gabon 317
 gabyō 173
 gachō 119, 293
 gachō no tamago 137
 gādo rēru 195
 gādo shita tsūro 194
 gaido-tsuki tsuā 260
 gaika 97
 gaikaku 282
 gaikan 28
 gaikiken 286
 gaikokugo 162
 gairaikanja 48
 gaishoku 146
 gaishutsu 75
 gaisō 198
 gaitō 298
 gaiya 229
 gaka 191, 274
 gake 285
 gakkī 256, 258
 gakkō 162, 299
 gakkō no seifuku 162
 gakkotsu 17
 gaku 297
 gakubu 169
 gakubuchi 62
 gakufu 255, 256
 gakugyō 162
 gakui 169
 gakui-rombun 169
 gakumen kingaku 97
 gakumen 163
 gakusei ryō 168
 gakusei shokudō 168
 gakashū 160
 gambia 317
 gamen 97, 176, 269
 gamu 113
 gan-ka 49
 gāna 317
 gānetto 288
 gangiei 120, 294
 gangiei no hire 120
 ganka 49
 ganseki 288
 garagara 74
 gārando 111
 garapagosu shotō 315
 garasu bin 166
 garasubō 167
 garasusei 69
 gārīkku puresu 68
 garon 311
 gārūfurendo 24
 gasorin 199
 gasorin pompu 199
 gasorin sutando 199
 gasu konro 267
 gasubānā 61
 gasuketto 61
 gasurenji 67
 gātā 35
- gatto 230
 gaun 38
 gazai-ya 115
 gāze 47
 gedan 141
 geka 49
 geka-i 48
 geki 254
 gekijō 254, 299
 gekkei 20
 gembugan 288
 gēmu 230, 272, 273
 gēmu bangumi 178
 gen 258
 gengakki 256
 genkan 59
 genkan matto 59
 genkan-tō 58
 genmai 130
 genmon 214
 gensō 214
 genzai 304
 genzō suru 271
 gerende 246
 gerende-gai 247
 geri 44, 109
 gesen suru 217
 gesuidō 299
 gēto bangō 213
 getsuyōbi 306
 gezai 109
 gia bokkusu 202, 204
 giana 315
 gibo 23
 gibusu 46
 gichō o tsutomeru 174
 gidai 174
 gifu 23
 gifuto shoppu 114
 gijiroku 174
 gikyōdai 23
 gin 235, 289
 gingakei 280
 ginia 317
 giniabisau 317
 ginkō 96
 ginkō furikomi 96
 ginkō tesūryō 96
 giri no shimai 23
 girisha 316
 gishigishi 123
 gitarisuto 258
 go 308
 go banme 309
 gōban 79
 gogatsu 306
 gogo 305
 gōguru 238, 247
 gohan 158
 gohan-jawan 64
 gohyaku 308
 gojū 308
 gojū banme 309
 gokakkei 164
 gokiburi 295
 goma 131
 goma'abura 134
- goman 309
 goman gosen gohyaku 309
 gomi okiba 266
 gomibako 61, 67, 172, 177
 gomishori 61
 gomishori-ki 61
 gomubōto 215
 gomuin 173
 gomunagagutsu 89
 gomuzōri 37
 goraku 252
 goraku kaden 268
 gorira 291
 gōru 221, 222, 223, 224, 234
 gōru eria 223
 gōru netto 226
 gōru rain 220, 223, 224
 gōru ringu 226
 gorufā 232
 gorufu 232
 gorufu baggu 233
 gorufu bōru 233
 gorufu kato 232
 gorufu kōsu 232
 gorufu kurabu 233
 gorufu shūzu 233
 gōrukupā 222, 224
 gōruposuto 220, 222
 gōsei sen'i 31
 gosenufu 256
 goshigoshi arau 77
 goshikku 301
 goshin 237
 gu 140, 155
 guaba 128
 guatemala 314
 gun'yō 110
 guraidā 211, 248
 guraidingu 248
 gurajiorasu 110
 guranu 310
 guranari bureddo 139
 gurando 234
 gurando kabā 87
 gurando shito 267
 gurasu 150, 152
 guratan-zara 69
 gurauto 83
 gurē 39
 gurenada 314
 gurēpu jūsu 144
 gurēpufurūtsu 126
 gurēzu o nuru 139
 gurin 232
 gurin pīsu 131
 gurin sarada 158
 gurinrando 314
 gurippu 230
 gurirupan 69
 gurōbu 224, 233, 237, 246
 gurū gan 78
 gurujia 318
 gurūpu ryōhō 55
 gūzuberī 127
 gyokō 217
 gyōmu 183
 gyōretsū 27

- gyorui 294
gyosen 217
gyūniku 118
gyūnyū 136, 156
gyūnyū katon 136
- H
ha 50, 89, 122, 296
ha no teire 72
haba 165
haba no hiroi 321
haba no semai 321
habu 206
hābu 86, 133, 134
hābu cha 149
hābu no bōdā kadan 85
hābu to kōshinryō 132
hābu-en 84
haburashi 72
hachi 295, 308
hachi banme 309
hachidori 292
hachigatsu 306
hachijū 308
hachijū banme 309
hachō 179
hachūruui 293
hada no iro 41
hadagi 30, 33
hādo chizu 136
hādo doraibu 176
hādobōdo 79
hādorosō 235
hādowea 176
hae 295
hafu 300
hāfu taimu 223
hagasu 82
hageatama 39
haguki 50
haha 22
hai 18, 52, 322
hai'iro 274
haichea 75
haichi 314
haidenki 203
haigūsha 23
haihiru 37
haikan setsubi 61
haikankō 188
haikei 254
haiki-kan 203, 204
haikingu 263
haikingu būtsu 37, 267
hairaito 39
hairan 20, 52
haisha 50, 189
haisui 91
haisuikan 61
haisuikō 72, 299
haisuikokku 61
haita 50
haitatsu 98
haitō 97
haiyaku 254
haiyū 179, 191, 254
haizara 150
- hajime 321
hakari 69, 98, 118, 310
hakarū 310
hakase gō 169
hake 69, 83
hakike 44
hakka 133
hakka ame 113
hakkakkei 164
hakkō saseru 139
hako-gata fairu 173
hakozone chokorēto 113
haku 44, 77, 90
hakua 288
hakubutsukan 261
hakuchō 293
hakumai 130
hakunaishō 51
hakurikō 139
hakusai 122
hakushu suru 255
hamaki 112
hambāgā 154, 155
hambāgā-ya 154
hami 242
hamigaki suru 50
hamigaki yōhin 108
hamigakiko 72
hammoku 266
hamu 119, 143, 156
hamusutā 290
hamusutoringukin 16
hana 14, 110, 291, 293, 297
hana no ana 14
hana sen 238
hana-gawa 242
hanabira 297
hanaji 44
hanareya 182
hanashiau 163
hanashigai no 118
hanasu 245
hanataba 111
hanawa 111
hanaya 110, 188
handa 79, 81
handagote 81
handazuke suru 79
handikyappu 233
hando doriru 78, 81
hando fōku 89
hando taoru 73
handobaggu 37
handoburēki 303
handoru 201
handorubā 207
hane 60, 293
hanebuton 71
hanemūn 26
hanga 275
hangā 70
hangari 316
hangigo 320
hangingu basuketto 84
hangu guraidā 248
hangu guraidingu 248
hanikamu 25, 134
- hankachi 36
hankei 164
hanken 96
hanketsu 181
hansen 215
hanshakyō 50, 167
hanshazai 205
hantō 282
hanzai 94
hanzai-reki 181
hanzai-sha 181
hanzubon 30
happō 144
happyaku 308
hāpu 256
hara 12
harai 237
haraobi 242
hare 286
hari 186, 276
hari ita 276
hari ni kakaru 245
hari ryōhō 55
harigane 79
harikēn 287
hariko 191, 275
harinezumi 290
harisashi 276
harowin 27
haru 307
hasami 38, 47, 82, 188, 276
hashi 64, 300
hashigo 95, 186
hashika 44
hashira 300
hashirihabotobi 235
hashiritakatobi 235
hashiru 229
hassha 281
hasshadai 281
hasui suru 52
hata 277
hatake 182
hataori 277
hatchibakku 199
hato 292
hātō 273
hatoba 216
hatoba ni tsukeru 217
hatsudenki 60
hatsukanezumi 290
hatsunetsutai 61
hawai 314
haya'ashi 243
hayabusa 292
hayai 305, 320, 321
hayaokuri 269
hazādo rampu 201
hazukashi 25
hazumi-guruma 276
hazuna 243
hea karā 39
heabando 38
heaburashi 38
headoraiyā 38
heakarā 40
heapin 38
- heasupurē 38
heatai 39
hebi 293
hebi metaru 259
hechima 73
heddo raito 198, 205
heddo resuto 200
heddobōdo 70
heddogādo 236
heddohon 268
heddosēru 240
hedingu suru 222
heichi kyōsō 243
heihō fito 310
heihō mētoru 310
heikan 260
heikindai 235
heikōbō 235
heikōsen 165
heikōshihenkei 164
heimen kikagaku-shiki teien 262
heimenzukei 164
heishi 189
heiya 285
hekimen shōmei 62
hemataito 289
hen'atsuki 60
hengan 288
henkyaku-bi 168
henmagan 288
henseigan 288
henshū-sha 191
hensoku ki 202, 206
hensoku rebā 201
hensoku suru 207
henzutsū 44
heon kigō 256
hera 68, 167
herikoputā 211
herumetto 95, 186, 204, 206, 220, 228, 242
heso 12
hesono'o 52
heya 58
heya bangō 100
heya no kagi 100
hēzerunattsu 129
hēzerunattsu oiru 134
hi o tsukeru 266
hi'iragi 296
hidari 260
hidari desu 323
hidari handoru 201
hidokei 262
hifu 14
hifu-ka 49
hifukukin 16
higashi 312
higashi timōru 319
hige 290
higesori 73
higesori kurīmu 73
higisha 180
hiji 13
hijikake 210
hijō kaidan 95
- hijō rebā 209
hijō-guchi 210, 322
hikaekabe 301
hikidashi 66, 70, 172
hikiageru 294
hikiniku 119
hikinobashi 271
hikiwake 223
hikiyoseru 245
hikōki o yoyaku suru 212
hikoku-gawa 181
hikokunin 181
hikotsu 17
hiku 165
hikui 321
himaraya sanmyaku 313
himarayasugi 296
himawari 184, 297
himawari abura 134
himawari no tane 131
himeji 120
himpan ni 320
hinagiku 110, 297
hinichi 306
hinin 21
hinode 305
hinyōki kei 19
hinyōki-ka 49
hiraite 321
hiraoyogi 239
hiraya 58
hire ashi 290
hire niku 119
hiroba 299
hirokuchi bin 311
hiryō 91
hiryō o yaru 91
hishi no mi 124
hishigata 164
hisu 297
hisui 288
hitā 60
hitā chōsetsu 201
hitai 14
hitai-gawa 242
hito 10
hitode 295
hitokire 140
hitoribun 64
hitosashiyubi 15
hitsuji 185
hitsuji no mure 183
hiyake 41, 46
hiyake rōshon 265
hiyakedome 108, 265
hiyoke-bō 30, 265
hiyoko 185
hiyoko mame 131
hiza 12
hiza-take 34
hiza'ate 205
hizō 18
hizume 242, 291
hō 14
ho'on uea 267
ho'onzai 61
hobākura futo 215

hōbeni 40
 hochikisu 173
 hōchō 68
 hōchō togi-ki 68
 hodō 262, 298
 hōdō 178
 hodoku 277
 hofuku shokubutsu 87
 hōgaku 169
 hōgannage 234
 hōgō 52
 hogo megane 81
 hōhi 21
 hoikuki 53
 hoippu kurimu 137
 hoiru 207
 hoīru kyappu 202
 hoīru natto 203
 hojorin 207
 hojoyoku 210
 hōkaiseki 289
 hoken 203
 hoketsusenshu 223
 hōki 77
 hokkai 312
 hokkē 224
 hokkē-yō sutikku 224
 hokkyoku 283
 hokkyokuguma 291
 hokkyokukai 312
 hokkyokuken 283
 hōkō shijiki 198, 204
 hōkōda 210
 hōkokusho 174
 hokori o harau 77
 hokoru 25
 hokōsha-tengoku 299
 hokubei 314
 hokuro 14
 hokyū suru 220, 229
 homeopashi 55
 homojinaizu 137
 hōmu 208
 hōmu bangō 208
 hōmu bēsu 228
 hōmu bu 175
 hon 168
 hon'i kigō 256
 hon'ya 115
 hondana 63
 hone 17, 119, 121
 hone o totta 121
 honjurasu 314
 honsha 175
 honsō-gaku 55
 honyūbin 75
 honyūru 290
 horā eiga 255
 hōrensō 123
 hori 300
 hōritsu 180
 hōritsu jimusho 180
 hōritsu sōdan 180
 horu 90
 hōru 232
 hōru in wan 233
 horumon 20

hōrutā nekku 35
 hōseki 36, 288
 hōseki-bako 36
 hōseki-shō 188
 hōseki-ten 114
 hoshakukin 181
 hōshasen-ka 49
 hoshi 280
 hoshibudō 129
 hoshikusa 184
 hōsō 179
 hōsō suru 178
 hōsō-shi 111
 hosoi 321
 hosshin 44
 hōsu 89, 95
 hōsu rīru 89
 hōtai 47
 hotategai 121
 hōtei 180
 hōtei kakari-kan 180
 hoteru 100, 264
 hotto doggu 155
 hotto kokoa 144, 156
 howaitingu 120
 howaito 39
 howaito chokorēto 113
 howaitokaranto 127
 hozon shori 118, 143, 159
 hozon suru 177
 hyakkajiten 163
 hyaku 308
 hyaku banme 309
 hyakubunritsu 165
 hyakujū 308
 hyakuman 309
 hyō 286
 hyōdo 85
 hyōga 284
 hyōhakuza 77
 hyōketsu 287
 hyōshiki 322
 hyōshō dai 235
 hyūzu 60
 hyūzu bokkusu 203

I

i 18
 ibiki o kaku 71
 ibuningudoresu 34
 ichi 308
 ichi banme 309
 ichi-ji han 304
 ichi-ji jūgo-fun 304
 ichiba 115
 ichigan-refu kamera 270
 ichigatsu 306
 ichigo 127
 ichigo no mirukusēki 149
 ichijiku 129
 ichijiteishi 269
 ichiman 309
 ichinensō 86
 ichirin daisha 88
 ido 283
 ie 322
 iemen 318

ierō kādo 223
 igaku 169
 igo 320
 iguana 293
 igunisshon 200
 igusa 86
 ika 121, 295
 ikari 214, 240
 ikari o orosu 217
 ike 85
 ikegaki 182
 ikikata 260
 ikkai 104
 ikkai seki 254
 ikkodate 58
 ikōru 165
 ikutsuka no 320
 ima 62, 320
 imin suru 26
 imomushi 295
 in-gōru 221
 inago 295
 inazuma 287
 inchi 310
 indekkusu 173
 indo 318
 indonesia 319
 indoyō 313
 infuruenza 44
 inga 271
 ingashi 271
 ingenname 122, 313
 ingurisshu burekkufāsuto 157
 ingurisshu horun 257
 ingurisshu masutādo 135
 iningu 228
 inko 293
 inku 275
 innō 21
 insatsu suru 172
 insei shokubutsu 87
 inshin 20
 insurin 109
 insutanto kamera 270
 insutanto shokuhin 107
 insutōru suru 177
 intabyūā 179
 intāhon 59
 intānetto 177
 intāshiti ressha 209
 intō 19
 inu 290
 inu-zori suberi 247
 iō 289
 ippōtsūkō 194, 298, 323
 iraku 318
 irakusa 297
 iran 318
 ireba 50
 ireru 76
 irezumi 41
 iriguchi 59, 322
 iro 274
 iro-empitsu 163
 iroai 41
 iroguro 41
 irojiro 41

iruka 290
 iryō bumon 49
 iryō sentā 168
 ise ebi 121
 isha 45, 189
 ishikifumei 47
 ishō 255
 isozuri 245
 isu 64
 isuraeru 318
 itachoko 113
 itameru 67
 itameta 159
 itami-dome 47, 109
 itaria 316
 ito 276
 ito annai 276
 ito maki 276
 ito o tōsu 277
 itoko 22
 itonoko 81
 itsū 44
 itsumo 320
 itta 129
 itten ageru 223
 iwa 284
 iwashi 120
 iyakuhin 109
 iyaringu 36
 izen 320
 izeru 174, 274

J

jagaimo 124
 jaguchi 61, 66
 jaketto 34
 jakki 203
 jakku 273
 jamaika 314
 jampu 243, 247
 jampu bōru 226
 jampu suru 227
 jamu 156
 jānarisuto 191
 janguru jimu 263
 jankushon 194
 jari 88
 jazu 259
 jeru 38, 109
 jetto 288
 jetto kōsutā 262
 jettosuki 241
 ji 304
 ji'in 300
 jibi'inkō-ka 49
 jidō doa 196
 jidō hikiotoshi 96
 jidōsha 198, 200
 jidōsha jiko 203
 jidōsha rēsu 249
 jigusō 78
 jigusō pazuru 273
 jikan 234, 261, 304
 jikan-dōri 305
 jikayō jettoki 211
 jikken 166
 jikken shitsu 166

jiko 46
 jiko saikō kiroku 234
 jikokuhyō 197, 209, 261
 jimbabue 317
 jimu 101
 jimu kiki 172
 jimu yōhin 173
 jimusho 172, 174
 jin 145
 jinji bu 175
 jinkōeisei 281
 jinsei 26
 jintai 17
 jintai keitō 19
 jintonikku 151
 jintsū 52
 jintsū sokushin suru 53
 jinzō 18, 199
 jioputā 51
 jipan 31
 jipuchi 317
 jishaku 167
 jishin 25, 283
 jisho 163
 jitensha 206
 jitensha ni noru 207
 jitensha raku 207
 jitensha-dō 206
 jizai supana 80
 jō 59
 jōba 242, 263
 jōba muchi 242
 jōba zubon 242
 jōba-dō 263
 jōba-gutsu 242
 jōgi 163, 165
 jōgingu 251, 263
 jōkā 273
 jōki kikansha 208
 jōkō eki 41
 jōkyoku 256
 jōmuin 210
 jōmyaku 19
 jōro 89
 jōryokuju 86
 josampū 53
 josei 12, 20, 23
 josei fuku 34
 jōsen suru 217
 jōsen-guchi 281
 jōshaken 197
 joshi seito 162
 jōso 181
 josō suru 91
 josōzai 91, 183
 jōwankotsu 17
 joyū 254
 jōzai 109
 jū 308
 jū banme 309
 jūden-shiki doriru 78
 jūdō 236
 jueri seisaku 275
 jūgatsu 306
 jūgo 308
 jūgo banme 309
 jūgo-fun 304

jūgyō 163
 jūgyōin 24, 175
 jūgyōin meibo 175
 jūhachi 308
 jūhachi banme 309
 juhi 296
 jūi 189
 jūichi 308
 jūichi banme 309
 jūichigatsu 306
 jūku/jūkyū 308
 jūkyū banme 309
 jūman 309
 jumbi undō o suru 251
 jūnan shiagezai 76
 jūnana banme 309
 jūnenkan 307
 jūni 308
 jūni banme 309
 jūnigatsu 306
 jūnishichō 18
 juncan kei 19
 junyū 53
 junyū burajā 53
 junyū suru 53
 jūoku 309
 jūroku 308
 jūroku banme 309
 jūryoku 280
 jūsan 308
 jūsan banme 309
 jusei 20
 jūshi/jūyon 308
 jūshichi/jūnana 308
 jushin suru 177
 jushin-bako 177
 jūsho 98
 jūsu 149
 jutai 52
 jūtaku 58
 jūtaku rōn 96
 jūtaku-nai setsubi 160
 jūtan 63
 jūtenzai 83
 juwaki 99
 jūyon banme 309

K

ka 295
 kā ōdio 201
 ka'atsutai 45
 kaba 291
 kaban uriba 104
 kabe 58, 186, 222
 kabegami 82, 177
 kabegami o harikaeru 82
 kabegami o haru 82
 kabegami-bake 82
 kabegami-yō nori 82
 kabin 63, 111
 kabinda 317
 kābingu fōku 68
 kabocha 125
 kabocha no tane 131
 kabu 97, 124
 kabuka 97
 kabushiki 97

kabutomushi 295
 kachiku 182, 185
 kachinko 179
 kadan 85, 90
 kādigan 32
 kadō 283
 kādo 27
 kādo sōnyū-guchi 97
 kādo-shiki kōshū-denwa 99
 kaede 296
 kaeru 294
 kaeshi 244
 kafe 148, 262
 kafe puresu 65
 kafunshō 44
 kafusubotan 36
 kagaku 162, 166
 kagakusha 190
 kagami 63, 71
 kagi 59, 207
 kagi hokku 276
 kagibari 277
 kagibariami 277
 kago 106, 207
 kagu 105
 kaguya 115
 kai'in sekkai 52
 kaibaake 183
 kaichūdēntō 267
 kaidan 59
 kaidan no tesuri 59
 kaiga 261
 kaigan 285
 kaigara 265
 kaigi 174
 kaigi shitsu 174
 kaigi wa nanji desuka 174
 kaijo bumben 53
 kaikan 260
 kaikan jikan 322
 kaikei 152
 kaikeishi 97, 190
 kaimono 102
 kaimono-bukuro 106
 kaiōsei 280
 kairopurakutikku 54
 kaisambutsu 121
 kaisatsu-guchi 209
 kaisha 175
 kaisui pantsu 238
 kaiten 238, 247
 kaiten isu 172
 kaitō suru 67
 kaiyō teikisen 214
 kaji 95, 241
 kaji bō 240
 kajino 261
 kajū 127
 kajuaruwa 33, 34
 kajuen 183
 kakaku 199
 kakaku hyō 154
 kakashi 184
 kakato 13, 15, 37
 kake 273
 kakeashi 243
 kakeru 165

kaki 121, 128, 239
 kakimawasu 67
 kakine 85, 90, 182
 kakitome yūbin 98
 kakkō 247
 kakō 285
 kakō kokumotsu 130
 kakōgan 288
 kaku 162
 kaku-gōri 151
 kakudai suru 172
 kakudo 164
 kakumaku 51
 kakusei sōchi 209
 kakushitsu jokyo suru 41
 kakusui 164
 kakuteru 151
 kakutōgi 236
 kamakiri 295
 kamanbēru chizu 142
 kamban 104
 kambō 181
 kambojia 318
 kambu 174
 kame 293
 kamera 178, 260, 270
 kamera dai 178
 kamera kēsu 271
 kamera-ya 115
 kameraman 178
 kamerūn 317
 kami 14, 38
 kami omutsu 30
 kami paku 311
 kami yasuri 81
 kamigata 39
 kamikizu 46
 kaminari 286
 kamisori no ha 73
 kamiyui 38
 kamo 119, 185
 kamome 292
 kamomiru cha 149
 kamotsu 216
 kamotsu ressha 208
 kamotsu-sen 215
 kampai 323
 kampan 214
 kampari 145
 kamu beruto 203
 kamukōdā 260, 269
 kan 145, 202, 311
 kan inryō 154
 kan'yō shokubutsu 87
 kånabi 201
 kanada 314
 kanamonoya 114
 kanariya 292
 kanashi 25
 kanazuchi 80
 kanden 46
 kandokku 217
 kånēshon 110
 kanfū 236
 kangarū 291
 kangofu 45, 48, 52, 189
 kani 121, 295

kånibaru 27
 kaniku 124, 127, 129
 kanja 45
 kanjō 25
 kanjō kōsaten 195
 kanjuku 129
 kanketsusen 285
 kankikō 210
 kankin suru 97
 kankiri 68
 kankisen 66
 kankitsu rui 126
 kankō 260
 kankō annai-jo 261, 322
 kankō annaisho 260
 kankō basu 197, 260
 kankō gaido 260
 kankō kyaku 260
 kankō meisho 260
 kankō rūto 260
 kankoku 318
 kankyaku 254
 kankyō 278
 kanmi supureddo 134
 kanna 81
 kanna o kakeru 79
 kannakuzu 78
 kannuki 59
 kanri jimusho 266
 kansan ritsu 97
 kanseitō 212
 kansen 44
 kansetsu 17
 kanshasai 27
 kanshi 53, 167
 kanshi'in 265
 kanshitō 265
 kanshu 181
 kanshū 233
 kansō 129, 130
 kansō hada 41
 kansō shita 286
 kansō shitsu 39
 kansōki 76
 kantan na 321
 kantoku 254
 kantorī 259
 kanū 214, 241
 kanzō 18
 kanzō ame 113
 kanzume 107
 kanzume yōki 311
 kao 14
 kaori no aru 130
 kāpetto 71
 kapoeira 237
 kappu-gata yōki 311
 kappuru 24
 kapuchīno 148
 kapuseru 109
 kara 129, 130, 137
 kārā 38
 kara hanarete 320
 kara no 321
 kara o muita 129
 karada 12
 karai 124

karakuchi 145
 karamatsu 296
 karanto 129
 karashi no tane 131
 karasu 292
 karasumugi 130
 karate 236
 karē 158
 karēko 132
 karendā 306
 kari'ireru 183
 karibukai 312
 karidashi 168
 karifurawā 124
 karikomi-basami 89
 karikomu 90
 kāringu 247
 kariningurādo 316
 karinui suru 277
 kariru 168
 karishakuhō 181
 kārū 39
 kārū airon 38
 karudamon 132
 karui 321
 karushi 73, 288
 karūseru 212
 karushiumu 109
 karute 48
 kasa 36, 233
 kasai keihōki 95
 kase 277
 kasei 280
 kaseigan 288
 kasetto purēyā 269
 kasetto tēpu 269
 kashi 113, 259, 296
 kashi rui 107
 kashidashi kauntā 168
 kashiya 113
 kashu 191
 kashūnattsu 129, 151
 kassōro 212
 kasu 58
 kasumisō 110
 kasupikai 313
 kasutādo 140
 kasutādo kurīmu 140
 kasutamā sābisu 104
 kata 13
 katagami 276
 katai 124, 129, 321
 katamaran 215
 katamari niku 119
 katārū 318
 katate nabe 69
 katatsumuri 295
 katei 56, 62
 katei saien 85
 katei yōhin 107
 kāten 63
 katēteru 53
 kātō 100, 106, 208, 213
 katsu 273
 katsudō 263
 katsura 39
 kattā 80

- kattā naifu 81
 kattēji chizu 136
 katto suru 38
 kauserā 55
 kauntā 96, 98, 100, 142, 150
 kawa 119, 126, 127, 128, 136, 142, 284
 kawa o muita 121
 kawa o muku 67
 kawagishi 284
 kawagutsu 32, 37
 kawaita 321
 kawajan 205
 kawakasu 76
 kawamuki-ki 68
 kawauso 290
 kaya 267
 kayakku 241
 kayōbi 306
 kazafusutan 318
 kazambai 283
 kazan 283
 kazari 141
 kaze 44, 241, 286
 kaze no tsuyoi 286
 kazoeru 165
 kazoku 22
 keana 15
 kebabu 155, 258
 kēburu 79, 207
 kēburu kā 246
 kēburu terebi 269
 kechappu 135
 kega 46
 keiba 243
 keibajō 243
 keibatsu 181
 keibi 212
 keibi'in 189
 keibō 94
 keibu 52, 94
 keido 283
 keiga kyōsō 243
 keihikōki 211
 keiji 94
 keijiban 173
 keikan 94, 189
 keikoku 284
 keikōtō 94
 keikotsu 17
 keimusho 181
 keiran 137
 keiri bu 175
 keiryō 310
 keiryō jagu 69
 keiryō kappu 311
 keiryō supūn 109
 keiryōki 150
 keiryū 285
 keiryū sakugu 217
 keiryū suru 217
 keisatsu 94
 keisatsusho 94
 keisei-geka 49
 keisenchū 214
 keishō 23
 keitai denwa 99
 keitai mēru 99
 keito 277
 keitsui 17
 keizaigaku 169
 kēki 140
 kēki to dezāto 140
 kēki yaki-gata 69
 kēki-zukuri 69
 kēkiya 114
 kekka 49
 kekkon hirōen 26
 kekkon suru 26
 kekkonshiki 26, 35
 kembikyō 167
 kemuri 95
 kemuri hōchiki 95
 ken 17
 ken'insha 203, 212
 kenchiku 300
 kenchiku yōshiki 301
 kenchiku zairyō 187
 kenchiku-ya 186, 188
 kenchikuka 190
 kendō 236
 kenia 317
 kenjū 94
 kenkasei teiboku 87
 kenkashokubutsu 297
 kenkō 42, 44, 323
 kenkō na 321
 kenkō shokuhin-ten 115
 kenkōkotsu 17
 kenkyū 169
 kenma suru 82
 kensa 49
 kensaku suru 177
 kensatsuin 209
 kensetsu 186
 kenshi 50
 kensui suru 251
 kenuki 40
 kēpā 143
 kerī 237, 239
 keru 221, 223
 kēru 123
 kesagatame 237
 keshi 297
 keshi no mi 138
 keshi'in 98
 keshigomu 163
 keshōdai 71
 keshōhin 41, 105, 107
 keshōsui 41
 kessai-bako 172
 kesshite nai 320
 kessoku himo 89
 kēsu 51
 keta 186
 ketchappu 154
 ketorodoramu 257
 ketsuatsu 44
 ketsuatsukei 45
 ketsueki kensa 48
 kezuru 79
 ki 86, 296
 ki 176
 ki'iro 274
 kiba 291
 kibi 130
 kibōdo 172, 176, 258
 kidō 280
 kifuhō 256
 kiji 119, 276, 293
 kikagaku 165
 kikai 187
 kikaikōzō 202
 kikan 18
 kikan shitsu 214
 kiken 195, 322
 kikkubokushingu 236
 kiku 110
 kikuimo 125
 kimi 157
 kimon 247
 kimono 35
 kimpōge 297
 kin 235, 289
 kin'en 322
 kin'en seki 152, 323
 kin'yōbi 306
 kin'yū 97
 kin'yū adobaizā 97
 kinembi 26
 kinenhi 261
 kingaku 96
 kingu 272, 273
 kingyo 294
 kinkan 126
 kinkan gakkī 257
 kinkyū chiryō-shitsu 48
 kinkyū denwa 195
 kinkyū sābisu 94
 kinkyūjitai 46
 kinniku 16
 kinō 306, 320
 kinoa 130
 kinri 96
 kinsei 280
 kinsen 97
 kinshi 51
 kinte surippu 173
 kinteki 273
 kintoki mame 131
 kinu 277
 kinzoku 79, 289
 kinzoku-yō bitto 80
 kion 286
 kīpaddo 97, 99
 kippu 209
 kippu uriba 209, 216
 kipurosu 318
 kirei na 321
 kiri 287
 kirieda 91
 kirifuku 89, 311
 kirigisutan 318
 kirikizu 46
 kirimi 119, 121
 kirin 291
 kiroguramu 310
 kiroku 234
 kiroku o yaburu 234
 kiromētōru 310
 kiru 67, 79, 273, 277
 kiru 214
 kirutingu 277
 kiruto 71
 kisuetsu 307
 kisetsu mono 129
 kishō 286
 kishu 210, 242
 kiso-gawa 180
 kissuisen 214
 kita 312
 kita chōsen 318
 kita hankyū 283
 kita kaikisen 283
 kitai 210
 kitanei 321
 kitchin 152
 kitsuen 112
 kitsuen seki 152
 kitsune 290
 kitsune-no-tebukuro 297
 kitsutsuki 292
 kitte 98, 112
 kitte shūshū 273
 kiwi 128
 kiza 242
 kizami-tabako 112
 kizetsu suru 25
 kizu 46
 kizuchi 275
 ko-azarashi 290
 ko-uma 185
 ko-ushi 185
 kō'unki 182
 koara 291
 kōbo 138
 kobu 291
 kōbu doa 198
 kōbu zaseki 200
 kōbu zaseki 204
 kobushi 15, 237
 kobuta 185
 kōcha 144, 149, 156
 kochira ga ue 98
 kōchō 217
 kōchō sensei 163
 kodachitomato 128
 kodara 120
 kōdo 211
 kōdō 169
 kodomo 23, 31
 kodomo fuku 30
 kodomo no ie 75
 kodomo yōhin uriba 104
 kodomobeya 74
 kōdoresu denwa 99
 koeda 296
 kōen 262
 kōenshō-zai 109
 kōfun suru 25
 kōgai 19, 299
 kōgaku 169
 kogamo 185
 kōgeki 220
 kogite 241
 kogitte 96
 kogitte-chō 96
 kogu 206, 207, 241
 kōgu sashi 186
 kōgu-dana 78
 kōgyōdanchi 299
 kōhaikin 16
 kōhan-bi 180
 kōhi 144, 148, 153, 156, 184
 kōhi mēka 148, 150
 kōhi mirukusēki 149
 kōhi supūn 153
 kōhi tēburu 62
 kōhi-fun 144
 kōhi-mame 144
 kōhikappu 65
 kohitsujī 185
 koi 294
 koin randorī 115
 koinu 290
 kōji gamba 186
 kōjō 299
 kōjōsen 18
 kōka 97
 kōka dōro 194
 kōka na 321
 kōka-shiki kōshū-denwa 99
 kōkai 313
 kokan 12
 kōkanshu 99
 kokka 315
 kokkai 313
 kokkaku 17
 koko 320
 kōkō suru 240
 kokoa paudā 148
 kōkoku 315
 kokonattsu 129
 kokotto 69
 kōkū bokan 215
 kokuban 162
 kōkūbin 98
 kokuen 289
 kōkūken 213
 kōkūki 210
 kokunai bin 212
 kokuritsu kōen 261
 kokuru 130
 kokuryū 130
 kokusai bin 212
 kokuso 94
 kokuyōseki 288
 kokyaku sābisu bu 175
 kōkyōkyoku 256
 kokyū 47
 kokyūki kei 19
 koma 272
 kōmaku-gai masui 52
 komamono 105
 komāsharu 269
 kombain 182
 kombanwa 322
 kome 130, 184
 komedi 255
 komekami 14
 komezu 135
 kōmi abura 134
 kōmi shefu 152

- komichi 58, 85
 kōmori 290
 komoro 317
 kompakuto 40
 kompakuto disuku 269
 kompakuto kā 199
 kompakuto mirā 40
 kompasu 165, 240, 312
 kompyūta 176
 komugi 130, 184
 komugiko 138
 komuragaeri 239
 komyunikēshon 98
 kōn yu 135
 kon'yakusha 24
 kon'yakusha 24
 kona chizu 136
 kōnā furaggu 223
 kōnā kikkū 223
 kona-gusuri 109
 kondishonā 38
 kondōmu 21
 koneko 290
 koneru 138
 kongo 317
 kongo minshu kyōwakoku 317
 kōnisu 300
 konkōsu 209
 konkurito burokku 187
 konkurito mikisā 186
 konnichiwa 322
 kōnotori 292
 konran suru 25
 konro 67
 konsāto 258
 konsento 60
 konshirā 40
 konshū 307
 konsome 158
 konsōru 269
 kontakutorenzu 51
 kontena 216
 kontena-sen 215
 kontenakō 216
 kontora fagotto 257
 kontorabasu 256
 kontorōrā 269
 koppu rui 65
 kōra 144, 293
 korāju 275
 korekuto kōru 99
 kōri 120, 287
 kōri nashi 151
 kōri to remon 151
 kōri-basami 150
 kōri-iri 151
 koriandā 133
 kōrin 197
 kōrogi 295
 korombia 315
 kōrudopuresu yu 135
 koruku sen 134
 koruku sennuki 150
 kōrurabi 123
 konusetto 35
 korushika 316
 kōryū denyū 60
 kōsai 51
 kōsaku nōjō 183
 kōsaten 298
 kōseki 289
 koshi 12, 169
 kōshi niku 118
 kōshinryō 132
 koshitsu 48
 koshō 64, 152, 203
 koshō no mi 132
 koshōchū 322
 kōshū-denwa bokkusu 39
 kosobo 316
 kōsoku bōto 241
 kōsoku dōro 194, 323
 kōsoku mōtābōto 214
 kōsoku ressha 208
 kossetsu 46
 kōsu ryōri 153
 kōsui 41
 kōsui uriba 105
 kosuritoru 77
 kosuru 77
 kōsutā 150
 kosutarika 314
 kotae 163
 kotaeru 163
 kōtaku 271
 kote 187
 kotēji gāden 84
 kōto 32, 226, 227
 kōtō 19
 kōtōgai 19
 kōtojibowāru 317
 kōtsū 192, 194
 kōtsū jūnsa 195
 kōtsū jūtai 195
 kotsuban 17,
 kotsufun 88
 kotton bōru 41
 kottōya 114
 kowagaru 25
 kōwan 214, 216
 kowaremono 98
 koyagi 185
 koyōnushi 24
 koyubi 15
 kōza bangō 96
 kōzai 79
 kōzan shokubutsu 87
 kozara 65
 kōzui 287
 kozutsumi 99
 ku/kyū 308
 kubaru 273
 kubi 12
 kubisujji 13
 kuchi 14
 kuchibashi 293
 kuchibeni 40
 kuchibiru 14
 kudamono 107, 126, 128
 kudamono jūsu 156
 kudamono kago 126
 kudōjiku 202
 kūfuku 64
 kugatsu 306
 kugi 80
 kui 90
 kuiki 299
 kuin 272, 273
 kujaku 293
 kujakuseki 289
 kujira 290
 kuki 111, 122, 297
 kūki ni sarasu 91
 kūki-doriru 187
 kūki're 207
 kukki 113
 kūkō 212
 kuma 291
 kumade 88
 kumin 132
 kumo 287, 295
 kumori 286
 kuni 315
 kunsei 118, 121, 143, 159
 kunsei nishin 157
 kuōto 311
 kura 242
 kurabu 273
 kurabu-sando 155
 kurabuhaisu 232
 kurage 295
 kurai 321
 kuraianto 180
 kurakushon 201, 204
 kurampu 78, 166
 kuranberī 127
 kurarinetto 257
 kurashikku kā 199
 kurashikku ongaku 255
 kurasshikku 259
 kurasupu 36
 kuratchi 200, 204
 kurejitto kādo 96
 kurementin 126
 kurēn 216
 kurēn-sha 187
 kurenzā 41
 kurēpu 155
 kureson 123
 kuri 129
 kuriketto 225
 kuriketto bōru 225
 kuriketto senshu 225
 kurīmu 109, 140, 157
 kurīmu chizu 136
 kurīmu hachimitsu 134
 kurīmu pai 141
 kūrīngu raku 69
 kurīningu-ya 115
 kurippubōdo 173
 kurīsu 225
 kurisumasu 27
 kurisupu bureddo 139, 156
 kurīto 240
 kuritorisu 20
 kuro 272, 274, 321
 kuro komugiko 138
 kuro obi 237
 kuro orību 143
 kuro pan 139, 149
 kuroachia 316
 kurōbā 297
 kurobīru 145
 kurōbu 133
 kurokami 39
 kurokodairu 293
 kurome mame 131
 kurōru 239
 kurosu torēnā 250
 kurosu-kantorī 247
 kurosubā 222
 kurowassan 156
 kurubushi-take 34
 kurumaebi 121
 kurumaisu 48
 kurumaisu taiō 197
 kurumi 129
 kurumi abura 134
 kusa 87
 kusachi 285
 kusatta 127
 kushami 44
 kushi 38, 68
 kushi de suku 38
 kussakuki 187
 kushon 62
 kusukusu 130
 kusurijubi 15
 kutsu 34, 37
 kutsu uriba 104
 kutsuhimo 37
 kutsuhimo ana 37
 kutsushita 33
 kutsuya 114
 kutsuzoko 37
 kuwa 88
 kuwēto 318
 kyabetsu 123
 kyabin 210
 kyadi 233
 kyaku 38, 64, 96, 104, 106, 152
 yakusha 208
 yakushitsu 100, 209
 yakushitsu-zuki basurūmu
 100
 yambasu 274
 yamisōru 35
 yampasu 168
 yampingu kā 266
 yampingu torērā 266
 yampu 266
 yampu beddo 266
 yampu suru 266
 yampufaiyā 266
 yampujō 266
 yappu 21
 yarameru 113
 yarawei shido 131
 yaria 204
 yarikotto 75
 yaserōru nabe 69
 yatatsu 82
 yatchā 229
 kyō 306
 kyōdai 22
 kyōfū 286
 kyōgi 243, 247
 kyōgijō 223
 kyōkai 299, 300
 kyōkaku 17
 kyōkasho 163
 kyōkin 16
 kyōkotsu 17
 kyokuchi 282
 kyokusen 165
 kyori 310
 kyōrikiko 139
 kyōshi 190
 kyōshitsu 162
 kyōsō 234
 kyōsōba 243
 kyōtsui 17
 kyū 164
 kyū banme 309
 kyūba 314
 kusa 87
 kyūba ribure 151
 kyūhyaku 308
 kyūin kappu 81
 kyūji suru 64
 kyūji-yō supūn 68
 kyūjō 228
 kyūjō-in 239
 kyūjū 308
 kyūjū banme 309
 kyūka 212
 kyūkei jikan 254
 kyūki sōchi 199
 kyūkon shokubutsu 86
 kyūkyū iryō tai'in 94
 kyūkyū sosei 47
 kyūkyūbako 47
 kyūkyūsha 94
 kyūmei bōto 240
 kyūmei bui 240
 kyūmei dōi 240
 kyūmeitei 214
 kyūnyūki 44, 109
 kyūri 125
 kyūryō 175, 284
 kyūryū 241, 284
 kyūseki 261
 kyūshi 50
 kyūshi torei 172
 kyūshifu 256
 kyūsui-kō 61
 kyūsuiikan 61
 kyūyūjō 199
M
 mabuta 51
 machiai-shitsu 45
 machibari 276
 machikado 298
 madagasukaru 317
 made 320
 made ni 320
 mado 58, 186, 197, 210
 madoguchi 96, 98
 madorā 150
 mafin 140
 mafin-gata 69
 mafurā 31, 203, 204
 māgarin 137
 mago 23

- mago musuko 22
 mago musume 22
 magu kappu 65
 maguma 283
 magumadamari 283
 maguneshiumu 109
 maguro 120
 magusa 186
 mahöbin 267
 maiku 179, 258
 maikuro basu 197
 maikuroraito 211
 mainasu 60, 165
 mairu 310
 maishü 307
 maitä bokkusu 81
 maitoshi 307
 maitzuki 307
 majipan 141
 majoramu 133
 makademianattsu 129
 makedonia 316
 makeru 273
 makijaku 80
 makimodoshi 269
 maku 67, 254
 mäku suru 227
 makura 70
 makurakabä 71
 makurame 277
 mama chichi 23
 mama haha 23
 mama musuko 23
 mama musume 23
 mämarëdo 134, 156
 mamerui 130, 131
 mampuku 64
 manabu 163
 manaita 68
 manchego chizu 142
 manëjã 24, 174
 manga-bon 112
 mangetsu 280
 mangö 128
 manhöru 299
 manikyua 41
 manriki 78
 manshon 59, 298
 manshon-tö 59
 mantoru 282
 mantorupisu 63
 manyuaru 200
 marakasu 257
 marason 234
 marawi 317
 mare ni 320
 marëshia 318
 mari 317
 marina 217
 marine 143, 159
 maruchi bitamin 109
 marugoto 129, 132
 marui kogata pan 140
 marukubi 33
 marumero 128
 marunoko 78
 maruta 316
- maruyane 300
 mashin-gan 189
 mashita 320
 mashumaro 113
 massäji 54
 masshurümu 125
 massugu 260
 masu 120
 masui-shi 48
 masukara 40
 masukingu tëpu 83
 masuku 189, 228, 239, 249
 masume 272
 masutädo 155
 masuto 240
 matchi 112, 230
 mategai 121
 matenö 299, 300
 matïni 151
 mato 249
 matsu 296
 matsu no mi 129
 matsuge 14, 51
 matsuri 27
 matto 54, 235, 267
 mattoreso 70, 74
 maue 320
 maunten baiku 206
 mausu 176
 mausu pisu 237
 mausu wosshu 72
 mayonaka 305
 mayonëzu 135
 mayu 295
 mayuge 14, 51
 mazeru 67, 138
 me 14, 51
 medama kurippu 173
 medamayaki 157
 medaru 235
 megane 51
 megane-ten 51
 megane-ya 189
 mei 23
 meiösei 280
 meirei 180
 meisho 261
 meisö 54
 mejã 276
 mejã kappu 150
 mekjãiki 120, 294
 mekishiko 314
 mekyabetsu 123
 mëkyappu 40
 memo 175, 191
 memori 176
 memori kãdo 271
 men 158, 164, 236, 277
 menka 184
 menkai jikan 48
 menö 289
 menseki 165, 310
 menyü 148, 153, 154
 menyübã 177
 menzeiten 213
 mëpuru shiroppu 134
 merange 140
- merodï 259
 meron 127
 mëru adoresu 177
 mëru akaunto 177
 messëji 100
 messhu kãten 63
 mesu 167
 mësu 132
 meuru 310
 meushi 185
 mezamashi o kakeru 71
 mezamashi-dokei 70
 mezameru 71
 mi 122, 296
 michi annai 323
 michita 321
 midori 274
 midori oribu 143
 migaku 77
 migi 260
 migi desu 323
 migi handoru 201
 mijikai 32
 mijukujji 52
 mikazuki 280
 mikessai-bako 172
 miki 296
 mikisã 66
 mikishingu böru 66, 69
 mikkusu sarada 158
 mimi 14, 139
 mimizu 295
 minami 312
 minami afurika 317
 minami hankyü 283
 minami kaikisen 283
 minato 217
 mineraru wötã 144
 mini disuku reködã 268
 minibã 101
 minikui 321
 minto ti 149
 mippü bin 135
 miriguramu 310
 mirimëtoru 310
 miririttoru 311
 miruku 136
 miruku chokorëto 113
 miruku köhi 148
 miruku ti 149
 mirukusëki 137, 149
 misairu 211
 mishin 276
 mitöbörü 158
 miton 30
 mitopai 158
 mitsuami 39
 mitsubachi 295
 mitto 228
 mitto 236
 miyagemono 260
 mizambiku 317
 mizore 286
 mizu 144, 238
 mizu jetto 95
 mizu o hiku 183
 mizu o yaru 90
- mizu'umi 285
 mizuabi püru 263
 mizubukure 46
 mizugi 238, 265
 mizuhane böshi-ban 66
 mizukiri zaru 68
 mizukiridai 67
 mizukusa 86
 mizumizushi 127
 mizusashi 65, 151
 mizuyari 89
 möbiru 74
 mochikaeri 154
 möchö 18
 modemu 176
 moderu 169
 möfu 71, 74
 mokei 190
 mokei seisaku 275
 mokkan gakkï 257
 mokkö 275
 mokkö-yö doriru bitto 80
 mokkö-yö setchakuzai 78
 mökon 39
 mokusei 280
 mokusei supün 68
 mokutan 275
 mokutekichi 213
 mokuyöbi 306
 mokuzai 79, 275
 mokuzai chakushokuzai 79
 mömaku 51
 momo 126, 128
 momoniku 119
 mon 85, 182
 monako 316
 mondai 271
 mongöika 121
 mongoru 318
 monitã 53, 172, 176
 monohoshi-yö röpu 76
 monoporï 272
 monorëru 208
 monsun 287
 montãju shashin 181
 montenegro 316
 moppu 77
 mörishasu 317
 möritania 317
 morokko 317
 morudibu 318
 mörudingu 63
 morudoba 316
 morutaru 187
 moruto su 135
 moshimoshi 322
 möshitate 94
 mosuku 300
 mötä 88
 motokurosu 249
 motsarera chizu 142
 motto warui 321
 moya 287
 moyashi 122
 moyö sentaku 276
 mu-shhibö 137
 muchiuchishö 46
- muen 137, 199
 mujitsu 181
 mukade 295
 mukiebi 120
 muko 22
 mukötaku 271
 munabire 294
 mune 12
 muneniku 119
 münsutön 288
 mura 299
 murasaki 274
 murasaki igai 295
 mure 183
 mürugai 121
 musekitsuï döbutsu 295
 musen-yö antena 214
 mushi-sasare 46
 mushiba 50
 mushita 159
 mushiyoke 108, 267
 musu 67
 müsu 141
 musuko 22
 musume 22
 muzai 181
 muzukashi 321
 myakuhaku 47
 myüjïkaru 255
- N**
 nadare 247
 nae 91
 nafuda 189
 nagagutsu 31
 nagai 32
 nagasa 165, 310
 nagashi 66
 nagashidai 61, 72
 nage 237
 nageru 221, 227, 229, 245
 naibumpi kei 19
 naibumpi-ka 49
 naifu 65
 naijeria 317
 naikaku 282
 nairon 277
 naisö 200
 naisö köji 82
 naisö köji shokunin 82
 naito 272
 naitogaun 31, 32, 35
 naiya 228
 naizö 18, 118
 naizö furasshu 270
 naka 320
 nakaniwa 58, 84
 nakayubi 15
 naku 25
 nama 124, 129
 nama chizu 136
 nama kuriimu 137
 namaniku 142
 nambã purëto 198
 nambei 315
 namekujji 295
 nami 241, 264

namiashi 243
 namibia 317
 namida 51
 namigata 139
 nan 139
 nan'yō 313
 nana 308
 nana banme 309
 nanahyaku 308
 nanajū 308
 nanajū banme 309
 nankō 47, 109
 nankotsu 17
 nanzai 79
 napukin 65, 152
 napukin ringu 65
 nashi de 320
 nasu 125
 natane 184
 natane abura 135
 natauri 124
 natsu 31, 307
 natsume 129
 natsumeggu 132
 natto 80
 nattsu 129, 151
 nawatobi 251
 naya 85
 naya 182
 ne 50, 124, 296
 nebukuro 267
 nedan 152
 nega 271
 negurije 31, 35
 neji 80
 nekku 258
 nekkurain 34
 nekkuresu 36
 neko 290
 nekutai 32
 nekutaipin 36
 nekutarin 126
 nemaki 31
 nembangan 288
 nendo 85, 275
 nenryō tanku 104
 nenryōkei 201
 nenryōtanku 203
 nenza 46
 neōi suru 91
 nepāru 318
 neru 71
 netsu 44
 netsuken 286
 netsukikyū 211
 nettai 283
 nettai kajitsu 129
 netto 222, 227, 231
 nettowāku 176
 nezumi 290
 ni 308
 ni banme 309
 ni mukatte 320
 ni sotte 320
 ni-ji 304
 nichibotsu 305
 nichiyōbi 306

nīdorū penchi 80
 nīdorupointo 277
 nigai 124
 nigatsu 306
 nihon 318
 nihyaku 308
 nijēru 317
 nijī 287
 nijimasu 120
 nijū 308
 nijū banme 309
 nijūichi 308
 nijūichi banme 309
 nijūni 308
 nijūni banme 309
 nijuppun 304
 nijūsan banme 309
 nikai 104
 nikai seki 254
 nikaidate basu 196
 nikaragua 314
 nikkeru 289
 nikkōyoku o suru 264
 nikomu 67
 nikonda 159
 niku 107, 118
 niku fukku 118
 nikukiribōchō 68
 nikutataki 68
 nikuya 114, 118, 188
 niman 309
 nimotsu 100, 198, 213
 nimotsu hikiwatashi 213
 nimotsuure 210
 nin 129
 ninensō 86
 ningen kankei 24
 ningyō 75
 ninjin 124
 ninniku 125, 132
 ninshin 52
 ninshin dekiru 20
 ninshin shiteiru 52
 ninshin suru 20
 ninshin tesuto 52
 niranegi 125
 nire 296
 nisen nen 307
 nishi 312
 nishi sahara 317
 nishoku-tsuki 101
 nishūkan 307
 nisu 79, 83
 nitchū 305
 nitōkin 16
 niwa 84
 niwa no akusento 84
 niwa no shokubutsu 86
 niwa no yōshiki 84
 niwashi 188
 niwatori 185
 no aida 320
 no jōhō 320
 no kahō 320
 no mae 320
 no mukaigawa 320
 no mukō 320

no naka e 320
 no soba 320
 no ue 320
 no ue e 320
 no ushiro 320
 nobasu 251
 nochi 304
 nōchi 182
 nochihodo 320
 nodo 19
 nodo ame 109
 nodobotoke 19
 nōfu 182, 189
 nōjō 182
 nōka 182
 nōka no niwa 182
 noki 58
 nokku auto 237
 nokogiri-ba 78
 nomi 81
 nomimono 107, 144, 156
 nori 275
 nori-zuke dai 82
 noribake 82
 norikaeru 209
 norikumi'in 241
 noritsugi 212
 noruwē 316
 noshibō 69
 nōshintō 46
 nōsotchū 44
 nōsurību 34
 nōto 163, 172, 173
 nōto o toru 163
 nōtopasokon 175, 176
 nozuru 89
 nu'u 277
 nugā 113
 nuigurumi 75
 nuime 34, 277
 nunoji 277
 nyō kan 21
 nyōdō 20
 nyūbachi 167
 nyūbō 167
 nyūeki 41
 nyūgaku jimukyoku 168
 nyūgaku suru 26
 nyūin 48
 nyūji 23
 nyūjirando 319
 nyūjō muryō 322
 nyūjō-ryō 260
 nyūkin suru 96
 nyūkin-sho 96
 nyūkoku shinsa 213
 nyūseiin 107, 136
 nyūsu 178
 nyūsukyasutā 179, 191
 nyūtō 137
 nyūtoraru zōn 224

○
 o 121, 242, 280, 290, 292, 294
 o mawatte 320
 o tōtte 320
 o yokogitte 320

o-susume ryōri 152
 o-tearai 104
 o-tsumami 151
 o-ushi 185
 oba 22
 ōbā pā 233
 ōbāfurō kan 61
 ōbāheddo purojekutā 163
 ōbāōru 30
 obi 236
 obikiyoseru 245
 ōboe 257
 oboreru 239
 ōbun 66
 ōbunmitto 69
 ōdan hodō 195
 odango 39
 ōdio shisutemu 268
 odomētā 201
 ōdōri 299
 odoriba 59
 odoroku 25
 ōdotoware 41
 ofisu 24
 ofisu biru 298
 ofu saido 223
 ōfuku bunri dōro 195
 ōhanmā 187
 ohayō gozaimasu 322
 ohyō no kirimi 120
 oi 23
 oikoshi shasen 194
 oikosu 195
 oiru 199
 oiru gēji 202
 oiru tanku 204
 oita 321
 oiwai 27, 140
 oiwai-yō kēki 141
 oji 22
 ōkakumaku 19
 ōkami 290
 okan 44
 ōkē 322
 ōkesutora 254, 256
 ōkesutora pitto 254
 ōki 321
 okiru 71
 okoru 25
 okosama menyū 153
 okujō teien 84
 okura 122
 okure 209
 okuyuki 165
 ōkyū teate 47
 omān 318
 omaru 74
 omocha 75, 105
 omocha kago 75
 omoi 321
 omori 166, 244
 omoshiroi 321
 ompu 256
 ōmu 293
 ōmugi 130, 184
 omuretsu 158
 omutsu 30, 75

omutsu kabā 30
 omutsu kabure kurīmu 74
 omutsu kae baggu 75
 omutsu kae shīto 74
 ondokei 167
 ondori 185
 ongaku 162
 ongaku gakkō 169
 ongaku janru 259
 ongakuka 191
 ongakukai 255
 onigiri 154
 ōningu 148
 onkai 256
 onna no ko 23
 onrain 177
 onryō 179, 269
 onsei messeji 99
 onshitsu 85
 onsu 310
 onsuī tanku 61
 onsuī tappu 72
 opāru 288
 opera 255
 ōpun kā 199
 ōpun toppu 260
 ōpun-sando 155
 oranda 316
 oregano 133
 orenji 126
 orenji iro 274
 orenji jūsu 149
 orenjiēdo 144
 orību 151
 orībuyu 134
 origami 275
 orimage genkin 98
 ōrora 286
 oroshigane 68
 oroshita 121
 ōru 241
 ōrusupaisu 132
 orutanēta 203
 osae 237, 276
 osage 39
 oshibe 297
 oshikomi gōtō 94
 oshiri fuki 74
 oshiroi 40
 osoi 305, 320
 osu 322
 ōsutorarēshia 319
 ōsutoraria 319
 ōsutoria 316
 otafukukaze 44
 otama 68
 otamajakushi 294
 ōtobai 204
 ōtobai rēsu 249
 otoko no ko 23
 ōtoma 200
 otona 23
 ototoi 307
 otsuri 99
 otto 22
 otto 221
 owari 32
 ōya 58

oyasuminasai 322
oyayubi 15
oyogu 238
oyoso 320
özara 65
ozonsö 286

P

pä 233
paddo 53, 220
padokku 243
padoru 241
pafu 40
pāgora 84
pai 143
pai kiji 140
pai yaki-zara 69
painappuru 128
painappuru jūsu 149
painto 311
paipu 112
paipu kattä 81
pairotto 190, 211
pajama 33
pākingu mētä 195
pakisutan 318
pakku 224, 311
pāma 39
pan 138, 157
pan kiji 138
pan rui 107
pan shokunin 139
pan-zukuri 138
pan'ya 114, 138
panama 314
panchi baggu 237
panda 291
pankēki 157
panko 139
panku 203, 207, 259
panku shūri setto 207
pansuto 34, 35
panti 35
panti rainä 108
papaia 128
papuanyūginia 319
papurika 132
paraguai 315
paraguraidingu 248
parashūto 248
parashūto kōka 248
parasoru 148
paretto 186, 274
parittoshita 127
parumetto yashi no shin 122
parumezan chīzu 142
paseri 133
pasokon 172
pāsonaru torēnā 250
passhonfurūtsu 128
pasu 226
pasu suru 220, 221
pāsunippu 125
pasuta 158
pasuteru 274
patä 233
patchi 207

patchiwāku 277
pate 142, 156
patokä 94
patto o utsu 233
pauä 132
pedaru 61, 206
pedikyua 41
pedimento 301
pegu 258, 266
pemparu 24
pen 163
penaruti 223
penaruti eria 223
penchi 80
pendanto 36
pengin 292
penisu 21
penki 83
pensaki 163
pēpā napukin 154
peparoni 142
perikan 292
perü 315
pessari 21
pesutori 140, 149
petto fūdo 107
petto shoppu 115
piano 256
pikannattsu 129
pikkoro 257
pikkuappu 258
pikkunmikkusu 113
pikunikku 263
pikunikku bencheshi 266
pikurusu 159
pīman 124
pimboka 271
pin 60, 249
pinattsu 129, 151
pinattsubatä 135
pinku 274
pinsetto 47, 167
pinto o awaseru 271
pipetto 167
piratisu 251
piru 21
pisutachio 129
pita pan 139
pitchä 229
pitchä maundo 228
pitchi 225, 256
piza 154, 155
piza-ya 154
pōchi 58
pökä 273
poketto 32
pön 272
pondo 310
poniteru 39
poppukön 255
poppusu 259
popura 296
popuri 111
pōrando 316
poriesuteru 277
porijiji 157
poro 243

pōru 266
porutogaru 316
posutä 255
posutä karä 274
pötä 100
pötäburu shi-dī purēyā 268
poteto chippusu 113, 151
poteto masshā 68
pōto 176
pōtoforio 97
pōtorēto 271
pōtowain 145
puchi tomato 124
pudingu raisu 130
puerutoriko 314
purachina 289
puragu 60
puraimä 83
puramu 126
purasu 60, 165
purasu doraibā 80
purattofōmu shūzu 37
purē no sen 233
purēto 283
purēyā 268, 273
purezentä 174
purezenteshon 174
purezento 27
purin 141
purinta 172, 176
purodyūsä 254
puroguramu 176, 254
purojekutä 174
puropera 211, 214
purosessa 176
puroshutto 143
pūru 101, 238, 249, 250

R

raberu 89, 172
rabu 230
radisshu 124
rafu 232
rafutingu 241
ragubī 221
ragubī bōru 221
ragubī senshu 221
ragubī-gi 221
ragubī-jō 221
raibu 178
raimame 122, 131
raimu 126
raimugi pan 138
rain jajji 220
raion 291
raishū 307
raisu pudingu 140
raitä 112
raito 207
raito suitchi 201
rajijētä 60, 202
rajio 179, 268
rajio kyoku 179
rajio o tsukeru 269
raketto 230, 231
raketto supōtsu 231
rakettoobōru 231

rakkasei yu 135
raku 221
rakuda 291
rakunōjō 183
rakurossu 249
rakuyōju 86
ramadān 27
ramikin 69
rampaku 137
rampu 62, 217
rampusutēki 119
ramu 176
ramu niku 118
ramushu 145
ran 111, 228
ran'ō 137
ranchon matto 64
randosukēpu 271
ranhō 20
ranjeri 35, 105
ranji 251
rankan 20
ranningu shatsu 251
ranshi 20, 51
ransō 20
raosu 318
raperu 32
rappu 259
rappu-sando 155
rari 230, 249
ratobia 316
raudo supikä 268
raundo 237
razuberi 127
razuberi jamu 134
rebä 61, 118, 150
rebä'āchi-shiki fairu 173
rebanon 318
rēdä 214, 281
reddo kādo 223
reddokaranto 127
rege'e 259
reggu paddo 225
reggu puresu 251
reginsu 31
regyurētä 239
rei 308
rei ten go rittoru 311
reijō 180
reiki ryōhō 55
reikyakueki tanku 202
reinkōto 31, 32
reishi 128
reisui tappu 72
reitō 121, 124
reitō shokuhin 107
reitō suru 67
reitōko 67
reitōreizōko 67
reizōko 67
reji 106, 150
rejji-gakari 106
rēki 88
rekigan 288
rekishi 162
rekishi-teki kenzōbutsu 261
rekkä idō 195

rekōdo-ten 115
remon 126
remon garei 120
remon kādo 134
remon ti 149
remonēdo 144
remongurasu 133
rēn 234, 238
ren'ai monogatari 255
ren'ai suru 26
renchi 81, 203
renga 187
renmei 223
rennyū 136
renshū-jiai 237
rentakä 213
rentogen 48
rentogen byuā 45
rentogen kensa sōchi 212
rentogen shashin 50
renzoku dorama 178
renzu 51, 270
renzu kēsu 51
renzu kyappu 270
renzumame 131
repötä 179
rēru 208
rēsä 249
reshibu suru 227
rēshingu baiku 205
resoto 317
ressha 208
restoran 101
rēsu 35
rēsū-yō bobin 277
rēsuaumi 277
resuringu 236
resutoran 152
retäheddo 173
retasu 123
retsu 210, 254
retto 230
ribaundo 226
riberia 317
ribia 317
ribon 27, 39, 111, 141, 235
rīdo shingä 258
rifu ti 144
rifurekusorojō 54
rifurekutä 204, 207
rifuretto 96
rifuto 246
rigakuryōhō-ka 49
rigin 240
rihitenshutain 316
rikon 26
riku-game 293
rikuchi 282
rikujō kyōgi 234
rikujō kyōgi-sha 234
rikyūru 145
rimä 80
rimokon 269
rimpa kei 19
rimu 206
rimujin 199
rinchi 285

rinden 296
rinen 277
ringo 126
ringo jūsu 149
ringo no shin nuki-ki 68
ringo su 135
ringoshu 145
ringu 237
ringu tai 89
rinjin 24
rinku 36
rippōtai 164
rippu burashi 40
rippu gurosu 40
rippu rainā 40
rirakusēshon 55
rirē kyōsō 235
ririku suru 211
riru 244
risaikuru bokkusu 61
risu 290
risutobando 230
ritān 231
ritoania 316
rittaizukei 164
rittoru 311
roba 185
rōbai suru 25
robī 100, 255
robu 231
rōbu 169
robustā 121, 295
rodeo 243
rōdo baiku 206
rōdo rēsā 206
rōganberi 127
rogo 31
roguon suru 177
rōingu mashin 250
roji 298
rojō kafe 148
rokata 194
roketto sarada 123
rokkā 239
rokkaku-bō renchi 80
rokkakukei 164
rokkankin 16
rokkī sanmyaku 312
rokkotsu 17
rokku 207
rokku konsāto 258
rokku kuraimingu 248
rokoko 301
roku 308
roku banme 309
rokuga 178, 269
rokugatsu 306
rokujū 308
rokujū banme 309
rokuon sutajio 179
rokuro 275
romen densha 196, 208
romen hyōshiki 194
rompāsu 30
rōn 96
roppyaku 308
rōpu 248, 266

rōrā 83, 187
rōrā ukezara 83
rōrāburēdo 263
rōrāsukēto 249
rōrāsukēto-gutsu 249
rōrie 133
rōru 311
rōru sukurin 63
rōrupan 139, 143
rosen bangō 196
roshi 167
roshia rempō 318
roshutsu 271
roshutsu hōsei daiyaru 270
roshutsu-busoku 271
roshutsu-ōbā 271
roshutsukei 270
rōsoku 63
rōsuto 158
rōsuto suru 67
rōtā burēdo 211
roten 154
rōto 166
roze (wain) 145
rōzumari 133
ruā 244
rubī 288
rūfu rakuu 198
rūku 272
rukusemiburuku 316
rūmania 316
rūmu sābisu 101
runesansu 301
rūpin 297
rusuban denwa 99
rūtā 78
rutabaga 125
rutsubo 166
ruwanda 317
ryōchō 119
ryōdo 315
ryōgaejo 97
ryōhōshi 55
ryoken 213
ryōkin 197, 209
ryōkin-jo 194
ryokō dairiten 114, 190
ryokō kogitte 97
ryokō panfuretto 212
ryokōkaban 37
ryokucha 149
ryokutō 131
ryōseirui 294
ryōshi 189
ryōshin 23
ryōshūsho 152
ryūchijō 94
ryūju 247
ryūkusakku 31, 37, 267
ryūsei 280
ryūzan 52

S

saba 120
sābā 176
sabaku 285
sābisu purobaida 177

sābisu-ryō 152
saboten 87
sābu 231
sābu rain 230
sābu suru 231
sadoru 206
sāfā 241
safaia 288
safari pāku 262
sāfin 241
sāfubōdo 241
safuran 132
sagan 288
sagefuri 82
sagyō-sha 212
sagyōba 78
sagyōdai 78
sahara sabaku 313
sai 291
saibai suru 91
saibankan 180
saibansho shokuin 180
saido dekki 240
saido ōdā 153
saidorain 220, 226, 230
saien 182
saifu 37
saigo 320
saihō-bako 276
saihosō 187
saijōdan 141
saikoro 272
saikuringu 263
saimin ryōhō 55
sairen 94
sairo 183
saizei 269
saisho 320
saito 266
sakago 52
sakana 107, 120
sakana no kunsei 143
sakanaya 114, 120, 188
sakaya 115
sake 120, 152
sakitto torēningu 251
sakkā 222
sakkā bōru 222
sakkā senshu 222
sakkā shūzu 223
sakkā-gi 31, 222
sakkā-jō 222
sakkin 47
sakotsu 17
saku 74, 85
sakubun 163
sakugu 215
sakumotsu 183, 184
sakunyū-ki 53
sakurambo 126
sakurasō 297
sakusofon 257
sambashi 217
sambeddo 41
sambyaku 308
same 294
sāmosutatto 61

samui 286
san 23, 308
san banme 309
sandā 78
sanderu 31, 37
sandoitchi 155
sandoitchi uriba 143
sandopēpā 83
sangai 104
sangai seki 254
sangatsu 306
sangoshō 285
sangurasu 51, 265
sanhanki 52
sanjū 308
sanjū banme 309
sanjuppun 304
sanka 49
sanka byōtō 48
sanka-i 52
sankakkei 164
sankaku-kōn 187
sankakufu 46
sankakujōgi 165
sankakukin 16
sankō shiryō 302
sankyaku 166, 270, 281
sanmarino 316
sanmyaku 282
sanrūfu 202
sanruishu 228
sanshō-uo 294
sanshoku-tsuki 101
sansu 165
sansukurin 108
santōkin 16
santome purinshipe 317
sao 245
sapōtā 227
sapurimento 55
sara 65
sara'arai-ki 66
sarada 149
sarada doreshshingu 158
sarada yu 135
sarami 142
sāroinsutēki 119
saru 291
sarudinia 316
sarutana rēzun 129
sasaeobō 89, 91
sashidashinin jūsho 98
sashimi 121
sasori 295
sasu 90
sasupenshon 203, 205
satchūzai 89, 183
satōkibi 184
satōzuke kudamono 129
satsuire 37
satsuma mikan 126
satsumaimo 125
saujiarabia 318
sauna 250
saundo enjinia 179
saundotorakku 255
sawā kurimu 137

sawādō bureddo 139
saya 122
sayoku 228
sayōnara 322
se no hikui 321
se no takai 321
sebiire 294
sebone 17
sēbu suru 223
sedai 23
sedan 199
sēfu 228
sei kansenshō 20
seibi kojō 199
seibugeki 255
seibutsu 162
seichō dankai 23
seifuku 94, 189
seigen sokudo 195
seihatsu suru 39
seihyōshitsu 67
seijigaku 169
seikatai seki 301
seikei dōgu 275
seikei-geka 49
seiki 12, 307
seikō 20
seikotsu ryōhō 54
seikyoku 167
seinō 21
seiri yōhin 108
seiri-yō napukin 108
seiseki 163
seishi 20
seishi suru 91
seishin-ka 49
seishoku 20
seishokuki 20
seishokuki kei 19
seisō 21
seisōken 286
seitai 19
seiten 286
seito 162
seiuchi 290
seiun 280
seiyōwasabi 125
seiyu 55
seiza 281
sēji 133
sekai chizu 312
seki 44
sekidō 283
sekidō ginia 317
sekidome 108
sekieie 289
sekika 126
sekitan 288
sekitei 84
sekiyu tankā 215
sekizai 275
sekizai-yō doriru bitto 80
sekkai-shitsu dojō 85
sekkaihan 288
sekken 73
sekken-zara 73
sekyuriti bitto 80

- sembankō suru 79
sembi 240
semento 186
semidetatchi 58
semihādo chīzu 136
semisofuto chīzu 136
semorina 130
semotare 64, 210
sempatsu 39
sempūki 60
sen 19, 72, 165, 309
sen kyūhaku ichi nen 307
sen kyūhaku jū nen 307
sen kyūhaku nen 307
sen'i 127
sen'in 189
senaka 13
senaka arai burashi 73
senaka no kubomi 13
senbikampan 214
senchimētōru 310
senchō 214
senegarū 317
sengaiki 215
senjō eki 51
senkan 215
senkyaku 216
senkyaku-kō 216
senkyō 214
senmon'i 49
senmongakkō 169
sennenkan 307
sennuki 68, 150
senrei 26
senro 209
sensei 54, 162
sensha 199
senshin 230
senshitsu 214
senshu 214, 240, 307
senshūken 230
sensō 215
sensuikan 215
sentā 228
sentā sākuru 222, 224, 226
sentābōdo 241
sentai 214, 240
sentakki 76
sentaku 76
sentaku kansōki 76
sentaku sabisu 101
sentaku-basami 76
sentakukago 76
sentakumono 76
sentakumono ire 76
sentan 36, 122
sentārain 226
sentei noko 89
sentei suru 91
sentei-basami 89
sentō 300
sentobinsento oyobi gurenadin
 shotō 314
sentōki 211
sentokurisutofā nēvisu 314
sentorushia 314
senzai 77
- seoyogi 239
seramikku konro 66
sēringu 240
serori 122
seroriakku 124
serotēpu 173
sēru 241
serubia 316
serufu tanningu kurīmu 41
sesshi 50
setā 33
setchi pin 60
setsugan renzu 167
setsuzoku suru 177
setto 178, 230, 254
setto suru 38
shaberu 265
shābetto 141
shachō 175
shadamben 61
shahen 164
shakkotsu 17
shako 58
shakuyanin 58
shamen 284
shampan 145
shampū 38
shampū dai 38
shāpu 256
shārē 166
sharin 198
sharin-tsuki tanka 48
shasei kan 21
shashi 203
shashin 270, 271
shashin hantei 234
shashin satsuei 271
shashin-yō gakubuchi 271
shashinka 191
shasō 209
shatai 202
shatoru 231
shatoru basu 197
shattā 270
shattā sokudo tsumami 370
shawā 72
shawā doa 72
shawā jeru 73
shawā kâten 72
shawā o abiru 72
shawā tō 266
shawāheddo 72
shefu 152, 190
shefu no bōshi 190
shēkā 150
sherī 145
shī-dī purēyā 268
shi 308
shiai 237
shiatsu 54
shiatsu ryōhō 55
shiba de ōu 90
shibafu 85, 90, 262
shibakarī suru 90
shibakariki 88, 90
shiberia 313
shibori bukuro 69
- shichaku shitsu 104
shichi 308
shichigatsu 306
shichijū 308
shichimenchō 119, 185, 293
shichiria 316
shichōsha 299
shichū 158
shida 86
shierareone 317
shifuto rebā 207
shigai 298
shigaisen 286
shigatsu 306
shigoto 170
shihari 96
shiharau 153
shihēi 97
shijōkaijatsū bu 175
shijū 308
shika 291
shika kenshin 50
shika niku 118
shika rentogen 50
shika yunitto 50
shikai-sha 178
shikakkei 164
shikame-zura 25
shikan 50
shiken 163
shikenkan 166
shikenkan-tate 166
shiki dai 256
shiki'ishi 85
shikibetsu bando 53
shikibō 256
shikiri kado 173
shikisha 256
shikke no ōi 286
shikkui 83
shikkui o nuru 82
shikō 50
shikyū 20, 52
shikyū keibu kakuchō 52
shikyūkei 20
shima 282
shima hōzuki 128
shimai 22
shimamenō 289
shimatta 321
shimauma 291
shimbaru 257
shimbun 112, 178
shimbun hambaiten 112
shimetta 321
shimo 287
shimon 94
shimpai suru 25
shimpan 222, 226, 227, 229, 230
shin 122, 127, 173
shin kyabetsu 123
shin'yōju 86
shinagōgu 300
shinai 236
shinamon 133
shinchō-kei 45
shindai shokitsū 209
- shindo 91
shingapōru 318
shingetsu 280
shingō 194, 209
shingu 74
shingu taoru rui 105
shinguru 151
shinguru beddo 71
shinguru kurīmu 137
shinguru rūmu 100
shingurusu 230
shinjaga 124
shinju no kubikazari 36
shinkai-zuri 245
shinkansen 209
shinkei 19, 50
shinkei kei 19
shinkei-ka 49
shinkotenshugi 301
shinkū kappu 53
shinkuronaizudo suimingu 239
shinnyū kinshi 195, 323
shinri ryōhō 55
shinrin 285
shinrui 23
shinryō-shitsu 45
shinryōjo 48
shinsatsu 45
shinseiji 53
shinsen 121, 127
shinshi fuku 105
shinshitsu 70
shintaiishō 235
shintaiishōgaisha-yō chūsha
 supēsu 195
shinu 26
shinzō 18, 119
shinzōbyō-ka 49
shinzōhossa 44
shio 64, 129, 152
shio-furi 121
shio-iri 137
shioaji 155
shiomizu-zuke 143
shiozuke 143
shirā 83
shirakaba 296
shiretsu kyōsei burijji 50
shiri 13
shiria 318
shiriaru 156
shiriaru shokuhin 107, 130
shirindā heddo 202
shirizu bangumi 178
shiro 145, 272, 274, 300, 321
shiro komugiko 138
shiro pan 139
shiroari 295
shiroari niku 118
shiroppu 109
shiroppu-zuke 159
shirudo 88
shiryō dai 167
shiryoku 51
shiryoku kensa 51
shisha 175
shishinkei 51
- shisho 168, 190
shishū 277
shisō 263
shishin suru 44
shisutemu 176
shisutemu techō 173
shita 19
shita e 320
shitagi 32
shitagoshirae shita tori 119
shitake 124
shitānuri 83
shitateya 115, 191
shitchi 285
shitenchō 96
shīto 204, 241
shīto beruto 198, 211
shīto pirā 206
shītsu 71, 74
shitsugaikotsu 17
shitsumon 163
shitsumon suru 163
shiwa 15
shiwa tori 41
shiyō kigen 109
shiyō-chū 321
shizen ryōhō 55
shizuka na 321
shoberu 88
shōbōsha 95
shōbōshi 95, 189
shōbōsho 95
shōbōtai 95
shōchō 18
shōdoku eki 47, 51
shōdoku waipu 47
shōga 125, 133
shōgai hietsu 243
shōgai kyōsō 243
shōgaibutsu 243
shōgakuhi 169
shōgatsu 27
shōgeki o ukeru 25
shōgo 305
shohōsen 45
shoka 168
shōkai 49
shōkaki 95
shōkaki kei 19
shōkasen 95
shōken torihiki-jo 97
shokkaku 295
shokki 64
shokki rui 65
shokkidana 62
shokku 47
shōko 181
shoku 280
shokubutsu 296
shokudō 19
shokudō-sha 209
shokugyō 188, 190
shokuhin uriba 105
shokujū 64, 75, 158
shokuminchi 315
shokumu 92
shokupan no katamari 139

- shokuryōhin 106
shokuryōhin-ten 114
shokuyō abura 134
shokuzenshu 153
shōkyūshi 50
shomei 96, 98
shōmei 178
shōmei kigu 105
shōmeidan 240
shōmen genkan 58
shōni byōtō 48
shōni-ka 49
shonichi 254
shōnin 180
shoppingu sentā 104
shorudā paddo 35, 224
shorudābaggu 37
shosai 63
shōsetsu 256
shōsha 273
shōten 298
shōten chōsetsu nobu 167
shōtō 300
shōtorihiki 175
shōwakusei 280
shōyu 135
shōzō 260
shū 306, 315
shū-gawa 140
shubi suru 225
shūchū chiryō-shitsu 48
shuhan 240
shūhasū 179
shūho 243
shūjitsu 306
shujutsu 48
shujutsu-shitsu 48
shūka 98
shūkaku suru 91
shukketsu 46
shukkin irai-sho 96
shukkō suru 217
shukudai 163
shukuhaku kyaku 100
shukuhaku-sha meibo 100
shukushō suru 172
shūmatsu 306
shuppatsu bin 213
shuppatsu robī 213
shūrikō 188, 203
shusai 153
shūshi gō 169
shūshoku suru 26
shūsō baggu 88
shus-san 53
shus-san mae 52
shus-san suru 26
shussei shōmeisho 26
shussei-ji taijū 53
shussei suru 174
shussui-kō 61
shutchō 175
shuto 315
shūto suru 223, 227
shutō uchi 237
shutsunyū dōro 216
shutsunyū-ro 194
- shutsunyūkoku kanri 212
sobakasu 15
sobo 22
sōbōkin 16
sobyō 275
sōda pan 139
sōdasui 144
sode 34, 254
sodeguchi 32
sofa 62
sofa beddo 63
sofu 22
sofubo 23
sofuto 176
sofuto chizu 136
sofuto dorinku 144, 154
sōgankyō 281
sōgen 285
sōji 77
sōji dōgu 77
sōji sabisu 101
sōjifu 188
sōjiki 77, 188
sōjū shitsu 210
soketto 80
soketto renchi 80
sokki-sha 181
sōko 216
sōkō shasen 194
sokudokei 201, 204
sokutei 165
sokuten 235
sōkyū suru 223
somnia 317
sonata 256
sonota no mise 114
soramame 122, 313
sori suberi 247
soromon shotō 319
sōsakei 201, 204
sōsēji 118, 155, 157
sōshiki 26
sōshin suru 177
sōshingu 36
soshō anken 180
sosogu 67
sōsu 135, 143, 155
soto 320
sotogawa 320
sotsugyō suru 26
sotsugyō-rombun 169
sotsugyō-shiki 169
sotsugyō-shōsho 169
sotsugyōsei 169
su 135, 142
suberidai 263
suburi 233
suchiru ūru 81
suchuwādesu 190
sūdan 317
suettopantsu 33
sufure 158
sūgaku 162, 164
sūgaku yōhin 165
sugikoshimatsuri 27
suichi ryōhō 55
suichoku-anteiban 210
- suichokusen 165
suichiyoku-sen 215
suidōsui 144
suiiei 238
suiiei senshu 238
suiiei yōhin 238
suiiei-bō 238
suiuin 289
suihei-biyoku 210
suiheiki 187
suijō hikōki 211
suijō supōtsu 241
suijōsuki 241
suijōsuki ita 241
suijōsukiya 241
suika 127
suikazura 297
suikeiki 80
suikomi hōsu 77
suikyū 239
suimin 74
suimin'yaku 109
suimbōdō 238
suingu suru 232
suionkei 201
suisai enogu 274
suisai 280
suiseki 288
suisen 111
suishitsu 61
suishō ryōhō 55
suishōtai 51
suisu 316
suitchi 60
suitō 44, 206, 267
suīto chokorēto 113
suitō-gakari 96
suiyōbi 306
suiyōsei 109
suizō 18
suji 126
sūji 308
sukāfu 36
sukaidaibingu 248
sukasshu 231
sukāto 30, 34
suketchi 235
suketchi bukku 275
sukēto 224
sukēto de suberu 224
sukēto-gutsu 247
sukētōbōdō 249, 263
sukētōbōdō-nori 249
suki 246
suki ita 246
suki-gutsu 246
suki-jō 246
sukimu miruku 136
sukinkea 108
sukiwea 246
sukiya 246
sukoabōdō 225
sukoppu 89, 187
sukoshi 320
sukotchi 151
sukūpu 149
sukuraburu 272
- sukuramburu eggu 157
sukuramu 221
sukurēpā 82
sukurōrubā 177
sukūru basu 196
sukuryū doraibā 151
sukūtā 205
sukuwatto 251
sukyan 48, 52
sukyanā 176
sukyūba daibingu 239
sumasshu 231
sumi 266
sumimasen 322
sumō 237
sumomo 129
sumpō 165
suna 264
suna no shiro 265
sunaba 263
sunakku bā 148
sunappu 30
sunatsuchi 85
sune 12
sunea doramu 257
sunikā 31, 37, 251
sunōbōdō 247
sunōkeru 239
sunōmōbiru 247
sunōsūtsu 30
sunūkā 249
supaiku 233
supāku puragu 203
sūpāmāketto 106
supana 80
supea ribu 155
supea taiya 203
supēdo 273
supein 316
supēsu shatoru 281
supīdo kukku 130
supīdo otose 323
supīdo sukēto 247
supikā 176, 258
supikā sutando 268
supin 230
supoito 109, 167
supōku 207
suponji 73, 74, 83
suponji fingā 141
suponji kēki 140
supōtsu 218
supōtsu firudo 168
supōtsu fisshingu 245
supōtsu jaketto 33
supōtsu jimu 250
supōtsu kā 199
supōtsu yōhin 105
supōtsu-yō burajā 35
supōtsuman 191
supottoraito 259
suppai 127
sūpu 153, 158
supūn 65
supurē 109
supurē kan 311
supureddo 135
- supuringu 71
supuringu onion 125
supurinkurā 89
supuritto pi 131
supuroketto 207
supūru 245, 271
sūpusupūn 65
sūpuzara 65
suraidingu suru 229
suraido 167
suraisā 139
suraisu 139, 230
suraisu shokupan 138
surakkusu 34
surasutā 281
surī doa 200
surī-pointo rain 226
suribachi 68
surikizu 46
surikogi 68
surinamu 315
suriorosu 67
surippa 31
surippon 37
surippu 35
suripūsūtsu 30
surirā 255
suriranka 318
surō-in 223, 226
surobakia 316
surobenia 316
surototoru 204
sushi 121
sūshiki 165
suso 34
supea 76
sutaffudo oribu 143
sutāfurūtsu 128
sutampu 225
sutampo dai 173
sutando 88, 166, 205, 207, 268
sutansu 232
sutātingu burokkū 234
sutāto dai 238
sutāto rain 234
sutemu 112
sutenresu 79
sutenshiru 83
suteppā 250
sutereo 269
sutēshonwagon 199
sutikku 133, 224, 249
sutiru 144
sūto 273
sutokkingu 35
sutokku 246
sutoppā 166
sutoppuwotchi 234
sutoraiiku 228
sutorappu 35, 37
sutorappuresu 34
sutorēnā 68
sutoresu 55
sutoretchi 251
sutorēto 39
sutorēto ni suru 39
sutorō 144, 154

- sutorōku 231, 233
sūtsu 32
suwajirando 317
suwēden 316
suzu 289
suzuki 120
suzume 292
- T**
- ta no kōgei 275
ta no supōtsu 248
tabako 112, 184
tabako hitohako 112
tabemono 116, 149
taberu 64
tābochājā 203
tabun 322
tachiōyogi suru 239
tachashī 321
tagayasu 183
tāgetto shageki 249
tai 120, 318
tai'iku 162
tai'in 48
taiban 52
taiburēku 230
taibutsu renzu 167
taifū 286
taiheiyō 312
taihi 88
taihi-zumi 85
taiho 94
taiji 52
taijō suru 223
taijū-kei 45
taikakusen 164
taikiken 282, 286
taikyokuken 237
taimā 166
taimingu 203
taimu 133
taimu auto 220
tainetsusei 69
taionkei 45
tairiku 282, 315
tairu o haru 82
tairyūken 286
taiseiyō 312
taiseki 165
taisekigan 288
taishoku suru 26
taisō kyōgi 235
taisō senshu 235
taitsu 251
Taiwan 319
taiya 198, 205, 206
taiya kūkiatsu 203
taiya o kōkan suru 203
taiya rebā 207
taiyō 280, 282
taiyōkei 280
tajikisutan 318
takai 321
takarakuji 112
takasa 165
takatobikomi 239
take 86
- takenoko 122
taki 285
takkingu suru 241
takkurū 245
takkurū bokkusu 244
takkurū suru 220, 221, 223
takkyū 231
tako 121, 295
takomētā 201
takuhai 99, 154
takusan 320
takushī no untenshu 190
takushī noriba 213
tamago 137
tamanegi 124
tambaran 257
tamburā 65
tameiki o tsuku 25
tāminaru 212
tamo 244
tampa 179
tampan 33
tampon 108
tampopo 123, 297
tan 118
tana 66, 67, 106
tandemu jitensha 206
tane 88, 122, 127, 128, 130, 131
tane o maku 183
tane o ueru 90
tane-iri pan 139
tanemaki torei 89
tanenashi 127
tanensō 86
tangutsu 37
taniku shokubutsu 87
tanima 284
tanjerin 126
tanjō 52
tanjō pāti 27
tanjōbi 27
tanjōbi kēki 141
tanjōbi kēki no rōsoku 141
tanka 94
tanku 239
tankyori sōsha 234
tanryū 130
tanshin 50, 304
tansu 70
tansui-zuri 245
tanuki 290
tanzania 317
taoru 73
taorukake 72
tappu 150
tara 120
taragon 133
taroiimo 124
tarukamu paudā 73
taruki 186
tārumakku 187
taruto-gata 69
tasu 165
tasumania 319
tatchi rain 221
tatchiauto suru 229
tatchidaun 220
- tategami 242, 291
tatemono 299
tatemono to kōzō 300
tateru 186
tatsu-no-otoshigo 294
taunhausu 58
tawara 184
tazuna 242
te 13, 15, 273
teate 47
tebaniku 119
tebiki noko 81
tebukuro 36
tēburu 64, 148, 210
tēburu settingu 65, 152
tēburukurosu 64
techō 175
tedibea 75
tefuron kakō 69
tegami 98
tei-shigeki sei 41
teian sho 174
teiden 60
teien 261
teiki kankōbutsu 168
teiki-ryokakki 210, 212
teimen 164
teio sekkai 52
teionsakkin 137
teionsakkin shiteinai 137
teire suru 91
teisha botan 197
teisha kinshi 195
teishi 269
teishibō niku 118
teishibō-nyū 136
teitetsu 242
tejō 94
tekira 145
tekondō 236
tekubi 13, 15
tekunikku 79
tēma paku 262
tembin 166
tembōtō 215
tempu shorui 177
tempuku suru 241
ten 273
ten'in 104, 188
tenimotsu 211, 213
tenisu 230
tenisu kōto 230
tenisu senshu 231
tenisu-gutsu 231
tenji-hin 261
tenjō 62
tenkan 44
tenmongaku 281
tennai inshoku 154
tennen sen'i 31
tennōsei 280
tenohira 15
tenrankai 261
tentaiböenkyō 281
tenteki 53
tento 267
tento o haru 266
- tentōmushi 295
teoshi kato 233
tēpu kattā 173
tērādō 35
terasu 58
terasu gāden 84
terasu kafe 148
terebi gēmu 269
terebi o kesu 269
terebi o miru 269
terebi o tsukeru 269
terebi sutajio 178
terepin-yu 83
teroppu 179
tēru raito 207
tēru rampu 204
tesuri 59, 196
tesūryō 97
tetsu 289
tetsubō 235
tetsubun 109
tetsudō-mō 209
tetsugaku 169
tī 233
tī baggu 144
tī guraundo 232
tīkappu 65
tīn'ējā 23
tīpotto 65
tīshatsu 30, 33
tīshotto o uchidasu 233
tīsshu 108
tīsshu no hako 70
tīsupūn 65
tō 300
to issho ni 320
tō kurippu 207
tō sutorappu 207
to'on kigō 256
tobi-geri 237
tobi-ita 238
tobikomi 239
tobikomi senshu 238
tobikomi sutāto 239
tobikomu 238
tobira 209
tobu 211
tōbu gaishō 46
tōchaku bin 213
tōdai 217
todana 66
todana rokku 75
tofi 113
tōgarashi 132, 143
toge 46
tōgei 275
togi-bō 118
tōgo 317
togurubotan 31
tōhi 39
tōi 320
toiawase 168
toire 61, 266
toire burashi 72
toiretto pēpā 72
toishi 81
tōjiki 105
- tōjōken 213
tokage 293
tokei 62, 304
tokoi-tsuki rajio 70
toko ni tsuku 71
tōkotsu 17
tokoya 39, 188
tokubai 322
tokubaihin 106
tokuten 220, 273
tōkyū suru 225, 229
tomare 323
tomato 125, 157
tomato jūsu 144, 149
tombo 295
tomegane 37
tōmei hachimitsu 134
tomodachi ni naru 26
tōmorokoshi 122, 130, 184
tōmorokoshi pan 139
ton 310
tōnamento 233
tongu 167
tonikku wōtā 144
tōnyōbyō 44
topāzu 288
topiari 87
toppingu 155
toppu 246
toppu chūbu 207
tora 291
toraffuru 113
toragu 88
torai 221
toraianguru 257
torairuru 141
torakku 194, 234
torakku no untenshu 190
torakkusūtsu 31, 32
torakutā 182
torampetto 257
torampu 273
torampu hito-kumi 273
toranku 198
toranku rūmu 196
toreddo 207
toreddomiru 250
toroi 152, 154
torekkingu 243
torēn 35
torēnā 33
torēningu suru 251
torērā 266
torerisu 84
tori 119
tōri 298
torigoya 185
torihikisaki 175
torimā 88
torinidādo tobago 314
toriniku 119
toronbōn 257
tororī basu 196
toruko 318
torukoishi 289
torukumenisutan 318
torumarin 288

toryō baketsu 83
 toryō-yō shinnā 83
 toryufu 125
 toshi 299, 306, 307
 tōshi 97
 tosho kādo 168
 tosho mokuroku 168
 toshokan 168, 299
 tosō suru 83
 tōsutā 66
 tōsuto 157
 tōsuto-sando 149
 totte 37, 88, 106
 tōyaku 109
 tōzayokin kōza 96
 tsū doa 200
 tsuarā 205
 tsubame 292
 tsubasa 210, 293
 tsubomi 111, 297
 tsubu masutādo 135
 tsubushita 132, 159
 tsuchifumazu 15
 tsūden rēru 209
 tsūgaku kaban 162
 tsugiki suru 91
 tsuihi suru 90
 tsuin rūmu 100
 tsukaisute 109
 tsukaisute kamera 270
 tsukaisute kamisori 73
 tsukeru 130
 tsuki 237, 280, 306
 tsukichakurikusen 281
 tsūkinsha 208
 tsūkō kinshi 323
 tsukue 162, 172
 tsukurō 277
 tsuma 22
 tsumaranai 321
 tsume 15, 291, 293
 tsume yasuri 41
 tsumekiri 41
 tsumekiri-basami 41
 tsumememo 50, 159
 tsumetai 321
 tsumitoru 91
 tsumu 91
 tsumujikaze 287
 tsunagi 83
 tsunagu 91
 tsuno 291
 tsurara 287
 tsuri 244
 tsuri kyokashō 245
 tsuri no shurui 245
 tsuri'ito 244
 tsuribari 244
 tsuribito 244
 tsurigane suisen 297
 tsūringu jitensha 206
 tsurisage-shiki forudā 173
 tsuriwa 235
 tsurizao 244
 tsūro 106, 168, 210, 212, 254
 tsuru 245, 292
 tsūrubā 177

tsuruhashi 187
 tsurusei shokubutsu 87
 tsutsugiri 121
 tsutsumi 311
 tsūwa-chū 99
 tsuyadashi 83
 tsuyadashizai 77
 tsuyakeshi 83
 tsuyoi 321
 tsuzuru 162

U

ubaguruma 75
 uchigawa 320
 uchiwasaboten 128
 uchū 280
 uchū sutēshon 281
 uchū tanken 281
 uchūfuku 281
 uchūhikōshi 281
 uchūkūkan 280
 uddo 233
 ude 13, 95
 udedokei 36
 udetatefuse 251
 ue e 320
 ue-kaeru 91
 ueki 87, 110
 uekibachi 89
 ueru 183
 uesuto 12
 uesutobando 35
 ugai dai 50
 uganda 317
 ugokasu 251
 uikyō 122, 133
 uikyō no tane 133
 uindo-shirudo 205
 uindoburēkā 33
 uindosāfā 241
 uindosāfin 241
 uirusu 44
 uisuki 145
 ukairo 195, 323
 uke 237
 ukegane 276
 ukeru 227
 uketsuke-gakari 190
 uki 244
 ukidama 61
 ukiwa 265
 ukon 132
 ukuraina 316
 uma 185, 242
 umareru 26
 umate 243
 umaya 185, 243
 umeru 82
 umi 264, 282
 umi no ie 264
 umibe 264
 umizuri 245
 unagi 294
 undō 251
 unmo 289
 unten seki 196
 unten shitsu 208

unten suru 195
 untendai 95
 untenshu 196
 uraji 32
 urauchi-gami 83
 ureshi 25
 uriba annai 104
 urin 285
 uroko 121, 293, 294
 uroko o totta 121
 uruguai 315
 urusai 321
 usagi 290
 usagi niku 118
 usetsu kinshi 195
 usugiri 119
 usui 321
 uta 259
 utsu 79, 224, 225, 229
 utsukushi 321
 uwagi 32
 uwanuri 83
 uwazara 310
 uyoku 229
 uzubekisutan 318
 uzura 119
 uzura mame 131
 uzura tamago 137

W

waffuru 157
 wagomu 173
 wagon 172
 waido gamen terebi 269
 wain 145, 151
 wain risuto 152
 wain su 135
 waingurasu 65
 waipā 198
 waishatsu 32
 waiyā kappu 35
 waiyā kattā 81
 waiyā sutorippā 81
 wakai 321
 waki no shita 13
 wakimichi 299
 wakkusu 41
 wakusei 280, 282
 wambokkusu kā 199
 wampisu 31, 34
 waniguchi kurippu 167
 wanshotto 151
 warau 25
 waribiki ryōkin 322
 waru 165
 warui 321
 wasabi 124
 washi 292
 wasshā 80
 wata o totta 121
 waza 237
 webusaito 177
 wēdā 244
 wedingu kēki 141
 wedingudoresu 35
 weitā 148, 152
 weito beruto 239

weito torēningu 251
 weitoresu 191
 weiji 233
 wetto tisshu 108
 wettosūtsu 239
 wiketto 225
 wiketto-kipā 225
 windō 177
 windorasu 214
 wintā supōtsu 247
 wokka 145
 wōtā gāden 84
 wōtā hazādo 232

Y

ya 249
 yachin 58
 yachō kansatsu 263
 yādo 310
 yagai katsudō 262
 yagi 185
 yagi chizu 142
 yagi-nyū 136
 yaita 159
 yakedo 46
 yakisoba 158
 yakkyoku 108
 yaku 67, 138
 yakumi 135
 yakusō 55
 yakusō-zai 108
 yakuzaiishi 108, 189
 yakyū 228
 yakyū o suru 229
 yakyūbō 36
 yama 284
 yamaimo 125
 yanagi 296
 yane 58, 203
 yane-gawara 58, 187
 yaneura-beya 58
 yaoya 114, 188
 yarinage 234
 yasai 107, 122, 124
 yasai-shitsu 67
 yasei mai 130
 yashi 296
 yashi no ki 86
 yasu ryō 245
 yasui 321
 yasuri 81
 yawarakai 129, 321
 yazutsu 249
 yoake 305
 yōbi 306
 yobidashi botan 48
 yobidashijō 180
 yobirin 59
 yobō-sesshu 45
 yodarekake 30
 yōfukudansu 70
 yoga 54
 yōgan 283
 yōgisha 94, 181
 yogoremono 76
 yōgu 233
 yōguruto 137

yōgyōjō 183
 yōhō 109
 yoi 321
 yoidome 109
 yōji 30
 yōjō shito 83
 yōkeijō 183
 yōki 311
 yōki-iri inryōsui 144
 yokogura 242
 yokushitsu 72
 yokushitsu-yō kyabinetto 72
 yokusō 72
 yōkyū 249
 yome 22
 yomu 162
 yon 308
 yon banme 309
 yōnashi 126
 yonhyaku 308
 yonjū 308
 yonjū banme 309
 yonjūppun 304
 yonrin kudōsha 199
 yontōkin 16
 yōnyū 137
 yori yoi 321
 yoroido 58
 yōroppa 316
 yoru 305
 yorudan 318
 yōryō 109, 311
 yōseki 311
 yosenami 241
 yōshi gaido 172
 yōsui 52
 yōsui senshi 52
 yotei 175
 yōtonjō 183
 yōtsui 17
 yotto 215, 240
 yowai 321
 yoyaku 45
 yoyaku suru 168
 yōzai 83
 yubi no kansetsu 15
 yūbin-bangō 98
 yūbin-bukuro 98
 yūbin haitatsunin 98
 yūbin kaban 190
 yūbin kawase 98
 yūbin posuto 99
 yūbin-uke 58, 99
 yūbinhaitatsu 190
 yūbinkyoku 98
 yūbinkyoku-in 98
 yubinuki 276
 yubiwa 36
 yuderu 67
 yudeta 159
 yudetamago 137, 157
 yūen 199
 yūenchi 262
 yūgure 305
 yūhodō 265
 yūigonjō o kaku 26
 yūjin 24

yuka 58, 62, 71
yuka undō 235
yūkari 296
yuki 287
yūki 91, 122
yūki gomi 61
yūki-sei 118
yukkurishita 321
yumi 249
yuminoko 81
yuri 110
yūryō channeru 269
yusei kan 21
yūshoku 64
yūsō-ryō 98
yusugu 38
yutampo 70
yutiririti rūmu 76
yūzai 181
yuzure 323

Z

zabuton 64, 152
zaijō 180
zaijōnimpi 180
zaimoku 187
zairyō 79
zakuro 128
zambia 317
zamen 64
zarugai 121
zaseki 209, 210, 254
zaseki haichi 254
zasshi 107, 112, 168
zassō 86
zassō kari-basami 88
zataku 152
zayaku 109
zei 96
zeikan 212, 216
zekken 226
zemu kurippu 173
zenkyō 242
zennyū 136
zenrin 196, 210
zenritsusen 21
zenryū 130
zenryū pan 139
zenryū-fun 138
zensai 153
zensoku 44
zentōdō 19
zentōkin 16
zenwan 12
zeribīnzu 113
zetsuen tēpu 81
zō 291
zōchiku bubun 58
zōen suru 91
zōsen-jo 217
zubon 32
zuga 274
zugaihotsu 17
zukkini 125
zūmu renzu 270
zunō 19
zutsū 44

英語索引 eigo sakuin • English index

A

à la carte 152
 abdomen 12
 abdominals 16
 above 320
 abseiling 248
 acacia 110
 accelerator 200
 access road 216
 accessories 36, 38
 accident 46
 account number 96
 accountant 97, 190
 accounts department 175
 accused 180
 ace 230, 273
 Achilles tendon 16
 acorn squash 125
 acquaintance 24
 acquitted 181
 across 320
 acrylic paints 274
 actions 237, 229, 227, 233, 183
 activities 263, 245, 162, 77
 actor 254, 191
 actors 179
 actress 254
 acupressure 55
 acupuncture 55
 Adam's apple 19
 add v 165
 address 98
 adhesive tape 47
 adjustable spanner 80
 admissions 168
 admitted 48
 aduki beans 131
 adult 23
 advantage 230
 adventure 255
 advertisement 269
 aerate v 91
 aerobics 251
 Afghanistan 318
 Africa 317
 after 320
 afternoon 305
 aftershave 73
 aftersun 108
 agate 289
 agenda 174
 aikido 236
 aileron 210
 air bag 201
 air conditioning 200
 air cylinder 239
 air filter 202, 204
 air letter 98
 air mattress 267
 air stewardess 190
 air supply 199
 air vent 210
 aircraft 210
 aircraft carrier 215
 airliner 210, 212
 airport 212
 aisle 106, 168, 210, 254
 alarm clock 70
 Alaska 314
 Albania 316
 alcoholic drinks 145
 alfalfa 184
 Algeria 317
 allergy 44
 alley 298
 alligator 293
 allspice 132
 almond 129
 almond oil 134
 almonds 151
 along 320
 alpine 87
 alpine skiing 247
 alternating current 60
 alternative therapy 54
 alternator 203
 altitude 211
 aluminum 289
 Amazonia 312
 ambulance 94
 American football 220
 amethyst 288
 amniocentesis 52
 amniotic fluid 52
 amount 96
 amp 60
 amphibians 294
 amplifier 268
 anchor 214, 240
 Andes 312
 Andorra 316
 anesthesiologist 48
 angle 164
 angler 244
 Angola 317
 angry 25
 animals 292, 294
 animated film 255
 ankle 13, 15
 ankle-length 34
 anniversary 26
 annual 86, 307
 anorak 31, 33
 answer 163
 answer v 99, 163
 answering machine 99
 ant 295
 antenna 295
 antifreeze 199, 203
 Antigua and Barbuda 314
 anti-inflammatory 109
 antique shop 114
 antiseptic 47
 antiseptic wipe 47
 antiwrinkle 41

antler 291
 apartment building 59, 298
 apéritif 153
 aperture dial 270
 apex 165
 appeal 181
 appearance 30
 appendix 18
 applaud v 255
 apple 126
 apple corer 68
 apple juice 149
 appliances 66
 application 176
 appointment 45, 175
 apricot 126
 April 306
 apron 30, 50, 69, 212
 APS camera 270
 aquamarine 288
 Arabian Sea 313
 arable farm 183
 arborio rice 130
 arc 164
 arch 15, 85, 301
 archery 249
 architect 190
 architecture 300
 architrave 301
 Arctic Circle 283
 Arctic Ocean 312
 area 165, 310
 areas 299
 arena 243
 Argentina 315
 arithmetic 165
 arm 13
 armband 238
 armchair 63
 Armenia 318
 armpit 13
 armrest 200, 210
 aromatherapy 55
 around 320
 arrangements 111
 arrest 94
 arrivals 213
 arrow 249
 art 162
 art college 169
 art deco 301
 art gallery 261
 art nouveau 301
 art shop 115
 artery 19
 artichoke 124
 artist 274
 arts and crafts 274, 276
 arugula 123
 ash 283
 ashtray 150
 Asia 318
 assault 94
 assistant 24
 assisted delivery 53
 asteroid 280
 asthma 44
 astigmatism 51
 astronaut 281
 astronomy 281
 asymmetric bars 235
 at 320
 athlete 234
 Atlantic Ocean 312
 atmosphere 282, 286
 atrium 104
 attachment 177
 attack 220
 attack zone 224
 attend v 174
 attic 58
 attractions 261
 auburn 39
 audience 254
 August 306
 aunt 22
 aurora 286
 Australasia 319
 Australia 319
 Austria 316
 autocue 179
 automatic 200
 automatic door 196
 autumn 31, 307
 avalanche 247
 avenue 299
 avocado 128
 awning 148
 ax 95
 axle 205
 ayurveda 55
 Azerbaijan 318

B
 baby 23, 30
 baby bath 74
 baby care 74
 baby carriage 75
 baby changing facilities 104
 baby monitor 75
 baby products 107
 baby sling 75
 babygro 30
 back 13
 back brush 73
 back seat 200
 backboard 226
 backdrop 254
 backgammon 272
 backhand 231
 backpack 31, 37, 267
 backstroke 239
 backswing 233
 bacon 118, 157
 bad 321
 badge 94

badminton 231
 bag 311
 bagel 139
 baggage claim 213
 baggage trailer 212
 bags 37
 baguette 138
 Bahamas 314
 bail 181
 bait 244
 bait v 245
 bake v 67, 138
 baked 159
 baker 139
 baker's 114
 bakery 107, 138
 baking 69
 baking tray 69
 balance wheel 276
 balcony 59, 254
 bald 39
 bale 184
 Balearic Islands 316
 ball 15, 75, 221, 224, 226, 228, 230
 ballboy 231
 ballet 255
 balsamic vinegar 135
 Baltic Sea 313
 bamboo 86, 122
 banana 128
 bandage 47
 Bangladesh 318
 banister 59
 bank 96, 284
 bank charge 96
 bank manager 96
 bank transfer 96
 bar 150, 152, 250, 256, 311
 bar code 106
 bar counter 150
 bar mitzvah 26
 bar snacks 151
 bar stool 150
 barb 244
 Barbados 314
 barbecue 267
 barber 39, 188
 bark 296
 barley 130, 184
 barman 191
 barn 182
 baroque 301
 bars 74
 bartender 150
 basalt 288
 base 164, 229
 base station 99
 baseball 228
 baseline 230
 baseman 228
 basement 58

- basil 133
 basin 50
 basket 106, 207, 226
 basket of fruit 126
 basketball 226
 basketball player 226
 bass clarinet 257
 bass clef 256
 bass guitar 258
 bass guitarist 258
 bassinet 74
 bassoon 257
 bat 225, 228, 231, 290
 bat v 225, 229
 bath mat 72
 bath towel 73
 bathrobe 73
 bathroom 72
 bathtub 72
 baton 235, 256
 batsman 225
 batter 228
 batteries 260
 battery 167, 202
 battery pack 78
 battleship 215
 bay leaf 133
 bayonet fitting 60
 be born v 26
 beach 264
 beach bag 264
 beach ball 265
 beach hut 264
 beach towel 265
 beach umbrella 264
 beaker 167
 beam 186, 235
 bean sprout 122
 beans 131, 144
 bear 291
 beat 259
 beauty 40, 105
 beauty treatments 41
 bed 70, 71
 bed and breakfast 101
 bedding 74
 bedroom 70
 bedside lamp 70
 bedside table 70
 bedspread 70
 bee 295
 beech 296
 beef 118
 beer 145, 151
 beer tap 150
 beetle 295
 beets 125
 before 320
 beginning 321
 behind 320
 Belarus 316
 Belgium 316
 Belize 314
 bell 197
 below 320
 belt 32, 36, 236
 bench 250, 262
 Benin 317
 berry 296
 beside 320
 bet 273
 between 320
 beyond 320
 Bhutan 318
 biathlon 247
 bib 30
 bicep curl 251
 biceps 16
 bicycle 206
 bicycle v 207
 bidet 72
 biennial 86
 bifocal 51
 big toe 15
 bike rack 207
 bikini 264
 bill 152, 293
 binoculars 281
 biology 162
 biplane 211
 birch 296
 bird watching 263
 birds 292
 birth 52
 birth weight 53
 birth certificate 26
 birthday 27
 birthday cake 141
 birthday candles 141
 birthday party 27
 biscuits 141
 bishop 272
 bit 242
 bit brace 78
 bite 46
 bite v 245
 bitter 124, 145
 black 39, 272, 274
 black belt 237
 black coffee 148
 black hole 280
 black olive 143
 black pudding 157
 Black Sea 313
 black tea 149
 blackberry 127
 blackboard 162
 blackcurrant 127
 black-eyed beans 131
 bladder 20
 blade 60, 66, 78, 89
 blanket 71, 74
 blazer 33
 bleach 77
 blender 66
 blister 46
 block 237
 block v 227
 blonde 39
 blood pressure 44
 blood pressure gauge 45
 blood test 48
 blouse 34
 blow dry v 38
 blow out v 141
 blowhole 290
 blue 274
 blue cheese 136
 bluebells 297
 blueberry 127
 blues 259
 blusher 40
 board 241
 board v 217
 board games 272
 boarding pass 213
 bob 39
 bobbin 276
 bobsled 247
 body 12
 body lotion 73
 body systems 19
 bodywork 202
 boil v 67
 boiled egg 137, 157
 boiler 61
 bok choy 123
 Bolivia 315
 bollard 214, 298
 bolt 59
 bomber 211
 bone 17, 119, 121
 bone meal 88
 boned 121
 bongos 257
 bonnet 198
 book 168
 book a flight v 212
 book shop 115
 bookshelf 63, 168
 boom 95, 240
 booster 281
 boot 198, 220, 223
 booties 30
 bored 25
 borrow v 168
 Bosnia and Herzegovina 316
 Botswana 317
 bottle 61, 75, 135, 311
 bottle opener 68, 150
 bottled foods 134
 bottled water 144
 bottom tier 141
 bounce v 227
 boundary line 225
 bouquet 35, 111
 bouquet garni 132
 bout 237
 boutique 115
 bow 240, 249
 bow tie 36
 bowl 61, 65, 112
 bowl v 225
 bowler 225
 bowling 249
 bowling ball 249
 box 254
 box file 173
 box of chocolates 113
 box of tissues 70
 box office 255
 boxer shorts 33
 boxercise 251
 boxing 236
 boxing gloves 237
 boxing ring 237
 boy 23
 boyfriend 24
 bra 35
 braces 50
 bracelet 36
 braid 39
 brain 19
 brake 200, 204, 206
 brake v 207
 brake block 207
 brake fluid reservoir 202
 brake lever 207
 brake pedal 205
 bran 130
 branch 175, 296
 brandy 145
 brass 256
 Brazil 315
 brazil nut 129
 bread 157
 bread knife 68
 bread roll 143
 breadcrumbs 139
 breads 138
 break a record v 234
 break waters v 52
 breakdown 203
 breakfast 64, 156
 breakfast buffet 156
 breakfast cereals 107
 breakfast table 156
 breakfast tray 101
 breast 12, 119
 breast bone 17
 breast pump 53
 breastfeed v 53
 breaststroke 239
 breathing 47
 breech 52
 brick 187
 bridge 15, 214, 258, 273, 300
 bridle 242
 bridle path 263
 brie 142
 briefcase 37
 briefs 33, 35
 brioche 157
 broadcast 179
 broadcast v 178
 broccoli 123
 brochure 175
 bronze 235
 brooch 36
 broom 77
 broth 158
 brother 22
 brother-in-law 23
 browband 242
 brown 274
 brown bread 139, 149
 brown flour 138
 brown lentils 131
 brown rice 130
 browse v 177
 browser 177
 bruise 46
 Brunei 319
 brunette 39
 brush 38, 40, 77, 83, 274
 brush v 38, 50
 brussel sprout 122
 bubble bath 73
 bucket 77, 82, 265
 buckle 36
 bud 111, 297
 buffet 152
 buggy 232
 build v 186
 builder 186, 188
 building site 186
 buildings 299
 bulb 86
 Bulgaria 316
 bull 185
 bulldog clip 173
 bullet train 209
 bull-nose pliers 80
 bullseye 273
 bumper 74, 198
 bun 39, 139, 140, 155
 bunch 111
 bungalow 58
 bungee jumping 248
 bunker 232
 bunsen burner 166
 buoy 217
 bureau de change 97
 burger 154
 burger bar 154
 burger meal 154
 burglar alarm 58
 burglary 94
 Burkina Faso 317
 Burma (Myanmar) 318
 burn 46
 burner 67
 Burundi 317
 bus 196
 bus driver 190
 bus shelter 197
 bus station 197
 bus stop 197, 299
 bus ticket 197
 buses 196
 business 175
 business class 211
 business deal 175
 business lunch 175
 business partner 24
 business suit 32
 business trip 175
 businessman 175
 businesswoman 175
 bustier 35
 butcher 118, 188
 butcher's 114
 butter 137, 156
 butter beans 131
 buttercup 297
 butterfly 239, 295
 buttermilk 137
 butternut squash 125
 buttock 13, 16
 button 32

buttonhole 32
 buttress 301
 by 320
 by airmail 98
 bytes 176

C

cab 95
 cabbage 123
 cabin 210, 214
 Cabinda 317
 cabinet 66
 cable 79, 207
 cable car 246
 cable television 269
 cactus 87
 caddy 233
 café 148, 262
 cafetière 65
 cake shop 114
 cake tin 69
 cakes 140
 calcite 289
 calcium 109
 calculator 165
 calendar 306
 calf 13, 16, 185
 call button 48
 calyx 297
 cam belt 203
 Cambodia 318
 camcorder 260, 269
 camel 291
 camembert 142
 camera 178, 260, 270
 camera case 271
 camera crane 178
 camera shop 115
 cameraman 178
 Cameroon 317
 camisole 35
 camomile tea 149
 camp v 266
 camp bed 266
 campari 145
 camper van 266
 campfire 266
 camping 266
 camping stove 267
 campsite 266
 campus 168
 can 145, 311
 can opener 68
 Canada 314
 canary 292
 candied fruit 129
 candle 63
 cane 91
 canes 89
 canine 50
 can 289, 311
 canned drink 154
 canned food 107
 canoe 214
 canoeing 241
 canter 243
 canvas 274
 cap 21, 36, 238

capacity 311
 cape gooseberry 128
 capers 143
 capital 315
 capoeira 237
 cappuccino 148
 capsiz v 241
 capsule 109
 captain 214
 car 198, 200
 car accident 203
 car hire 213
 car stereo 201
 car wash 198
 caramel 113
 caravan 266
 caraway 131
 card 27
 card phone 99
 card slot 97
 cardamom 132
 cardboard 275
 cardigan 32
 cardiology 49
 cardiovascular 19
 cards 273
 cargo 216
 Caribbean Sea 312
 carnation 110
 carnival 27
 carousel 212
 carpenter 188
 carpentry bits 80
 carpet 71
 carriage 208
 carriage race 243
 carrier 204
 carrot 124
 cart 48, 100, 106, 213
 cartilage 17
 carton 311
 cartoon 178
 carve v 79
 carving fork 68
 case 51
 cash v 97
 cash machine 97
 cashew 129, 151
 cashier 96, 106
 casino 261
 Caspian Sea 313
 casserole dish 69
 cassette player 269
 cassette tape 269
 cast 254
 cast v 245
 castle 300
 casual 34
 casual wear 33
 cat 290
 catalog 168
 catamaran 215
 cataract 51
 catch v 220, 227, 229, 245
 catcher 229
 caterpillar 295
 cathedral 300
 catheter 53

cauliflower 124
 cave 284
 CD player 268
 cedar 296
 ceiling 62
 celebration 140
 celebration cakes 141
 celebrations 27
 celeriac 124
 celery 122
 cell 181
 cello 256
 cell phone 99
 cement 186
 cement mixer 186
 centimeter 310
 centipede 295
 Central African Republic 317
 central processing unit 176
 central reservation 194
 center 164
 center circle 222, 224, 226
 center field 228
 center line 226
 centerboard 241
 century 307
 ceramic stovetop 66
 cereal 130, 156
 cervical vertebrae 17
 cervix 20, 52
 cesarean section 52
 Chad 317
 chain 36, 206
 chair 64
 chair v 174
 chairlift 246
 chalk 85, 162, 288
 chamber 283
 champagne 145
 championship 230
 change v 209
 change a wheel v 203
 change channel v 269
 change gear v 207
 changing bag 75
 changing mat 74
 changing room 104
 channel 178
 charcoal 266, 275
 charge 94, 180
 chart 48
 chassis 203
 check 96
 checkbook 96
 checkers 272
 check-in v 212
 check-in desk 213
 checkout 106
 checkup 50
 cheddar 142
 cheek 14
 cheerleader 220
 cheese 136, 156
 chef 152, 190
 chef's hat 190
 chemistry 162
 cherry 126
 cherry tomato 124

chess 272
 chessboard 272
 chest 12
 chest of drawers 70
 chest press 251
 chestnut 129
 chewing gum 113
 chick 185
 chick peas 131
 chicken 119, 185
 chicken burger 155
 chicken coop 185
 chicken nuggets 155
 chickenpox 44
 chicory 122
 child 23, 31
 child lock 75
 child seat 198, 207
 childbirth 53
 children 23
 children's clothing 30
 children's department 104
 children's ward 48
 child's meal 153
 Chile 315
 chili 124, 132, 143
 chill 44
 chimney 58
 chin 14
 China 318
 china 105
 Chinese leaves 122
 chip v 233
 chipboard 79
 chiropractic 54
 chisel 81, 275
 chives 133
 chocolate 113
 chocolate bar 113
 chocolate cake 140
 chocolate chip 141
 chocolate-coated 140
 chocolate milkshake 149
 chocolate spread 135
 choir 301
 choke v 47
 chop 119, 237
 chopping block 68
 chopsticks 64
 chorizo 143
 choux pastry 140
 christening 26
 Christmas 27
 chrysanthemum 110
 chuck 78
 church 298, 300
 chutney 134
 cider 145
 cider vinegar 135
 cigar 112
 cigarettes 112
 cilantro 133
 cinema hall 255
 cinnamon 133
 circle 165, 254
 circular saw 78
 circuit training 251
 circumference 164

cistern 61
 citrus fruit 126
 city 299
 clam 121
 clamp 78, 166
 clamp stand 166
 clapper board 179
 clarinet 257
 clasp 36
 classical music 255, 259
 classroom 162
 claw 291
 clay 85, 275
 clean v 77
 clean clothes 76
 cleaned 121
 cleaner 188
 cleaning equipment 77
 cleaning fluid 51
 cleanser 41
 clear honey 134
 cleat 240
 cleaver 68
 clementine 126
 client 38, 175, 180
 cliff 285
 climber 87
 climbing frame 263
 clinic 48
 clipboard 173
 clitoris 20
 clock 62
 clock radio 70
 closed 260, 321
 clothes line 76
 clothes peg 76
 clothing 205
 cloud 287
 cloudy 286
 clove 125
 clover 297
 cloves 133
 club 273
 club sandwich 155
 clubhouse 232
 clutch 200, 204
 coach 196
 coal 288
 coast 285
 coaster 150
 coastguard 217
 coat 32
 coat hanger 70
 cockatoo 293
 cockerel 185
 cockle 121
 cockpit 210
 cockroach 295
 cocktail 151
 cocktail shaker 150
 cocoa powder 148
 coconut 129
 cocoon 295
 cod 120
 coffee 144, 148, 153, 156, 184
 coffee cup 65
 coffee machine 148, 150
 coffee milkshake 149

- coffee spoon 153
 coffee table 62
 cog 206
 coin 97
 coin phone 99
 coin return 99
 cola 144
 colander 68
 cold 44, 286, 321
 cold faucet 72
 cold-pressed oil 135
 collage 275
 collar 32
 collarbone 17
 colleague 24
 collect call 99
 collection 98
 college 168
 Colombia 315
 colony 315
 coloring pencil 163
 colors 39, 274
 comb 38
 comb v 38
 combat sports 236
 combine harvester 182
 comedy 255
 comet 280
 comforter 71
 comic 112
 commis chef 152
 commission 97
 communications 98
 commuter 208
 Comoros 317
 compact 40
 compact disk (CD) 269
 company 175
 compartment 209
 compass 165, 312, 240
 complaint 94
 complexion 41
 compliments slip 173
 compost 88
 compost heap 85
 computer 172, 176
 concealer 40
 conceive v 20
 conception 52
 concert 255, 258
 concertina file 173
 concourse 209
 concrete block 187
 concussion 46
 condensed milk 136
 conditioner 38
 condom 21
 conductor 256
 cone 164, 187
 confectioner 113
 confectionery 107, 113
 confident 25
 confused 25
 conglomerate 288
 Congo 317
 conifer 86
 connect v 177
 connection 212
 conning tower 215
 console 269
 constellation 281
 construction 186
 consultant 49
 consultation 45
 contact lenses 51
 container 216, 311
 container port 216
 container ship 215
 continent 282, 315
 contraception 21, 52
 contraction 52
 control tower 212
 controller 269
 controls 201, 204
 convector heater 60
 convenience food 107
 convertible 199
 conveyer belt 106
 cooked meat 118, 143
 cookie 113
 cooking 67
 coolant reservoir 202
 cooling rack 69
 copilot 211
 copper 289
 copy v 172
 coral reef 285
 cordless phone 99
 core 127
 cork 134
 corkscrew 150
 corn 122, 130, 184
 cornbread 139
 corn oil 135
 cornea 51
 corner 223
 corner flag 223
 cornice 300
 corset 35
 Corsica 316
 Costa Rica 314
 costume 255
 cot 74
 cottage cheese 136
 cottage garden 84
 cotton 184, 277
 cotton balls 41
 cough 44
 cough medicine 108
 counselor 55
 count v 165
 counter 96, 98, 100, 142, 272
 country 259, 315
 couple 24
 courier 99
 courses 153
 court 226
 court case 180
 court date 180
 court officer 180
 court official 180
 courtroom 180
 courtyard 58, 84
 couscous 130
 cousin 22
 cow 185
 cow's milk 136
 crab 121, 295
 cracked wheat 130
 cradle 95
 craft knife 82
 crafts 275
 cramp 239
 cramps 44
 cranberry 127
 crane 187, 216, 292
 crash barrier 195
 crater 283
 crayfish 121
 cream 109, 137, 140, 157
 cream cheese 136
 cream pie 141
 crease 225
 credit card 96
 creel 245
 creeper 87
 crème caramel 141
 crème pâtisserie 140
 crêpe 155
 crescent moon 280
 crew 241
 crew hatch 281
 cricket 225, 295
 cricket ball 225
 cricketer 225
 crime 94
 criminal 181
 criminal record 181
 crisp 127
 crispbread 139, 156
 crispier 67
 crisps 113, 151
 Croatia 316
 crochet 277
 crochet hook 277
 crocodile 293
 crocodile clip 167
 croissant 156
 crop 39, 183
 crops 184
 cross trainer 250
 crossbar 207, 222, 235
 cross-country skiing 247
 crow 292
 crown 50
 crucible 166
 crushed 132
 crust 139, 282
 cry v 25
 crystal healing 55
 Cuba 314
 cube 164
 cucumber 125
 cuff 32, 45
 cufflink 36
 cultivate v 91
 cultivator 182
 cumin 132
 curb 298
 cured 118, 159, 143
 curler 38
 curling 247
 curling tongs 38
 curly 39
 currant 129
 current account 96
 curry 158
 curry powder 132
 curtain 63, 254
 curved 165
 cushion 62
 custard 140
 customer 96, 104, 106, 152
 customer service department 175
 customer services 104
 customs 212
 customs house 216
 cut 46
 cut v 38, 79, 277
 cuticle 15
 cuts 119
 cutting 91
 cuttlefish 121
 cycle lane 206
 cycling 263
 cylinder 164
 cylinder head 202
 cymbals 257
 Cyprus 318
 Czech Republic 316

D
 daffodil 111
 dairy 107
 dairy farm 183
 dairy produce 136
 daisy 110, 297
 dam 300
 dance 259
 dance academy 169
 dancer 191
 dandelion 123, 297
 dandruff 39
 dark 41, 321
 dark chocolate 113
 darkroom 271
 darn v 277
 dartboard 273
 darts 273
 dashboard 201
 date 129, 306
 daughter 22
 daughter-in-law 22
 dawn 305
 day 305, 306
 dead ball line 221
 deadhead v 91
 deal v 273
 debit card 96
 decade 307
 decay 50
 December 306
 deciduous 86
 decimal 165
 deck 214
 deck chair 265
 decking 85
 decorating 82
 decoration 141
 decorator 82
 deep end 239
 deep-fried 159
 deep sea fishing 245
 deer 291
 defense 181, 220
 defendant 181
 defender 223
 defending zone 224
 defrost v 67
 degree 169
 delay 209
 deli 107
 delicatessen 142
 delivery 52, 98
 deltoid 16
 Democratic Republic of the Congo 317
 Denmark 316
 denomination 97
 denominator 165
 dental care 108
 dental floss 50, 72
 dental hygiene 72
 dental x-ray 50
 dentist 50, 189
 dentist's chair 50
 dentures 50
 deodorant 73
 deodorants 108
 department 169
 department store 105
 departments 49
 departure lounge 213
 departures 213
 deposit slips 96
 depth 165
 dermatology 49
 descaled 121
 desert 285
 desiccated 129
 designer 191, 277
 desk 162, 172
 desktop 177
 desktop organizer 172
 dessert 140, 153
 destination 213
 detached 58
 detective 94
 detergent 77
 deuce 230
 develop v 271
 diabetes 44
 diagonal 164
 dial v 99
 diameter 164
 diamond 273, 288
 diaphragm 19, 21
 diaper 75
 diaper rash cream 74
 diarrhea 44, 109
 diary 175
 dice 272
 dictionary 163
 die v 26
 diesel 199
 diesel train 208

difficult 321
dig v 90, 227
digestive 19
digital 269
digital camera 270
dilation 52
dill 133
dimensions 165
dimple 15
dining car 209
dining room 64
dinner 64, 158
dinner plate 65
diopter 51
diploma 169
dipstick 202
direct current 60
direct debit 96
directions 260
director 254
directory assistance 99
dirt bike 205
dirty washing 76
disabled parking 195
discharged 48
disconnected 99
discus 234
discuss v 163
disembark v 217
dishes 64, 65
dishwasher 66
disinfectant solution 51
disk 176
dispensary 108
disposable 109
disposable camera 270
disposable diaper 30
disposable razor 73
dissertation 169
distance 310
distributor 203
district 315
dive 239
dive v 238
diver 238
diversion 195
divide v 165
divided by 165
divided highway 195
dividends 97
divider 173, 194
divorce 26
Diwali 27
DJ 179
Djibouti 317
do not bend v 98
dock 214, 216
dock v 217
doctor 45, 189
doctorate 169
documentary 178
dog 290
dog sledding 247
doll 75
doll's house 75
dolphin 290
dome 300
domestic flight 212

domestic supply 60
Dominica 314
Dominican Republic 314
dominoes 273
donkey 185
door 196, 198, 209
door chain 59
door knob 59
door knocker 59
door lock 200
doorbell 59
doormat 59
dormer 58
dorsal fin 294
dosage 109
double 151
double bass 256
double bassoon 257
double bed 71
double cream 137
double room 100
double-decker bus 196
doubles 230
dough 138
Dover sole 120
down 320
downhill skiing 247
download v 177
dragonfly 295
drain 61, 72, 299
drain cock 61
drainage 91
draining board 67
draw 223
draw v 162
drawer 66, 70, 172
drawer unit 172
drawing 275
dress 31, 34
dressage 243
dressed 159
dressed chicken 119
dressing 47, 158
dressing gown 31, 32
dressing table 71
dribble v 223
dried flowers 111
dried fruit 156
drill 50
drill v 79
drill bit 78
drill bits 80
drinking cup 75
drinking fountain 262
drinks 107, 144, 156
drip 53
drive v 195, 233
driver 196
driver's cab 208
driver's seat 196
driveshaft 202
drop anchor v 217
drop cloth 83
dropper 109, 167
drops 109
dropshot 230
drown v 239

drugstore 108
drum 258
drum kit 258
drummer 258
dry 39, 41, 130, 145, 286, 321
dry v 76
dry cleaners 115
dry dock 217
duck 119, 185
duck egg 137
duckling 185
duffel coat 31
dugout 229
dumb bell 251
dump truck 187
dunk v 227
duodenum 18
dusk 305
dust v 77
dustcloth 77
dustpan 77
duty-free shop 213
DVD disk 269
DVD player 268
dyed 39
dynamo 207

E

eagle 292
ear 14
early 305, 320
earring 36
Earth 280, 282
earthenware dish 69
earthing 60
earthquake 283
easel 174, 274
east 312
East Timor 319
Easter 27
easy 321
easy cook 130
eat v 64
eat-in 154
eating 75
eau de toilette 41
eaves 58
éclair 140
eclipse 280
economics 169
economy class 211
Ecuador 315
eczema 44
Edam 142
edge 246
editor 191
eel 294
egg cup 65, 137
eggplant 125
eggs 20, 137
egg white 137
Egypt 317
eight 308
eight hundred 308
eighteen 308
eighteenth 309
eighth 309

eightieth 309
eighty 308
ejaculatory duct 21
El Salvador 314
elbow 13
electric blanket 71
electric drill 78
electric guitar 258
electric razor 73
electric shock 46
electric train 208
electrical goods 105, 107
electrician 188
electricity 60
electricity meter 60
elephant 291
elevator 59, 100, 104
eleven 308
eleventh 309
elm 296
email 98, 177
email account 177
email address 177
embarrassed 25
embossed paper 83
embroidery 277
embryo 52
emerald 288
emergency 46
emergency exit 210
emergency lever 209
emergency phone 195
emergency room 48
emergency services 94
emigrate v 26
emotions 25
employee 24
employer 24
empty 321
emulsion 83
enamel 50
encore 255
encyclopedia 163
end 321
end zone 220
endive 123
endline 226
endocrine 19
endocrinology 49
engaged/busy 99
engaged couple 24
engine 202, 204, 208, 210
engine room 214
engineering 169
English breakfast 157
English horn 257
english mustard 135
engraving 275
enlarge v 172
enlargement 271
enquiries 168
ENT 49
entrance 59
entrance fee 260
envelope 98, 173
environment 280
epidural 52
epiglottis 19

epilepsy 44
episiotomy 52
equals 165
equation 165
equator 283
equipment 233, 238
equipment 165
Equatorial Guinea 317
equity 97
Eritrea 317
erupt v 283
escalator 104
esophagus 19
espresso 148
essay 163
essential oils 55
Estonia 316
estuary 285
Ethiopia 317
eucalyptus 296
Europe 316
evening 305
evening dress 34
events 243, 247
evergreen 86
evidence 181
examination 163
excess baggage 212
exchange rate 97
excited 25
excuse me 322
executive 174
exercise bike 250
exercises 251
exfoliate v 41
exhaust pipe 203, 204
exhibit v 261
exhibition 261
exit 210
exit ramp 194
exosphere 286
expectant 52
experiment 166
expiration date 109
exposure 271
extend v 251
extension 58
extension lead 78
exterior 198
extra time 223
extraction 50
extractor 66
eye 14, 51, 244, 276
eye shadow 40
eye test 51
eyebrow 14, 51
eyebrow brush 40
eyebrow pencil 40
eyecup 269
eyelash 14, 51
eyelet 37
eyelid 51
eyeliner 40
eyepiece 167

F

fabric 277
fabric conditioner 76

- face 14
 face cream 73
 face mask 225
 face pack 41
 face powder 40
 face-off circle 224
 facial 41
 factory 299
 faint v 25, 44
 fair 41
 fairground 262
 fairway 232
 falcon 292
 Falkland Islands 315
 fall 237
 fall in love v 26
 fallopian tube 20
 family 22
 famous ruin 261
 fan 60, 202
 fan belt 203
 fans 258
 far 320
 fare 197, 209
 farm 182, 183, 184
 farmer 182, 189
 farmhouse 182
 farmland 182
 farmyard 182
 farsightedness 51
 fashion 277
 fast 321
 fast food 154
 fast forward 269
 fastening 37
 fat 119, 321
 fat free 137
 fat-free milk 136
 father 22
 father-in-law 23
 faucet 61, 66
 fault 230
 fax 98, 172
 fax machine 172
 fava bean 122
 feather 293
 feature film 269
 February 306
 feed v 183
 feijoa 128
 female 12, 20
 feminine hygiene 108
 femur 17
 fence 85, 182, 243
 fencing 249
 feng shui 55
 fennel 122, 133
 fennel seeds 133
 fenugreek 132
 fern 86
 ferry 215, 216
 ferry terminal 216
 fertilization 20
 fertilize v 91
 fertilizer 91
 festivals 27
 fetus 52
 fever 44
 fiancé 24
 fiancée 24
 fiber 127
 fibula 17
 field 182, 222, 225, 228, 234
 field v 225, 229
 field hockey 224
 fifteen 308
 fifteenth 309
 fifth 309
 fiftieth 309
 fifty 308
 fifty-five thousand, five hundred 309
 fifty thousand 309
 fig 129
 fighter plane 211
 figure skating 247
 Fiji 319
 filament 60
 file 81, 172, 177
 filing cabinet 172
 fill v 82
 filler 83
 fillet 119, 121
 filleted 121
 filling 50, 140, 155
 film 271
 film set 179
 film spool 271
 filo pastry 140
 filter 270
 filter coffee 148
 filter paper 167
 fin 210, 239
 finance 97
 financial advisor 97
 fingerprint 94
 finial 300
 finishing line 234
 Finland 316
 fire 95
 fire alarm 95
 fire department 95
 fire engine 95
 fire escape 95
 fire extinguisher 95
 fire fighters 95
 fire station 95
 firelighter 266
 fireman 189
 fireplace 63
 firm 124
 first 309
 first aid 47
 first aid box 47
 first floor 104
 first night 254
 fish 107, 120, 294
 fish and chips 155
 fish farm 183
 fisherman 189
 fishhook 244
 fishing 244, 245
 fishing boat 217
 fishing permit 245
 fishing port 217
 fishing rod 244
 fishmonger 188
 fishmonger's 114, 120
 fist 15, 237
 fitness 250
 five 308
 five hundred 308
 flag 221, 232
 flageolet beans 131
 flakes 132
 flamingo 292
 flan 142
 flan dish 69
 flare 240
 flash 270
 flash gun 270
 flashlight 267
 flask 166
 flat 59, 256
 flatbread 139
 flat race 243
 flat wood bit 80
 flavored oil 134
 flax 184
 fleece 74
 flesh 124, 127, 129
 flex v 251
 flight attendant 210
 flight number 213
 flint 288
 flipchart 174
 flip-flop 37
 flipper 290
 float 238, 244
 float ball 61
 flock 183
 flood 287
 floor 58, 62, 71
 floor exercises 235
 floor plan 261
 florentine 141
 floret 122
 florist 110, 188
 floss v 50
 flours 138
 flower 297
 flowerbed 85, 90
 flowering plant 297
 flowering shrub 87
 flowers 110
 flu 44
 flute 139, 257
 fly 244, 295
 fly v 211
 fly fishing 245
 flyover 194
 flysheet 266
 foal 185
 focus v 271
 focusing knob 167
 fog 287
 foil 249
 folder 177
 foliage 110
 folk music 259
 follicle 20
 font 177
 food 118, 130, 149
 food processor 66
 foot 12, 15, 310
 football 220
 football field 220
 football player 220
 footboard 71
 footpath 262
 footstrap 241
 for 320
 forceps 53, 167
 forearm 12
 forecourt 199
 forehand 231
 forehead 14
 foreign currency 97
 foreskin 21
 forest 285
 fork 65, 88, 153, 207
 fork-lift truck 186, 216
 formal garden 84
 formal gardens 262
 fortieth 309
 fortnight 307
 forty 308
 forty minutes 304
 forward 222
 foul 222, 226
 foul ball 228
 foul line 229
 foundation 40
 fountain 85
 four 308
 four hundred 308
 four-door 200
 fourteen 308
 fourteenth 309
 fourth 309
 four-wheel drive 199
 fox 290
 foxglove 297
 fraction 165
 fracture 46
 fragile 98
 fragranced 130
 frame 51, 62, 206, 267
 frame counter 270
 France 316
 freckle 15
 free 321
 free kick 222
 free range 118
 free weights 250
 freesia 110
 free-throw line 226
 freeze 287
 freeze v 67
 freezer 67
 freight train 208
 freighter 215
 French bean 122
 french fries 154
 French Guiana 315
 French horn 257
 french mustard 135
 french pleat 39
 French toast 157
 frequency 179
 fresh 121, 127, 130
 fresh cheese 136
 freshwater fishing 245
 fret 258
 fretsaw 81
 Friday 306
 fried 159
 fried chicken 155
 fried egg 157
 fried noodles 158
 friend 24
 frieze 301
 frog 294
 from 320
 front crawl 239
 front door 58
 front wheel 196
 frontal 16
 frost 287
 froth 148
 frown 25
 frozen 121, 124
 frozen food 107
 frozen yogurt 137
 fruit 107, 126, 128
 fruit bread 139
 fruit cake 140
 fruit farm 183
 fruit gum 113
 fruit juice 127, 156
 fruit salad 157
 fruit tart 140
 fruit yogurt 157
 fry v 67
 frying pan 69
 fuel gauge 201
 fuel tank 204
 full 64, 266, 321
 full board 101
 full moon 280
 fumble 220
 funeral 26
 funnel 166, 214
 furniture store 115
 furrow 183
 fuse 60
 fuse box 60, 203
 fuselage 210
 futon 71
 G
 gable 300
 Gabon 317
 Galapagos Islands 315
 galaxy 280
 gale 286
 galley 214
 gallon 311
 gallop 243
 galvanized 79
 Gambia 317
 game 119, 230, 273
 game show 178
 games 272
 gangway 214
 garage 58, 199
 garden 84
 garden center 115
 garden features 84

- garden pea 122
 garden plants 86
 garden styles 84
 garden tools 88
 gardener 188
 gardening 90
 gardening gloves 89
 gardens 261
 garland 111
 garlic 125, 132
 garlic press 68
 garnet 288
 garter 35
 gas burner 61
 gasket 61
 gasoline 199
 gas pump 199
 gas station 199
 gas tank 203
 gate 85, 182, 247
 gate number 213
 gauze 47, 167
 gear lever 207
 gearbox 202, 204
 gears 206
 gearstick 201
 gel 38, 109
 gems 288
 generation 23
 generator 60
 genitals 12
 geography 162
 geometry 165
 Georgia 318
 gerbera 110
 Germany 316
 get a job v 26
 get married v 26
 get up v 71
 geyser 285
 Ghana 317
 giant slalom 247
 gift shop 114
 gill 294
 gin 145
 gin and tonic 151
 ginger 39, 125, 133
 giraffe 291
 girder 186
 girl 23
 girlfriend 24
 girth 242
 glacier 284
 gladiolus 110
 gland 19
 glass 69, 152
 glass bottle 166
 glass rod 167
 glasses 51, 150
 glassware 64
 glaze v 139
 glider 211, 248
 gliding 248
 gloss 83, 271
 glove 224, 233, 236, 246
 gloves 36
 glue 275
 glue gun 78
- gneiss 288
 go to bed v 71
 go to sleep v 71
 goal 221, 223, 224
 goal area 223
 goal line 220, 223, 224
 goalkeeper 222, 224
 goalpost 220, 222
 goat 185
 goat's cheese 142
 goat's milk 136
 goggles 238, 247
 going out 75
 gold 235, 289
 goldfish 294
 golf 232
 golf bag 233
 golf ball 233
 golf cart 233
 golf clubs 233
 golf course 232
 golf shoe 233
 golfer 232
 gong 257
 good 321
 good afternoon 322
 good evening 322
 good morning 322
 good night 322
 goodbye 322
 goose 119, 293
 goose egg 137
 gooseberry 127
 gorge 284
 gorilla 291
 gothic 301
 grade 163
 graduate 169
 graduate v 26
 graduation ceremony 169
 graft v 91
 grains 130
 gram 310
 granary bread 139
 grandchildren 23
 granddaughter 22
 grandfather 22
 grandmother 22
 grandparents 23
 grandson 22
 granite 288
 grape juice 144
 grapefruit 126
 grapeseed oil 134
 graphite 289
 grass 86, 262
 grass bag 88
 grasshopper 295
 grassland 285
 grate v 67
 grated cheese 136
 grater 68
 gratin dish 69
 gravel 88
 gravity 280
 gray 39, 274
 graze 46
- greasy 39
 Greece 316
 green 129, 232, 274
 green olive 143
 green onion 125
 green peas 131
 green salad 158
 green tea 149
 greengrocer 188
 greengrocer's 114
 greenhouse 85
 Greenland 314
 Grenada 314
 grill v 67
 grill pan 69
 grilled 159
 groceries 105, 106
 grocer's 114
 groin 12
 groom 243
 ground 132
 ground coffee 144
 ground cover 87
 ground floor 104
 ground sheet 267
 group therapy 55
 grout 83
 guard 236
 Guatemala 314
 guava 128
 guest 64, 100
 guidebook 260
 guided tour 260
 guilty 181
 Guinea 317
 Guinea-Bissau 317
 guitarist 258
 gull 292
 gum 50
 gun 94
 gutter 58, 299
 guy rope 266
 Guyana 315
 gym 101, 250
 gym machine 250
 gymnast 235
 gymnastics 235
 gynecologist 52
 gynecology 49
 gypsophila 110
- H**
- hacksaw 81
 haddock 120
 hemorrhage 46
 hail 286
 hair 14, 38
 hair dye 40
 hairband 38
 hairdresser 38, 188
 hairdryer 38
 hairpin 38
 hairspray 38
 hairtie 39
 Haiti 314
 half an hour 304
 half board 101
 half time 223
- half-liter 311
 halibut fillets 120
 Halloween 27
 hallway 59
 halter 243
 halter neck 35
 ham 119, 143, 156
 hammer 80
 hammer v 79
 hammock 266
 hamper 263
 hamster 290
 hamstring 16
 hand 13, 15
 hand drill 81
 hand fork 89
 hand luggage 211, 213
 hand rail 59
 hand saw 89
 hand towel 73
 handbag 37
 handbrake 203
 handcuffs 94
 handicap 233
 handkerchief 36
 handle 36, 88, 106, 187, 200, 230
 handlebar 207
 handles 37
 handrail 196
 handsaw 80
 handset 99
 hang v 82
 hang-glider 248
 hang-gliding 248
 hanging basket 84
 hanging file 173
 happy 25
 harbor 217
 harbor master 217
 hard 129, 321
 hard candy 113
 hard cheese 136
 hard drive 176
 hard hat 186
 hard shoulder 194
 hardboard 79
 hardware 176
 hardware store 114
 hardwood 79
 haricot beans 131
 harness race 243
 harp 256
 harvest v 91, 183
 hat 36
 hatchback 199
 have a baby v 26
 Hawaii 314
 hay 184
 hayfever 44
 hazard 195
 hazard lights 201
 hazelnut 129
 hazelnut oil 134
 head 12, 19, 81, 230
 head v 222
 head injury 46
 head office 175
- headache 44
 headboard 70
 headlight 198, 205
 headphones 268
 headrest 200
 headsail 240
 health 44
 health center 168
 health food shop 115
 heart 18, 119, 122, 273
 heart attack 44
 heater 60
 heater controls 201
 heather 297
 heating element 61
 heavy 321
 heavy metal 259
 hedge 85, 90, 182
 hedgehog 290
 heel 13, 15, 37
 height 165
 height bar 45
 helicopter 211
 hello 322
 helmet 95, 204, 206, 220, 224, 228
 hem 34
 hematite 289
 hen's egg 137
 herb 55, 86, 133, 134
 herbaceous border 85
 herbal remedies 108
 herbal tea 149
 herbalism 55
 herb garden 84
 herbicide 183
 herbs and spices 132
 herd 183
 hexagon 164
 hi-fi system 268
 high 321
 high chair 75
 high dive 239
 high heel shoe 37
 high jump 235
 high speed train 208
 highlights 39
 hiking 263
 hill 284
 Himalayas 313
 hip 12
 hippopotamus 291
 historic building 261
 history 162
 history of art 169
 hit v 224
 hockey 224
 hockey stick 224
 hoe 88
 hold 215, 237
 holdall 37
 hole 232
 hole in one 233
 hole punch 173
 holiday 212
 holiday brochure 212
 holly 296
 home 58

- home delivery 154
home entertainment 268
home furnishings 105
home plate 228
homeopathy 55
homework 163
homogenized 137
Honduras 314
honeycomb 135
honeymoon 26
honeysuckle 297
hood 31, 75
hoof 242, 291
hook 187, 276
hoop 226, 277
horizontal bar 235
hormone 20
horn 201, 204, 291
horror film 255
horse 185, 235, 242
horse race 243
horseback riding 242, 263
horseradish 125
horseshoe 242
hose 95
hose reel 89
hosepipe 89
hospital 48
hot 124, 286, 321
hot chocolate 144, 156
hot dog 155
hot drinks 144
hot faucet 72
hot-air balloon 211
hotel 100, 264
hot-water bottle 70
hour 304
hour hand 304
house 58
household products 107
hovercraft 215
hub 206
hubcap 202
hull 214, 240
humerus 17
humid 286
hummingbird 292
hump 291
hundred 308
hundred and ten 308
hundred thousand 308
hundredth 309
Hungary 316
hungry 64
hurdles 235
hurricane 287
husband 22
husk 130
hydrant 95
hydrofoil 215
hydrotherapy 55
hypnotherapy 55
hypoallergenic 41
hypotenuse 164
- I
ice 120, 287
ice and lemon 151
ice bucket 150
ice climbing 247
ice cream 137, 149
ice cube 151
iced coffee 148
iced tea 149
ice hockey 224
ice hockey player 224
ice hockey rink 224
ice maker 67
ice skate 224
ice skating 247
icicle 287
icing 141
icon 177
identity badge 189
identification tag 53
igneous 288
ignition 200
iguana 293
illness 44
immigration 212
impotent 20
in 320
in brine 143
in front of 320
in oil 143
in sauce 159
in syrup 159
inbox 177
inch 310
incisor 50
incubator 53
index finger 15
India 318
Indian Ocean 312
indicator 198, 204
indigo 274
Indonesia 319
induce labor v 53
industrial complex 299
infant carrier 75
infection 44
infertile 20
infield 228
inflatable dinghy 215
information 261
information screen 213
in-goal area 221
inhaler 44, 109
injection 48
injury 46
ink 275
ink pad 173
inlet 61
inner core 282
inner tube 207
inning 228
innocent 181
inoculation 45
insect repellent 108, 267
inside 320
inside lane 194
insomnia 71
inspector 94
install v 177
instant camera 270
instep 15
instructions 109
instruments 256, 258
insulating tape 81
insulation 61
insulin 109
insurance 203
intensive care unit 48
inter-city train 209
intercom 59
intercostal 16
intercourse 20
interest rate 96
interior 200
internal systems 60
international flight 212
internet 177
intersection 298
interval 254
interviewer 179
into 320
in-tray 172
invertibrates 295
investigation 94
investment 97
ionosphere 286
Iran 318
Iraq 318
Ireland 316
iris 51, 110
iron 76, 109, 233, 289
iron v 76
ironing board 76
island 282
Israel 318
Italy 316
itinerary 260
IUD 21
Ivory Coast 317
- J
jack 203, 273
jacket 32, 34
jade 288
jail cell 94
jam 134, 156
Jamaica 314
January 306
Japan 318
Japanese teacup 64
Japanese floor cushion 64, 152
Japanese horseradish 124
Japanese low table 152
jar 134, 311
javelin 234
jaw 14, 17
jazz 259
jeans 31
jelly bean 113
jellyfish 295
Jerusalem artichoke 125
jet 288
jet skiing 241
jetty 217
jeweler 188
jeweler's 114
jewelry 36
jewelry box 36
jewelry making 275
jigsaw puzzle 78
jigsaw puzzle 273
jodpurs 242
jog on the spot 251
jogging 251, 263
joint 17, 119
joker 273
Jordan 318
journal 168
journalist 190
judge 180
judo 236
juices and milkshakes 149
juicy 127
July 306
jump 237, 243
jump v 227
jump ball 226
junction 194
June 306
Jupiter 280
jury 180
jury box 180
- K
kale 123
Kaliningrad 316
kangaroo 291
karate 236
kayak 241
Kazakhstan 318
kebab 155, 158
keel 214
keep net 244
kendo 236
Kenya 317
kernel 122, 129, 130
ketchup 135
kettle 66
kettledrum 257
key 59, 80, 176, 207
keyboard 172, 176, 258
keypad 97, 99
kick 237, 239
kick v 221, 223
kickboxing 236
kickstand 207
kid 185
kidney 18, 119
kilogram 310
kilometer 310
kimono 35
king 272, 273
king prawn 121
kippers 157
kitchen 66, 152
kitchen knife 68
kitchenware 68, 105
kitten 290
kiwifruit 128
knead v 138
knee 12
knee pad 205
knee support 227
kneecap 17
knee-length 34
knickers 35
knife 65, 80
knife sharpener 68, 118
knight 272
knitting 277
knitting needle 277
knock out 237
knuckle 15
koala 291
kohlrabi 123
koi carp 294
kumquat 126
kung fu 236
Kuwait 318
Kyrgyzstan 318
- L
label 172
labels 89
labia 20
laboratory 166
lace 35, 37
lace bobbin 277
lace making 277
lace-up 37
lacrosse 249
lactose 137
ladder 95, 186
ladle 68
ladybug 295
lake 285
lamb 118, 185
lamp 62, 207, 217
land 282
land v 211
landing 59
landing gear 210
landing net 244
landlord 58
landscape 271, 284
landscape v 91
lane 234, 238
languages 162
Laos 318
lapel 32
laptop 175
larch 296
large 321
large intestine 18
larynx 19
last week 307
lat 16
late 305
later 304
latitude 283
Latvia 316
laugh v 25
launch 281
launch pad 281
laundrette 115
laundry 76
laundry basket 76
laundry service 101
lava 283
law 169, 180
lawn 85, 90
lawn rake 88
lawnmower 88, 90

lawyer 180, 190
 lawyer's office 180
 laxative 109
 lead singer 258
 leaded 199
 leaf 122, 296
 leaflets 96
 league 223
 lean meat 118
 learn v 163
 leather shoe 37
 leather shoes 32
 leathers 205
 Lebanon 318
 lecture theater 169
 lecturer 169
 leek 125
 left 260
 left field 228
 left-hand drive 201
 leg 12, 119
 leg pad 225
 leg press 251
 legal advice 180
 legal department 175
 leggings 31
 legumes 130
 leisure 258, 254, 264
 lemon 126
 lemon curd 134
 lemon grass 133
 lemon sole 120
 lemonade 144
 length 165, 310
 lens 270
 lens (eye) 51
 lens (glasses) 51
 lens cap 270
 lens case 51
 Lesotho 317
 lesson 163
 let! 231
 letter 98
 letterbox 58, 99
 letterhead 173
 lettuce 123
 lever 61, 150
 lever arch file 173
 Liberia 317
 librarian 168, 190
 library 168, 299
 library card 168
 Libya 317
 license plate 198
 licorice 113
 lid 61, 66
 Liechtenstein 316
 life events 26
 life jacket 240
 life raft 240
 lifeboat 214
 lifebuoy 240
 lifeguard 239, 265
 lifeguard tower 265
 ligament 17
 light 178, 321
 light a fire v 266
 light aircraft 211

light bulb 60
 lighter 112
 lighthouse 217
 lighting 105
 lightmeter 270
 lightning 287
 lights 94
 lights switch 201
 lily 110
 lima beans 131
 lime 126, 296
 limestone 288
 limousine 199
 line 244
 line judge 220
 line of play 233
 linen 105, 277
 linen basket 76
 lines 165
 linesman 223, 230
 lingerie 35, 105
 lining 32
 lining paper 83
 link 36
 lintel 186
 lion 291
 lip 14
 lip brush 40
 lip gloss 40
 lip liner 40
 lipstick 40
 liqueur 145
 liquid 77
 liquid dispenser 311
 liquid measure 311
 liquor store 115
 literature 162, 169
 Lithuania 316
 liter 311
 little finger 15
 little toe 15
 live 60, 178
 live rail 209
 liver 18, 118
 livestock 183, 185
 living room 62
 lizard 293
 load v 76
 loaf 139
 loan 96, 168
 loans desk 168
 lob 230
 lobby 100, 255
 lobster 121, 295
 lock 59, 207
 lockers 239
 log on v 177
 loganberry 127
 logo 31
 loin 121
 lollipop 113
 long 32
 long jump 235
 long wave 179
 long-grain 130
 long-handled shears 88
 longitude 283
 loofah 73

loom 277
 loose leaf tea 144
 lorry 194
 lorry driver 190
 lose v 273
 loser 273
 lottery tickets 112
 love 230
 low 321
 luge 247
 luggage 100, 198, 213
 luggage department 104
 luggage hold 196
 luggage rack 209
 lumbar vertebrae 17
 lunar module 281
 lunch 64
 lunch box 154
 lung 18
 lunge 251
 lupins 297
 lure 244
 Luxembourg 316
 lychee 128
 lymphatic 19
 lyrics 259

M
 macadamia 129
 lip gloss 40
 lip liner 40
 lip stick 40
 liqueur 145
 machinery 187
 mackerel 120
 macramé 277
 Madagascar 317
 magazine 107, 112
 magazines 107
 magma 283
 magnesium 109
 magnet 167
 maid service 101
 mailbag 98, 190
 mailbox 99
 mailman 98, 190
 main course 153
 mainsail 240
 make a will v 26
 make friends v 26
 make the bed v 71
 makeup 40
 making bread 138
 malachite 288
 Malawi 317
 Malaysia 318
 Maldives 318
 male 12, 21
 Mali 317
 mallet 78, 275
 malt vinegar 135
 Malta 316
 malted drink 144
 mammals 290
 man 23
 manager 24, 174
 managing director 175
 manchego 142
 mane 242, 291

mango 128
 manhole 299
 manicure 41
 mantelpiece 63
 mantle 282
 manual 200
 map 195, 261
 maple 296
 maple syrup 134
 maracas 257
 marathon 234
 marble 288
 March 306
 margarine 137
 marina 217
 marinated 143, 159
 marine fishing 245
 marjoram 133
 mark v 227
 market 115
 marketing department 175
 marmalade 134, 156
 marrow 124
 Mars 280
 marshmallow 113
 martial arts 237
 martini 151
 marzipan 141
 mascara 40
 mashed 159
 masher 68
 mask 189, 228, 236, 239, 249
 masking tape 83
 masonry bit 80
 massage 54
 mast 240
 masters 169
 mat 54, 83, 235, 271
 match 230
 matches 112
 material 276
 materials 79, 187
 maternity 49
 maternity ward 48
 math 162, 164
 mattress 70, 74
 Mauritiana 317
 Mauritius 317
 May 306
 maybe 322
 mayonnaise 135
 MDF 79
 meadow 285
 meal 64
 measles 44
 measure 150, 151
 measure v 310
 measurements 165
 measuring cup 69, 311
 measuring spoon 109
 meat 119
 meat and poultry 106
 meat tenderizer 68
 meatballs 158
 meathook 118
 mechanic 188, 203
 mechanical digger 187

mechanics 202
 medals 235
 media 178
 medical examination 45
 medication 109
 medicine 109, 169
 medicine cabinet 72
 meditation 54
 Mediterranean Sea 313
 medium wave 179
 meeting 174
 meeting room 174
 melody 259
 melon 127
 memory 176
 men's clothing 32
 men's wear 105
 menstruation 20
 menu 148, 153, 154
 menubar 177
 mercury 289
 Mercury 280
 meringue 140
 mesosphere 286
 messages 100
 metacarpal 17
 metal 79
 metal bit 80
 metals 289
 metamorphic 288
 metatarsal 17
 meteor 280
 meter 310
 Mexico 314
 mica 289
 microlight 211
 microphone 179, 258
 microscope 167
 microwave oven 66
 midday 305
 middle finger 15
 middle lane 194
 midnight 305
 midwife 53
 migraine 44
 mile 310
 milk 136, 156
 milk v 183
 milk carton 136
 milk chocolate 113
 milkshake 137
 millennium 307
 millet 130
 milligram 310
 milliliter 311
 millimeter 310
 mince 119
 mineral 144, 289
 mini bar 101
 mini disk recorder 268
 minibus 197
 mint 113, 133
 mint tea 149
 minus 165
 minute 304
 minute hand 304
 minutes 174
 mirror 40, 63, 71, 167

- miscarriage 52
 Miss 23
 missile 211
 mist 287
 miter block 81
 mitt 228
 mittens 30
 mix v 67, 138
 mixed salad 158
 mixing bowl 66, 69
 mixing desk 179
 moat 300
 mobile 74
 model 169, 190
 model making 275
 modeling tool 275
 modem 176
 moisturizer 41
 molar 50
 molding 63
 Moldova 316
 mole 14
 Monaco 316
 Monday 306
 money 97
 Mongolia 318
 monitor 53, 172, 176
 monkey 291
 monkfish 120
 monopoly 272
 monorail 208
 monsoon 287
 month 306
 monthly 307
 monument 261
 Moon 280
 moonstone 288
 moor v 217
 mooring 217
 mop 77
 morning 305
 Morocco 317
 mortar 68, 167, 187
 mortgage 96
 mosque 300
 mosquito 295
 mosquito net 267
 moth 295
 mother 22
 mother-in-law 23
 motor 88
 motor racing 249
 motorbike 204
 motorbike racing 249
 motorcross 249
 motorway 194
 mountain 284
 mountain bike 206
 mountain range 282
 mouse 176, 290
 mousse 141
 mouth 14
 mouth guard 237
 mouthwash 72
 move 273
 movie 260
 movie theater 299
 mow v 90
- Mozambique 317
 mozzarella 142
 MP3 player 268
 Mr. 23
 Mrs. 23
 mudguard 205
 muffin 140
 muffin tray 69
 mug 65
 mulch v 91
 multiply v 165
 multivitamins 109
 mumps 44
 mung beans 131
 muscles 16
 museum 261
 mushroom 125
 music 162
 music school 169
 musical 255
 musical score 255
 musical styles 259
 musician 191
 mussel 121, 295
 mustard 155
 mustard seed 131
 Myanmar 318
- N**
 naan bread 139
 nail 15, 80
 nail clippers 41
 nail file 41
 nail scissors 41
 nail varnish 41
 nail varnish remover 41
 Namibia 317
 nape 13
 napkin 65, 152
 napkin ring 65
 narrow 321
 nation 315
 national park 261
 natural 256
 natural fiber 31
 naturopathy 55
 nausea 44
 navel 12
 navigate v 240
 near 320
 nearsightedness 51
 nebula 280
 neck 12, 258
 neck brace 46
 necklace 36
 neckline 34
 nectarine 126
 needle 109, 276
 needle plate 276
 needle-nose pliers 80
 needlepoint 277
 negative 271
 negative electrode 167
 negligée 35
 neighbor 24
 neoclassical 301
 Nepal 318
 nephew 23
- Neptune 280
 nerve 19, 50
 nervous 19, 25
 net 217, 222, 226, 227, 231
 net v 245
 net curtain 63
 Netherlands 316
 nettle 297
 network 176
 neurology 49
 neutral 60
 neutral zone 224
 new 321
 new moon 280
 new potato 124
 New Year 27
 New Zealand 319
 newborn baby 53
 news 178
 news anchor 179, 191
 newspaper 112
 newsstand 112
 next week 306
 nib 163
 Nicaragua 314
 niece 23
 Niger 317
 Nigeria 317
 night 305
 nightdress 35
 nightie 31
 nightwear 31
 nine 308
 nine hundred 308
 nineteen 308
 nineteen hundred 307
 nineteen hundred and one 307
 nineteen ten 307
 nineteenth 309
 ninetieth 309
 ninety 308
 ninth 309
 nipple 12
 no 322
 no entry 195
 no right turn 195
 no stopping 195
 nonsmoking section 152
 nonstick 69
 noodles 158
 normal 39
 north 312
 North and Central America 314
 North Korea 318
 North pole 283
 North Sea 312
 Northern Hemisphere 283
 Norway 316
 nose 14, 210
 nose clip 238
 noseband 242
 nosebleed 44
 nosewheel 210
 nostril 14
 notation 256
 note 97, 256
- note pad 173
 notebook 163, 172
 notes 175, 191
 notice board 173
 notions 105
 nougat 113
 November 306
 now 304
 nozzle 89
 number 226
 numbers 308
 numerator 165
 nurse 45, 48, 52, 189
 nursery 74
 nursing 53
 nursing bra 53
 nut 80
 nutmeg 132
 nuts 151
 nuts and dried fruit 129
 nylon 277
- O**
 oak 296
 oar 241
 oatmeal 157
 oats 130
 objective lens 167
 oboe 257
 obsidian 288
 obstetrician 52
 occupations 188, 190
 occupied 321
 ocean 282
 ocean liner 215
 octagon 164
 October 306
 octopus 121, 295
 odometer 201
 offal 118
 offers 106
 office 24, 172, 174
 office building 298
 office equipment 172
 office supplies 173
 off-piste 247
 off-side 223
 oil 142, 199
 oil paints 274
 oil tank 204
 oil tanker 215
 oils 134
 oily 41
 ointment 47, 109
 okra 122
 old 321
 olive oil 134
 olives 151
 Oman 318
 omelette 158
 on time 305
 on top of 320
 oncology 49
 one 308
 one billion 309
 one million 309
 one thousand 309
 one-way 194
- one-way system 298
 onion 124
 online 177
 onto 320
 onyx 289
 opal 288
 open 260, 321
 open sandwich 155
 open-top 260
 opera 255
 operating room 48
 operation 48
 operator 99
 ophthalmology 49
 opponent 236
 opposite 320
 optic 150
 optic nerve 51
 optician 51, 189
 orange 126, 274
 orange juice 148
 orangeade 144
 orbit 280
 orchestra 254, 256
 orchestra pit 254
 orchid 111
 order v 153
 oregano 133
 organic 91, 118, 122
 organic waste 61
 origami 275
 ornamental 87
 orthopedics 49
 osteopathy 54
 ostrich 292
 otter 290
 ounce 310
 out 225, 228, 320
 out of bounds 226
 out of focus 271
 outdoor motor 215
 outbuilding 182
 outdoor activities 262
 outer core 282
 outfield 229
 outlet 61
 outpatient 48
 outside 320
 outside lane 194
 out-tray 172
 oval 164
 ovary 20
 oven 66
 oven glove 69
 ovenproof 69
 over 320
 over par 233
 overalls 82
 overdraft 96
 overexposed 271
 overflow pipe 61
 overhead locker 210
 overhead projector 163
 overtake v 195
 overture 256
 ovulation 20, 52
 owl 292
 oyster 121

ozone layer 286

P

Pacific Ocean 312
 pack 311
 pack of cards 273
 packet 311
 packet of cigarettes 112
 pad 224
 paddle 241
 paddling pool 263
 paddock 242
 pads 53, 220
 pajamas 33
 painkiller 47, 109
 paint 83
 paint v 83
 paint tin 83
 paint tray 83
 painter 191
 painting 62, 261, 274
 paints 274
 Pakistan 318
 palate 19
 palette 274
 pallet 186
 palm 15, 86, 296
 palm hearts 122
 palmtop 175
 pan 310
 pan-fried 159
 Panama 314
 pancakes 157
 pancreas 191
 panda 28
 panty liner 108
 papaya 128
 paper clip 173
 paper guide 172
 paper napkin 154
 paper tray 172
 papier-maché 275
 paprika 132
 Papua New Guinea 319
 par 233
 parachute 248
 parachuting 248
 paragliding 248
 Paraguay 315
 parallel 165
 parallel bars 235
 parallelogram 164
 paramedic 94
 parcel 99
 parents 23
 park 262
 park v 195
 parking lot 298
 parking meter 195
 parmesan 142
 parole 181
 parrot 293
 parsley 133
 parsnip 125
 partner 23
 pass 226
 pass v 220, 223
 passenger 216

passenger port 216
 passion fruit 128
 Passover 27
 passport 213
 passport control 213
 pasta 158
 pastels 274
 pasteurized 137
 pasting brush 82
 pasting table 82
 pastry 140, 149
 pastry brush 69
 pasture 182
 patch 207
 patchwork 277
 pâté 142, 156
 path 58, 85
 pathology 49
 patient 45
 patio garden 85
 pattern 276
 pause 269
 pavement 298
 pavement café 148
 paving 85
 pawn 272
 pay v 153
 pay in v 96
 pay per view channel 269
 payment 96
 payroll 175
 peach 126, 128
 peacock 293
 peanut 129, 151
 peanut butter 135
 peanut oil 135
 pear 127
 peas 131
 pecan 129
 pectoral 16
 pectoral fin 294
 pedal 61, 206
 pedal v 207
 pedestrian crossing 195
 pedestrian zone 299
 pediatrics 49
 pedicure 41
 pediment 301
 peel v 67
 peeled prawns 120
 peeler 68
 pelican 292
 pelvis 17
 pen 163, 185
 penalty 222
 penalty area 223
 pencil 163, 275
 pencil case 163
 pencil sharpener 163
 pendant 36
 penpal 24
 penguin 292
 peninsula 282
 penis 21
 pentagon 164
 peony 111
 people 12, 16
 people carrier 199

pepper 64, 124, 152
 peppercorn 132
 pepperoni 142
 percentage 165
 percussion 257
 perennial 86
 perfume 41
 perfumery 105
 pergola 84
 periodical 168
 perm 39
 perpendicular 165
 persimmon 128
 personal best 234
 personal CD player 269
 personal organizer 173, 175
 personal trainer 250
 personnel department 175
 Peru 315
 pesticide 89, 183
 pestle 68, 167
 pet food 107
 pet store 115
 petal 297
 petri dish 166
 pharmacist 108, 189
 pharynx 19
 pheasant 119, 293
 phillips screwdriver 81
 philosophy 169
 Philippines 319
 photo album 271
 photo finish 234
 photo frame 271
 photofit 181
 photographer 191
 photograph 271
 photograph v 271
 photography 270
 physical education 162
 physical therapy 49
 physics 162, 169
 piano 256
 piccolo 257
 pick v 91
 pick and mix 113
 pickax 187
 pickled 159
 pickup 258
 picnic 263
 picnic bench 266
 pie 158
 pie tin 69
 piece 272
 pier 217
 pies 143
 pig 185
 pig farm 183
 pigeon 292
 pigeonhole 100
 piglet 185
 pigsty 185
 pigtailed 39
 Pilates 251
 pill 21, 109
 pillar 300
 pillion 204
 pillow 70

pillowcase 71
 pilot 190, 211
 pin 60, 237, 249, 276
 pin number 96
 pincushion 276
 pine 296
 pine nut 129
 pineapple 128
 pineapple juice 149
 pink 274
 pint 311
 pinto beans 131
 pip 128
 pipe 112, 202
 pipe cutter 81
 pipette 167
 piping bag 69
 pistachio 129
 pita bread 139
 pitch 256, 266
 pitch v 229
 pitch a tent v 266
 pitcher 65, 151, 229
 pitcher's mound 228
 pitches available 266
 pith 126
 pizza 154
 pizza parlor 154
 place mat 64
 place setting 65
 placenta 52
 plain 285
 plain flour 139
 plane 81
 plane v 79
 planet 280, 282
 plant v 183
 plant pot 89
 plants 86, 296
 plaque 50
 plaster 47, 83
 plaster v 82
 plastic bag 122
 plastic pants 30
 plastic surgery 49
 plate 65, 283
 plateau 284
 platform 208
 platform number 208
 platform shoe 37
 platinum 289
 play 254, 269
 play v 229, 273
 player 221, 231, 273
 playground 263
 playhouse 75
 playing 75
 playpen 75
 plea 180
 please 322
 Plimsoll line 214
 plow v 183
 plug 60, 72
 plum 126
 plumb line 82
 plumber 188
 plumbing 61
 plunger 81

plus 165
 Pluto 280
 plywood 79
 pneumatic drill 187
 poach v 67
 poached 159
 pocket 32
 pod 122
 podium 235, 256
 point 273
 poisoning 46
 poker 273
 Poland 316
 polar bear 291
 pole 245, 282
 pole vault 234
 police 94
 police car 94
 police officer 94
 police station 94
 policeman 189
 polish 77
 polish v 77
 politics 169
 polo 243
 polyester 277
 pomegranate 128
 pommel 242
 pommel horse 235
 pond 85
 ponytail 39
 pool 249
 pop 259
 popcorn 255
 poplar 296
 popper 30
 poppy 297
 poppy seeds 138
 porch 58
 porch light 58
 pore 15
 pork 118
 port 145, 176, 214, 216
 porter 100
 portfolio 97
 porthole 214
 portion 74
 portrait 271
 Portugal 316
 positive electrode 167
 post office 98
 postage 98
 postal order 98
 postal worker 98
 postcard 112
 poster 255
 poster paint 274
 postgraduate 169
 postmark 98
 pot plant 110
 pot up v 91
 potato 124
 pot-pourri 111
 potted plant 87
 potter's wheel 275
 pottery 275
 potty 74
 pouch 291

- poultry 119
poultry farm 183
pound 310
pour v 67
powder 77, 109
powder puff 40
powdered milk 137
power 60
power cable 176
power cut 60
practice swing 233
praying mantis 295
pregnancy 52
pregnancy test 52
pregnant 52
premature 52
premolar 50
prenatal 52
prerecorded 178
prescription 45
present 27
presentation 174
presenter 178
preservative 83
preserved fruit 134
press 178
presser foot 276
press-up 251
pressure valve 61
price 152, 199
price list 154
prickly pear 128
primer 83
primrose 297
principal 163
principality 315
print 271
print v 172
printer 172, 176
printing 275
prison 181
prison guard 181
private bathroom 100
private jet 211
private room 48
probe 50
problems 271
processed grains 130
procession 27
processor 176
producer 254
program (computer) 176
program 254, 269
programming 178
projector 174
promenade 265
propagate v 91
propeller 211, 214
proposal 174
prosciutto 143
prosecution 180
prostate 21
protractor 165
proud 25
prove v 139
province 315
prow 215
prune 129
prune v 91
pruners 89
psychiatry 49
psychotherapy 55
public address system 209
puck 224
Puerto Rico 314
puff pastry 140
pull up v 251
pulp 127
pulse 47
pumice 288
pumice stone 73
pump 207
pumpkin 125
pumpkin seed 131
punch 237
punch bag 237
puncture 203, 207
pup 290
pupil 51, 162
puppy 290
purple 274
purse 37
pushpin 173
putt v 233
putter 233
pyramid 164
- Q**
Qatar 318
quadriceps 16
quail 119
quail egg 137
quart 311
quarter of an hour 304
quarterdeck 214
quartz 289
quay 216
queen 272, 273
question 163
question v 163
quilt 71
quilting 277
quince 128
quinoa 130
quiver 249
- R**
rabbit 118, 290
raccoon 290
race 234
racecourse 243
racehorse 243
racing bike 205, 206
racing dive 239
racing driver 249
rack 166
racquet 230
racquet games 231
racquetball 231
radar 214, 281
radiator 60, 202
radicchio 123
radio 179, 268
radio antenna 214
radio station 179
radiology 49
radish 124
radius 17, 164
rafter 186
rafting 241
rail 208
rail network 209
rain 287
rain boots 31
rainbow 287
rainbow trout 120
raincoat 31, 32
rain forest 285
raisin 129
rake 88
rake v 90
rally 230
rally driving 249
RAM 176
Ramadan 26
ramekin 69
rap 259
rapeseed 184
rapeseed oil 135
rapids 240, 284
rash 44
rasher 119
raspberry 127
raspberry jam 134
rat 290
rattle 74
raw 124, 129
ray 294
razor blade 73
razor-shell 121
read v 162
reading light 210
reading list 168
reading room 168
real estate agent 189
real estate agency 115
reamer 80
rear light 207
rear wheel 197
rearview mirror 198
receipt 152
receive v 177
receiver 99
reception 100
receptionist 100, 190
rechargeable drill 78
record 234, 269
record player 268
record shop 115
recording studio 179
rectangle 164
rectum 21
recycling bin 61
red 145, 274
red card 223
red eye 271
red kidney beans 131
red lentils 131
red meat 118
red mullet 120
Red Sea 313
reduce v 172
reel 244
reel in v 245
refectory 168
referee 222, 226
referral 49
reflector 50, 204, 207
reflector strap 205
reflexology 54
refrigerator 67
refrigerator-freezer 67
reggae 259
region 315
register 100
registered mail 98
regulator 239
reheat v 154
reiki 55
reins 242
relationships 24
RAM 176
relatives 23
relaxation 55
relay race 235
release v 245
remote control 269
Renaissance 301
renew v 168
rent 58
rent v 58
repair kit 207
report 174
reporter 179
reproduction 20
reproductive 19
reproductive organs 20
reptiles 293
research 169
reserve v 168
residence hall 168
respiratory 19
rest 256
restaurant 101, 152
result 49
resurfacing 187
resuscitation 47
retina 51
retire v 26
return 231
return address 98
return date 168
rev counter 201
reverse v 195
rewind 269
rhinoceros 291
rhombus 164
rhubarb 127
rhythmic gymnastics 235
rib 17, 119
ribcage 17
ribbon 27
ribbon 39, 111, 141, 235
ribs 155
rice 130, 158, 184
rice ball 154
rice bowl 64
rice pudding 140
rice vinegar 135
rice wine 152
rider 242
riding boot 242
riding crop 242
riding hat 242
rigging 215, 240
right 260
right field 229
right-hand drive 201
rim 206
rind 119, 127, 136, 142
ring 36
ring finger 15
ring ties 89
rings 235
rinse v 38, 76
ripe 129
rise v 139
river 284
road bike 206
road markings 194
road signs 195
roads 194
roadworks 187, 195
roast 158
roast v 67
roasted 129
robe 38, 169
rock climbing 248
rock concert 258
rock garden 84
rocks 284, 288
Rocky Mountains 312
rococo 301
rodeo 243
roll 139, 311
roll v 67
roller 83, 187
roller blind 63
roller coaster 262
roller skating 249
rollerblading 263
rollerskate 249
rolling pin 69
romance 255
Romania 316
romper suit 30
roof 58, 203
roof garden 84
roof tile 187
roofrack 198
rook 272
room 58
room key 100
room number 100
room service 101
rooms 100
root 50, 124, 296
roots 39
rope 248
rose 89, 110, 145
rosé 145
rosemary 133
rotor blade 211
rotten 127
rough 232
round 237
round neck 33
route number 196
router 78
row 210, 254
row v 241

- rower 241
 rowing boat 214
 rowing machine 250
 rubber 163
 rubber band 173
 rubber boots 89
 rubber ring 265
 rubber stamp 173
 ruby 288
 ruck 221
 rudder 210, 241
 rug 63
 rugby 221
 rugby field 221
 rugby uniform 221
 ruler 163, 165
 rum 145
 rum and coke 151
 rump steak 119
 run 228
 run v 228
 runner bean 122
 runway 212
 rush 86
 Russian Federation 318
 Rwanda 317
 rye bread 138
- S**
 sad 25
 saddle 206, 242
 safari park 262
 safe 228
 safety 75, 240
 safety barrier 246
 safety goggles 81, 167
 safety pin 47
 saffron 132
 sage 133
 Sahara Desert 313
 sail 241
 sailboat 215
 sailing 240
 sailor 189
 salad 149
 salamander 294
 salami 142
 salary 175
 sales assistant 104
 sales department 175
 salmon 120
 saloon 199
 salt 64, 152
 salted 121, 129, 137, 143
 San Marino 316
 sand 85, 264
 sand v 82
 sandal 37
 sandals 31
 sandcastle 265
 sander 78
 sandpaper 81, 83
 sandpit 263
 sandstone 288
 sandwich 155
 sandwich counter 143
 sanitary towel 108
 São Tomé and Príncipe 317
- sapphire 288
 sardine 120
 Sardinia 316
 sashimi 121
 satellite 281
 satellite dish 269
 satellite navigation 201
 satsuma 126
 Saturday 306
 Saturn 280
 sauce 134, 143, 155
 saucepan 69
 Saudi Arabia 318
 sauna 250
 sausage 155, 157
 sausages 118
 sauté v 67
 save v 177, 223
 savings 96
 savings account 97
 savoury 155
 saw v 79
 saxophone 257
 scaffolding 186
 scale 121, 256, 294
 scales 45, 53, 69, 98, 118, 166, 212, 293, 310
 scallop 121
 scalp 39
 scalpel 81, 167
 scan 48, 52
 scanner 106, 176
 scarecrow 184
 scared 25
 scarf 31, 36
 schist 288
 scholarship 169
 school 162, 299
 school bag 162
 school bus 196
 school uniform 162
 schoolboy 162
 schoolgirl 162
 schools 169
 science 162, 166
 science fiction film 255
 scientist 190
 scissors 38, 47, 82, 188, 276
 scoop 68, 149
 scooter 205
 score 220, 256, 273
 score a goal v 223
 scoreboard 225
 scorpion 295
 scotch and water 151
 scrabble 272
 scrambled eggs 157
 scrape v 77
 scraper 82
 screen 59, 63, 97, 176, 255, 269
 screen wash 199
 screen wash reservoir 202
 screw 80
 screwdriver 80
 screwdriver bits 80
 script 254
 scrollbar 177
- scrotum 21
 scrub v 77
 scrum 221
 scuba diving 239
 sculpting 275
 sculptor 191
 sea 264, 282
 sea bass 120
 sea bream 120
 sea horse 294
 sea lion 290
 sea plane 211
 seafood 121
 seal 290
 sealant 83
 sealed jar 135
 seam 34
 seamstress 191
 search v 177
 seasonal 129
 seasons 306
 seat 61, 204, 209, 210, 242, 254
 seat back 210
 seat belt 198, 211
 seat post 206
 seating 254
 second 304, 309
 second floor 104
 second hand 304
 second-hand shop 115
 section 282
 security 212
 security bit 80
 security guard 189
 sedative 109
 sedimentary 288
 seed 122, 127, 130
 seed tray 89
 seeded bread 139
 seedless 127
 seedling 91
 seeds 88, 131
 seesaw 263
 segment 126
 self defence 237
 self-raising flour 139
 self-tanning cream 41
 semidetached 58
 semi-hard cheese 136
 seminal vesicle 21
 semi-skimmed milk 136
 semi-soft cheese 136
 semolina 130
 send v 177
 send off 223
 Senegal 317
 sensitive 41
 sentence 181
 September 306
 serve 231
 serve v 64, 231
 server 176
 service included 152
 service line 230
 service not included 152
 service provider 177
 service vehicle 212
- sesame seed 68
 sesame seed oil 134
 set 178, 230, 254
 set v 38
 set honey 134
 set sail v 217
 set square 165
 set the alarm v 71
 seven 308
 seven hundred 308
 seventeen 308
 seventeenth 309
 seventh 309
 seventieth 309
 seventy 308
 sew v 277
 sewing basket 276
 sewing machine 276
 sexually transmitted disease 20
 shade 41
 shade plant 87
 shallot 125
 shallow end 239
 shampoo 38
 shapes 164
 share price 97
 shares 97
 shark 294
 sharp 256
 sharpening stone 81
 shaving 73
 shaving foam 73
 shears 89
 shed 84
 sheep 185
 sheep farm 183
 sheep's milk 137
 sheet 71, 74, 241
 shelf 67, 106
 shell 129, 137, 265, 293
 shelled 129
 shelves 66
 sherry 145
 shiatsu 54
 shield 88
 shin 12
 ship 214
 ships 215
 shipyard 217
 shirt 32
 shitake mushrooms 124
 shock 47
 shocked 25
 shoe department 104
 shoe store 114
 shoes 34, 37
 shoot v 223, 227
 shopping 104
 shopping bag 106
 shopping center 104
 short 32, 321
 short wave 179
 short-grain 130
 shorts 30, 33
 shot 151
 shotput 234
- shoulder 13
 shoulder bag 37
 shoulder blade 17
 shoulder pad 35
 shoulder strap 37
 shout v 25
 shovel 187
 shower 72
 shower block 266
 shower curtain 72
 shower door 72
 shower gel 73
 shower head 72
 showjumping 243
 shuffle v 273
 shutoff valve 61
 shutter 58
 shutter release 270
 shutter-speed dial 270
 shuttle bus 197
 shuttlecock 231
 shy 25
 Siberia 313
 Sicily 316
 side 164
 sideline 220
 side order 153
 side plate 65
 side saddle 242
 side street 299
 sidedeck 240
 side-effects 109
 sideline 226, 230
 Sierra Leone 317
 sieve 68, 89
 sieve v 91
 sift v 138
 sigh v 25
 sightseeing 260
 sign 104
 signal 209
 signature 96, 98
 silencer 203, 204
 silk 277
 silo 183
 silt 85
 silver 235, 289
 simmer v 67
 Singapore 319
 singer 191
 single 151
 single bed 71
 single cream 137
 single room 100
 singles 230
 sink 38, 61, 66
 sinus 19
 siren 94
 sirloin steak 119
 sister 22
 sister-in-law 23
 site manager's office 266
 sit-up 251
 six 308
 six hundred 308
 sixteen 308
 sixteenth 309

- sixth 309
 sixtieth 309
 sixty 308
 skate 120, 247, 294
 skate v 224
 skate wings 120
 skateboard 249
 skateboarding 249, 263
 skein 277
 skeleton 17
 sketch 275
 sketch pad 275
 skewer 68
 ski 241, 246
 ski boot 246
 ski jump 247
 ski pole 246
 ski run 246
 ski slope 246
 ski suit 246
 skier 246
 skiing 246
 skin 14, 119, 128
 skin care 108
 skinned 121
 skipping 251
 skirt 30, 34
 skull 17
 skydiving 248
 skyscraper 299, 300
 slalom 247
 slate 288
 sledding 247
 sledgehammer 187
 sleeper 30
 sleeping 74
 sleeping bag 267
 sleeping compartment 209
 sleeping mat 267
 sleeping pill 109
 sleet 286
 sleeve 34
 sleeveless 34
 slice 119, 139, 140, 230
 slice v 67
 sliced bread 138
 slicer 139
 slide 167, 263
 slide v 229
 sling 46
 slip 35
 slip road 194
 slip-on 37
 slippers 31
 slope 284
 slotted spoon 68
 Slovakia 316
 Slovenia 316
 slow 321
 slug 295
 small 321
 small car 199
 small intestine 18
 small of back 13
 smash 231
 smile 25
 smoke 95
 smoke alarm 95
 smoked 118, 121, 143, 159
 smoked fish 143
 smoking 112
 smoking section 152
 snack bar 113, 148
 snail 295
 snake 293
 snare drum 257
 sneeze 44
 snooker 249
 snore v 71
 snorkel 239
 snout 293
 snow 287
 snowboarding 247
 snowmobile 247
 snowsuit 30
 soak v 130
 soap 73, 178
 soap dish 73
 soccer 222
 soccer player 222
 soccer uniform 31, 222
 socket 60, 80
 socket wrench 80
 socks 33
 soda bread 139
 soda water 144
 sofa 62
 sofabed 63
 soft 129, 321
 soft cheese 136
 soft drink 154
 soft drinks 144
 soft toy 75
 software 176
 softwood 79
 soil 85
 solar system 280
 solder 79, 80
 solder v 79
 soldering iron 81
 soldier 189
 sole 15, 37
 solids 164
 Solomon Islands 319
 soluble 109
 solvent 83
 Somalia 317
 somersault 235
 son 22
 sonata 256
 song 259
 son-in-law 22
 sorbet 141
 sorrel 123
 sorting unit 61
 soufflé 158
 soufflé dish 69
 sound boom 179
 sound technician 179
 soundtrack 255
 soup 153, 158
 soup bowl 65
 soup spoon 65
 sour 127
 sour cream 137
 sourdough bread 139
 south 312
 South Africa 317
 South Korea 318
 Southern Hemisphere 283
 Southern Ocean 313
 souvenirs 260
 sow v 90, 183
 soybeans 131
 soy sauce 135
 space 280
 space exploration 281
 space shuttle 281
 space station 281
 space suit 281
 spade 88, 265, 273
 Spain 316
 spanner 80
 spare tire 203
 spark plug 203
 sparkling 144
 sparring 237
 sparrow 292
 spatula 68, 167
 speaker 174, 176, 258, 268
 speaker stand 268
 spearfishing 245
 specials 152
 spectators 233
 speed boating 241
 speed limit 195
 speed skating 247
 speedboat 214
 speedometer 201, 204
 spell v 162
 sperm 20
 sphere 164
 spices 132
 spicy sausage 142
 spider 295
 spike v 90
 spikes 233
 spin 230
 spin v 76
 spin dryer 76
 spinach 123
 spine 17
 spire 300
 spirit level 80, 187
 splashback 66
 spleen 18
 splint 47
 splinter 46
 split ends 39
 split peas 131
 spoke 207
 sponge 73, 74, 83
 sponge cake 140
 sponge fingers 141
 spool 245
 spoon 65
 sport fishing 245
 sports 105, 220, 236, 248
 sports car 198
 sports field 168
 sports jacket 33
 sportsman 191
 spotlight 259
 sprain 46
 spray 109
 spray v 91
 spray can 311
 spray gun 89
 spring 71, 307
 spring balance 166
 spring greens 123
 springboard 235, 238
 sprinkler 89
 sprinter 234
 sprocket 207
 square 164, 272, 299
 square foot 310
 square meter 310
 squash 231
 squat 251
 squid 121, 295
 squirrel 290
 Sri Lanka 318
 St. Kitts and Nevis 314
 St. Lucia 314
 St. Vincent and the
 Grenadines 314
 stabilisers 207
 stable 185, 243
 stadium 223
 staff 175, 256
 stage 167, 254
 stages 23
 stainless steel 79
 stair gate 75
 staircase 59
 stake 90
 stake v 91
 stalk 122, 297
 stalls 254
 stamen 297
 stamp 98
 stamp collecting 273
 stamps 112
 stance 232
 stand 88, 205, 268
 stapler 173
 staples 173
 star 280
 star anise 133
 starfish 295
 starfruit 128
 start school v 26
 starter 153
 starting block 234, 238
 starting line 234
 state 315
 statement 180
 stationery 105
 station wagon 199
 statuette 260
 steak 121
 steam v 67
 steam train 208
 steamed 159
 steplechase 243
 steering wheel 201
 steel wool 81
 stem 111, 112, 297
 stencil 83
 stenographer 181
 step machine 250
 stepdaughter 23
 stepfather 23
 stepladder 82
 stepmother 23
 stepson 23
 stereo 269
 sterile 47
 stern 240
 stethoscope 45
 stew 158
 stick 224, 249
 sticks 133
 sticky tape 173
 still 144
 sting 46, 295
 stir v 67
 stirrer 150
 stirrup 242
 stitch 277
 stitch selector 276
 stitches 52
 stock broker 97
 stock exchange 97
 stockings 35
 stocks 97, 110
 stomach 18
 stomach ache 44
 stone 36, 275
 stoned fruit 126
 stop 269
 stop button 197
 stopper 166
 stopwatch 234
 store 114, 298
 store assistant 188
 store directory 104
 stork 292
 storm 287
 stout 145
 stovetop 67
 straight 39, 165
 straight on 260
 straighten v 39
 strap 35
 strapless 34
 stratosphere 286
 straw 144, 154
 strawberry 127
 strawberry milkshake 149
 stream 285
 street 298
 street corner 98
 street light 298
 street sign 298
 street stall 154
 stress 55
 stretch 251
 stretcher 94
 strike 228, 237
 string 230, 258
 string of pearls 36
 strings 256
 strip v 82
 stroke 44, 233, 239
 strokes 231
 stroller 75
 strong 321
 strong flour 139

- stub 96
 study 63, 162
 stuffed 159
 stuffed olive 143
 stump 225
 styles 39, 239, 301
 submarine 215
 subsoil 91
 substitute 223
 substitution 223
 subtract v 165
 suburb 299
 succulent 87
 suction hose 77
 Sudan 317
 sugarcane 184
 suit 273
 sulfur 289
 sultana 129
 summer 31, 307
 summons 180
 sumo wrestling 237
 Sun 280
 sunbathe v 264
 sunbed 41
 sunblock 108, 265
 sunburn 46
 Sunday 306
 sunflower 184, 297
 sunflower oil 134
 sunflower seed 131
 sunglasses 51, 265
 sunhat 30, 265
 sunny 286
 sunrise 305
 sunroof 202
 sunscreen 108
 sunset 305
 sunshine 286
 suntan lotion 265
 supermarket 106
 supersonic jet 211
 supplement 55
 supply pipe 61
 support 187
 suppository 109
 surf 241
 surfboard 241
 surfcasting 245
 surfer 241
 surfing 241
 surgeon 48
 surgery 45, 48
 Suriname 315
 surprised 25
 sushi 121
 suspect 94, 181
 suspenders 35
 suspension 203, 205
 swallow 292
 swamp 285
 swan 293
 Swaziland 317
 sweater 33
 sweatpants 33
 sweatshirt 33
 rutabaga 125
 Sweden 316
- sweep v 77
 sweet 124, 127, 155
 sweet potato 125
 sweet shop 113
 sweet spreads 134
 sweet cart 152
 swim v 238
 swimmer 238
 swimming 238
 swimming pool 101, 238,
 250
 swimsuit 238, 265
 swing v 232
 swings 263
 swiss chard 123
 switch 60
 Switzerland 316
 swivel chair 172
 sword 236
 swordfish 120, 294
 symphony 256
 synagogue 300
 synchronized swimming 239
 synthetic fiber 31
 Syria 318
 syringe 109, 167
 syrup 109
 system 176
- T**
 tab 173
 table 64, 148
 table tennis 231
 tablecloth 64
 tack v 241, 277
 tackle 245
 tackle v 220, 223
 tackle box 244
 tadpole 294
 tae-kwon-do 236
 tag v 229
 tai chi 236
 tail 121, 210, 242, 280, 290,
 294
 tail light 204
 tailbone 17
 tailgate 198
 tailor 191
 tailored 35
 tailor's 115
 tailor's chalk 276
 tailor's dummy 276
 tailplane 210
 Tajikistan 318
 take a bath v 72
 take a shower v 72
 take notes v 163
 take off v 211
 take-out 154
 talcum powder 73
 tall 321
 tamarillo 128
 tambourine 257
 tampon 108
 tan 41
 tandem 206
 tangerine 126
 tank 61
- Tanzania 317
 tap water 144
 tape dispenser 173
 tape measure 80, 276
 target 249
 target shooting 249
 tarmac 187
 taro root 124
 tarragon 133
 Tasmania 319
 tattoo 41
 tax 96
 taxi driver 190
 taxi rank 213
 tea 144, 149, 184
 tea with lemon 149
 tea with milk 149
 teabag 144
 teacher 54, 162, 191
 teacup 65
 team 220, 229
 teapot 65
 tear 51
 teaspoon 65
 teat 75
 techniques 79, 159
 teddy bear 75
 tee 233
 teeing ground 232
 teenager 23
 tee-off v 233
 telegram 98
 telephone 99, 172
 telephone box 99
 telescope 281
 television series 178
 television studio 178
 temperature 286
 temperature gauge 201
 temple 14, 300
 ten 308
 ten thousand 309
 tenant 58
 tend v 91
 tendon 17
 tennis 230
 tennis court 230
 tennis shoes 231
 tenon saw 81
 tent 267
 tent peg 266
 tent pole 266
 tenth 309
 tequila 145
 terminal 212
 termite 295
 terrace café 148
 terraced 58
 territory 315
 terry diaper 30
 test 49
 testis 21
 test tube 166
 text message 99
 textbook 163
 Thailand 318
 thank you 322
 Thanksgiving 27
- the day after tomorrow 307
 the day before yesterday 307
 theater 254, 299
 theme park 262
 therapist 55
 thermals 267
 thermometer 45, 167
 thermosphere 286
 thermostat 61
 thesis 169
 thick 321
 thigh 12, 119
 thimble 276
 thin 321
 third 309
 thirteen 308
 thirteenth 309
 thirtieth 309
 thirty 308
 this way up 98
 this week 307
 thistle 297
 thoracic vertebrae 17
 thread 276
 thread v 277
 thread guide 276
 thread reel 276
 three 308
 three hundred 308
 three-door 200
 three-point line 226
 thriller 255
 throat 19
 throat lozenge 109
 throttle 204
 through 320
 throw 237
 throw v 221, 227, 229
 throw-in 223, 226
 thruster 281
 thumb 15
 thunder 286
 Thursday 306
 thyme 133
 thyroid gland 18
 tibia 17
 ticket 209, 213
 ticket barrier 209
 ticket inspector 209
 ticket office 209, 216
 tie 32
 tiebreak 230
 tie-pin 36
 tiger 291
 tights 35, 251
 tile 58, 272
 tile v 82
 till 106, 150
 tiller 240
 timber 187
 time 234, 304
 time out 220
 timer 166
 times 165, 261
 timetable 197, 209, 261
 timing 203
 tip 36, 122, 246
 tire 198, 205, 206
- tire lever 207
 tire pressure 203
 tissue 108
 title 168
 titles 23
 to 320
 toad 294
 toast 157
 toasted sandwich 149
 toaster 66
 tobacco 112, 184
 today 306
 toddler 30
 toe 15
 toe clip 207
 toe strap 207
 toenail 15
 toffee 113
 toggle 31
 Togo 317
 toilet 72
 toilet brush 72
 toilet roll 72
 toilet seat 72
 toiletries 41, 107
 toilets 104, 266
 toll booth 194
 tomato 125, 157
 tomato juice 144, 149
 tomato sauce 154
 tomorrow 306
 toner 41
 tongs 150, 167
 tongue 19, 37, 118
 tonic water 144
 tonne 310
 tool rack 78
 toolbar 177
 toolbelt 186
 toolbox 80
 tools 187
 tooth 50
 toothache 50
 toothbrush 72
 toothpaste 72
 top coat 83
 top dress v 90
 top tier 141
 topaz 288
 topiary 87
 topping 155
 topsoil 85
 tornado 287
 tortoise 293
 touch line 221
 touchdown 221
 tour bus 260
 tour guide 260
 tourer 205
 touring bike 206
 tourist 260
 tourist attraction 260
 tourist bus 197
 tourist information 261
 tourmaline 288
 tournament 233
 tow away v 195
 tow truck 203

- toward 320
towel rail 72
towels 73
tower 300
town 298
town hall 299
townhouse 58
toy 75
toy basket 75
toys 105
track 208, 234
track & field 234
tracksuit 31, 32
tractor 182
traffic 194
traffic circle 195
traffic jam 195
traffic light 194
traffic policeman 195
trailer 266
train 35, 208
train v 91, 251
train station 208
trainer 37
trainers 31, 251
tram 196, 208
transfer 223
transformer 60
transmission 202
transplant v 91
transport 194
trapezium 164
trapezius 16
trash 177
trash bin 61, 67
travel agent 190
travel agent's 114
travel sickness pills 109
traveler's check 97
tray 152, 154
tray-table 210
tread 207
tread water v 239
treadmill 250
treble clef 256
tree 86, 296
trekking 243
trellis 84
tremor 283
triangle 164, 257
triceps 16
trifle 141
trim v 39, 90
trimester 52
trimmer 88
Trinidad and Tobago 314
tripod 166, 270, 281
trolley bus 196
trombone 257
Tropic of Cancer 283
Tropic of Capricorn 283
tropical fruit 128
tropics 283
troposphere 286
trot 243
trough 183
trousers 32, 34
trout 120
trowel 89, 187
truffle 113, 125
trug 88
trumpet 257
truncheon 94
trunk 291, 296
trunks 238
try 221
t-shirt 30, 33
tub 311
tuba 257
tube 311
Tuesday 306
tug boat 215
tulip 111
tumble 235
tumble dryer 76
tumbler 65
tuna 120
tune v 179
tune the radio v 269
tuning peg 258
Tunisia 317
turbocharger 203
turf v 90
Turkey 318
turkey 119, 185, 293
Turkmenistan 318
turmeric 132
turn 238
turn v 79
turn the television off v 269
turn the television on v 269
turnip 124
turpentine 83
turquoise 289
turret 300
turtle 293
tusk 291
tutu 191
tweezers 40, 47, 167
twelfth 309
twelve 308
twentieth 309
twenty 308
twenty minutes 304
twenty thousand 309
twenty-first 309
twenty-one 308
twenty-second 309
twenty-third 309
twenty-two 308
twig 296
twin room 100
twine 89
twins 23
twist ties 89
two 308
two hundred 308
two o'clock 304
two thousand 307
two thousand and one 307
two-door 200
types 199, 205
types of buses 196
types of camera 270
types of farm 183
types of plants 86
types of fishing 245
types of trains 208
typhoon 286
- U**
Uganda 317
ugli 126
Ukraine 316
ulna 17
ultrasound 52
ultraviolet rays 286
umbilical cord 52
umbrella 36, 233
umpire 225, 229, 230
uncle 22
unconscious 47
uncooked meat 142
under 320
under par 233
undercoat 83
underexposed 271
undergraduate 169
underground map 209
underground train 209
underpass 194
underwear 32, 35
underwired 35
uniform 94, 189
United Arab Emirates 318
United Kingdom 316
United States of America 314
universe 280
university 299
unleaded 199
unpasteurized 137
unpick v 277
unsalted 137
until 320
up 320
upper circle 254
upset 25
Uranus 280
ureter 21
urethra 20
urinary 19
urology 49
Uruguay 315
usher 255
utensils 64
uterus 20, 52
utility room 76
Uzbekistan 318
- V**
vacuum cleaner 77, 188
vacuum flask 267
vagina 20
valance 71
valley 284
valve 207
vanilla 132
Vanuatu 319
varnish 79, 83
vas deferens 21
vase 63, 111
Vatican City 316
vault 235, 300
veal 118
vegetable garden 85
vegetable oil 135
vegetable plot 182
vegetables 107, 122, 124
veggie burger 155
veil 35
vein 19
venetian blind 63
Venezuela 315
venison 118
vent 283
ventouse cup 53
Venus 280
verdict 181
vest 33, 35, 251
vet 189
vibraphone 257
vice 78
video game 269
video phone 99
video recorder 269
video tape 269
Viet Nam 318
viewfinder 271
village 299
vine 183
vinegar 135, 142
vineyard 183
vintage 199
viola 256
violin 256
virus 44
visa 213
vision 51
visiting hours 48
visor 205
vitamins 108
v-neck 33
vocal cords 19
vodka 145
vodka and orange 151
voice message 99
volcano 283
volley 231
volleyball 227
voltage 60
volume 165, 179, 269, 311
vomit v 44
- W**
waders 244
waffles 157
waist 12
waistband 35
waistcoat 33
waiter 148, 152
waiting room 45
waitress 191
wake up v 71
walk 243
walking boot 37, 267
walkway 212
wall 58, 186, 222
wall light 62
wallet 37
wallpaper 82, 177
wallpaper v 82
wallpaper brush 82
wallpaper paste 82
walnut 129
walnut oil 134
walrus 290
ward 40
wardrobe 70
warehouse 216
warm 286
warm up v 251
warrant 180
wash v 38, 77
washbasin 72
washer 80
washer-dryer 76
washing machine 76
wasp 295
waste disposal 61, 266
waste disposal unit 61
waste pipe 61
wastebasket 172
watch 36
watch television v 269
water 144, 238
water v 90, 183
water bottle 206, 267
water chamber 61
water chestnut 124
water closet 61
water garden 84
water hazard 232
water jet 95
water plant 86
water polo 239
watercolor paints 274
watercress 123
waterfall 285
watering 89
watering can 89
watermelon 127
waterproofs 245, 267
waterskier 241
waterskiing 241
watersports 241
wave 241, 264
wavelength 179
wax 41
weak 321
weather 286
weaving 277
website 177
wedding 26, 35
wedding cake 141
wedding dress 35
wedding reception 26
wedge 233
Wednesday 306
weed v 91
weed killer 91
weeds 86
week 306
weekend 306
weekly 307
weigh v 310
weight 166, 244
weight bar 251
weight belt 239
weight training 251
west 312

western 255
 Western Sahara 317
 wet 286, 321
 wet wipe 75, 108
 wetsuit 239
 whale 290
 wheat 130, 184
 wheel 198, 207
 wheel nuts 203
 wheelbarrow 88
 wheelchair 48
 wheelchair access 197
 whiplash 46
 whipped cream 137
 whisk 68
 whisk v 67
 whiskers 290
 whisky 145
 white 39, 145, 272, 274
 white bread 139
 white chocolate 113
 white coffee 148
 whitecurrant 127
 white flour 138
 white meat 118
 white rice 130
 white spirit 83
 whiting 120
 whole 129, 132
 whole milk 136
 wholegrain 131
 wholegrain flour 138
 wholegrain mustard 135
 wholemeal bread 139
 wicket 225
 wicket-keeper 225
 wide 321
 widescreen television 269
 width 165
 wife 22
 wig 39
 wild rice 130
 willow 296
 win v 273
 wind 241, 286
 windbreak 265
 windcheater 33
 windlass 214
 window 58, 96, 98, 177, 186,
 197, 209, 210
 windpipe 18
 windscreen 198
 windscreen wiper 198
 windshield 205
 windsurfer 241
 windsurfing 241
 windy 286
 wine 145, 151
 wine glass 65
 wine list 152
 wine vinegar 135
 wing 119, 210, 293
 wing mirror 198
 wings 254
 winner 273
 winter 31, 307
 winter sports 247
 wipe v 77

wire 79
 wire cutter 80
 wire strippers 81
 wires 60
 with 320
 withdrawal slip 96
 without 320
 witness 180
 wok 69
 wolf 290
 woman 23
 womb 52
 women's clothing 34
 women's wear 105
 wood 79, 233, 275, 285
 wood glue 78
 wood shavings 78
 wooden spoon 68
 woodpecker 292
 woodstain 79
 woodwind 257
 woodworking 275
 wool 277
 work 172
 work day 306
 workbench 78
 workshop 78
 worktop 66
 world map 312
 worm 295
 worried 25
 wound 46
 wrap 155
 wrapping 111
 wreath 111
 wrench 81, 203
 wrestling 236
 wrinkle 15
 wrist 13, 15
 wristband 230
 writ 180
 write v 162

X

x-ray 48
 x-ray film 50
 x-ray machine 212
 x-ray viewer 45

Y

yacht 215, 240
 yam 125
 yard 310
 yawn v 25
 year 163, 306
 yeast 138
 yellow 274
 yellow card 223
 Yemen 318
 yes 322
 yesterday 306
 yoga 54
 yogurt 137
 yolk 137, 157
 you're welcome 322
 Yugoslavia 316

Z

Zambia 317
 zebra 291
 zero 308
 zest 126
 Zimbabwe 317
 zinc 289
 ZIP code 98
 zipper 277
 zone 315
 zones 283
 zoo 262
 zoology 169
 zoom lens 270
 zucchini 125

謝辭 shaji • acknowledgments

DORLING KINDERSLEY would like to thank Tracey Miles and Christine Lacey for design assistance, Georgina Garner for editorial and administrative help, Sonia Gavira, Polly Boyd, and Cathy Meeus for editorial help, and Claire Bowers for compiling the DK picture credits.

The publisher would like to thank the following for their kind permission to reproduce their photographs:

Abbreviations key:

t=top, b=bottom, r=right, l=left, c=center

Abode: 62; **Action Plus:** 224bc; **alamy.com:** 154t; A.T. Willett 287bcl; Michael Foyle 184bl; Stock Connection 287bcr; **Allsport/Getty Images:** 238cl; **Alvey and Towers:** 209 acr, 215bcl, 215bcr, 241cr; **Peter Anderson:** 188cbr, 271br. **Anthony Blake Photo Library:** Charlie Stebbings 114cl; John Sims 114tcl; **Andyalte:** 98tl; **apple mac computers:** 268tcr; **Arcaid:** John Edward Linden 301bl; Martine Hamilton Knight, Architects: Chapman Taylor Partners, 213cl; Richard Bryant 301br; **Argos:** 41tcl, 66cbl, 66cl, 66br, 66bcl, 69cl, 70bcl, 71t, 77tl, 269tc, 270tl; **Axiom:** Eitan Simanor 105bcr; Ian Cumming 104; Vicki Couchman 148cr; **Beken Of Cowes Ltd:** 215cbc; **Bosch:** 76tcr, 76tc, 76tcl; **Camera Press:** 27c, 38r, 256t, 257cr; Barry J. Holmes 148tr; Jane Hanger 159cr; Mary Germanou 259bc; **Corbis:** 78b; Anna Clopet 247tr; Bettmann 181tl, 181tr; Bo Zauders 156t; Bob Rowan 152bl; Bob Winsett 247cbl; Brian Bailey 247br; Carl and Ann Purcell 162l; Chris Rainer 247ct; ChromoSohm Inc. 179tr; Craig Aurness 215bl; David H.Wells 249cbr; Dennis Marsico 274bl; Dimitri Lundt 236bc; Duomo 211tl; Gail Mooney 277ctcr; George Lepp 248c; Gunter Marx 248cr; Jack Fields 210b; Jack Hollingsworth 231bl; Jacqui Hurst 277cbr; James L. Amos 247bl, 191ctr, 220bcr; Jan Butchofsky 277cbc; Johnathan Blair 243cr; Jon Feingersh 153tr; Jose F. Poblete 191br; Jose Luis Pelaez.Inc 153tc, 175tl; Karl Weatherly 220bl, 247tcr; Kelly Mooney Photography 259tl; Kevin Fleming 249bc; Kevin R. Morris 105tr, 243tl, 243tc; Kim Sayer 249tcr; Lynn Goldsmith 258t; Macduff Everton 231bcl; Mark Gibson 249bl; Mark L. Stephenson 249tcl; Michael Pole 115tr; Michael S. Yamashita 247ctcl; Mike King 247cbl; Neil Rabinowitz 214br; Owen Franken 112t; Pablo Corral 115bc; Paul A. Sounders 169br, 249ctcl;

Paul J. Sutton 224c, 224br; Peter Turnley 105tcr; Phil Schermeister 27b, 248tr; R. W. Jones 309; R.W. Jones 175tr; Richard Hutchings 168b; Rick Doyle 241ctr; Robert Holmes 97br, 277ctc; Roger Ressimeyer 169tr; Russ Schleipman 229; Steve Raymer 168cr; The Purcell Team 211ctr; Tim Wright 178; Vince Streano 194t; Wally McNamee 220br, 220bcl, 224bl; Yann Arhous-Bertrand 249tl; **Demetrio Carrasco / Dorling Kindersley (c) Herge / Les Editions Casterman:** 112ccl; **Dixons:** 270cl, 270cr, 270bl, 270bcl, 270bcr, 270ccr; **Education Photos:** John Walmsley 26tl; **Empics Ltd:** Adam Day 236br; Andy Heading 243c; Steve White 249cbc; **Getty Images:** 48bcl, 100t, 114bcr, 154bl, 287tr; 94tr; **Dennis Gilbert:** 106tc; **Hulsta:** 70t; **Ideal Standard Ltd:** 72r; **The Image Bank/Getty Images:** 58; **Impact Photos:** Eliza Armstrong 115cr; John Arthur 190tl; Philip Achache 246t; **The Interior Archive:** Henry Wilson, Alfie's Market 114bl; Luke White, Architect: David Mikhail, 59tl; Simon Upton, Architect: Phillippe Starck, St Martins Lane Hotel 100bcr, 100br; **Jason Hawkes Aerial Photography:** 216t; **Dan Johnson:** 26cbl, 35r; **Kos Pictures Source:** 215cbl, 240tc, 240tr; David Williams 216b; **Lebrecht Collection:** Kate Mount 169bc; **MP Visual.com:** Mark Swallow 202t; **NASA:** 280cr, 280ccl, 281tl; **P&O Princess Cruises:** 214bl; **P A Photos:** 181br; **The Photographers' Library:** 186bl, 186bc, 186t; **Plain and Simple Kitchens:** 66t; **Powerstock Photolibrary:** 169tl, 256t, 287tc; **Rail Images:** 208c, 208 cbl, 209br; **Red Consultancy:** Odeon cinemas 257br; **Redferns:** 259br; Nigel Crane 259c; **Rex Features:** 106br, 259tc, 259tr, 259bl, 280b; Charles Ommaney 114tcr; J.F.F Whitehead 243cl; Patrick Barth 101tl; Patrick Frilet 189cbl; Scott Wiseman 287bl; **Royalty Free Images:** Getty Images/Eyewire 154bl; **Science & Society Picture Library:** Science Museum 202b; **Skyscan:** 168t, 182c, 298; Quick UK Ltd 212; **Sony:** 268bc; **Robert Streeter:** 154br; **Neil Sutherland:** 82tr, 83tl, 90t, 118, 188ctr, 196tl, 196tr, 299cl, 299bl; **The Travel Library:** Stuart Black 264t; **Travelex:** 97cl; **Vauxhall:** Technik 198t, 199tl, 199tr, 199cl, 199cr, 199ctcl, 199ctcr, 199tcl, 199tcr, 200; **View Pictures:** Dennis Gilbert, Architects: ACDP Consulting, 106t; Dennis Gilbert, Chris Wilkinson Architects, 209tr; Peter Cook, Architects: Nicholas Crimshaw and partners,

208t; **Betty Walton:** 185br; **Colin Walton:** 2, 4, 7, 9, 10, 28, 42, 56, 92, 95c, 99tl, 99tcl, 102, 116, 120t, 138t, 146, 150t, 160, 170, 191ctcl, 192, 218, 252, 260br, 260l, 261tr, 261c, 261cr, 271cbl, 271cbr, 271tcl, 278, 287br, 302, 401.

DK PICTURE LIBRARY:

Akhil Bahkshi; Patrick Baldwin; Geoff Brightling; British Museum; John Bulmer; Andrew Butler; Joe Cornish; Brian Cosgrove; Andy Crawford and Kit Houghton; Philip Dowell; Alistair Duncan; Gables; Bob Gathany; Norman Hollands; Kew Gardens; Peter James Kindersley; Vladimir Kozlik; Sam Lloyd; London Northern Bus Company Ltd; Tracy Morgan; David Murray and Jules Selmes; Musée Vivant du Cheval, France; Museum of Broadcast Communications; Museum of Natural History; NASA; National History Museum; Norfolk Rural Life Museum; Stephen Oliver; RNLI; Royal Ballet School; Guy Rycart; Science Museum; Neil Setchfield; Ross Simms and the Winchcombe Folk Police Museum; Singapore Symphony Orchestra; Smart Museum of Art; Tony Souter; Erik Svensson and Jeppe Wikstrom; Sam Tree of Keygrove Marketing Ltd; Barrie Watts; Alan Williams; Jerry Young.

Additional Photography by Colin Walton.

Colin Walton would like to thank:

A&A News, Uckfield; Abbey Music, Tunbridge Wells; Arena Mens Clothing, Tunbridge Wells; Burrells of Tunbridge Wells; Gary at Di Marco's; Jeremy's Home Store, Tunbridge Wells; Noakes of Tunbridge Wells; Ottakar's, Tunbridge Wells; Selby's of Uckfield; Sevenoaks Sound and Vision; Westfield, Royal Victoria Place, Tunbridge Wells.

All other images are Dorling Kindersley copyright. For further information see www.dkimages.com